

	Seite		Seite		Seite
WALZSTAHL / QUALITÄTSSTAHL / EDELSTAHL / NE-METALLE					
1 Formstahl Breitflanschträger	4-7	Geländerrohrbogen	58	Bleche	95-96
HEB	4	Abdeckteller	59	Edelstahlzubehör	97-102
HEA	4	Klöpferboden	59	Edelstahlbogen Einnah	97
HEM	5	Abdeckkappe	59	Abdeckteller	97
UNP	5	Ronde	59	Ronde	97
UPE	5	Hohlkugel	60	Rohr-Abschlussstopfen	98
INP	6	Massivkugel	60	Rohr-Kugelstopfen	98
IPE	6	Zackenleiste	61	Rohr-Anschlussplatte	98
Schnittschemata Träger	7	Kunststoffhandlauf	61	Handlaufträger	99
2 Stabstahl S235JR	8-20	5 Spezialprofile	62-70	Handlaufträgerstütze	99
Flachstahl	8-9	U-Baustahl	62	Gelenkstift mit Gewinde	99
Breitflachstahl	10-11	U-Bordwandprofil	62	Querstabhalter	99
Flachstahl (Bandstahl)	12	Trennwand-Markisenprofil	63	Rohr-Verbindungsstück	99
Rundstahl	12	C-Profil	63	Rohrecke 90°	100
Vierkantstahl	13	Brückengeländerhandlauf	63	Wandrosette	100
T-Stahl	13	Winkelstahl	64	Massivkugel	100
U-Stahl	13	Winkelähnlicher Stahl	64	Hohlkugel	100
Winkelstahl	14-15	Bodenbelagswinkel	64	ESG-Klemmbefestigung	100
Schnittschemata Winkel	16-17	Rolladen-U-Stahl	65	Muffe	101
Flachstahl feuerverzinkt	18	U-Stahl scharfkantig	65	Anschweissnippel	101
Rundstahl feuerverzinkt	18	Wellengitter-U-Stahl	65	Winkel	101
Vierkantstahl feuerverzinkt	19	Gitter-U-Stahl (Hespenstahl)	65	T-Stück	101
T-Stahl feuerverzinkt	19	T-Stahl	66	9 Aluminium	103-110
U-Stahl feuerverzinkt	19	Z-Stahl	66	Flach	103
Formstahl UNP / IPE feuerverz.	19	Handleistenstahl	67	Rund	104
Winkelstahl feuerverzinkt	20	Halbrundstahl	67	Vierkant	104
Breitflachstahl feuerverzinkt	20	Flachhalbrundstahl	67	U-Profil	104
3 Flachprodukte S235JR / S355MC	21-32	Flachovalstahl	67	T-Profil	105
Feinblech kaltg. / geb. + gef.	21	Scheuerleistenprofil	68	Winkel	105
Blech gebeizt gefettet	21	Kipper-Z-Profil	68	Quadrat- und Rechteckrohr	106
Bandblech / Quartoblech	22	Treppenschutzschiene	68	Rundrohr	106
Tränenblech	23	Wellengitter	69	Bohr- u. Drehqu. flach / rund / vierk.	107
Wetterfestes Blech	23	Schweissgitter	69	Bleche	108-110
Sendzimirverzinktes Blech	24	Schlossermatte	70	10 Kupfer	111
Titanzinkblech	24	Gittermatte	70	Rund	111
Elektrolytisch verzinktes Feinblech	24	6 Qualitätsstahl	71-75	Vierkant	111
Verschleissfestes Blech	25	Flachstahl	71-72	Blech halbhart	111
Lochblech QG	26-28	Rundstahl	73	Rotguss rund	111
Lochblech RG / RV	-31	Vierkantstahl	73	11 Messing	112
Einfassprofil T / Rund / Rechteck	32	T-Stahl	73	Rund	112
Skizze Lochbleche	32	Winkelstahl	74	Vierkant	112
4 Stahlrohre	33-57	Breitflachstahl	74	Blech	112
Quadrat-/Rechteckr. schw./blank	33-36	Formstahl, U-Stahl, UNP	75	Massivkugel	112
Profilrohr Möbelbau blank	36	Vergütungsstahl flach, breitflach	75	Hohlkugel	112
Quadrat-/Rechteckrohr verzinkt	37-38	7 Blank- und Edelbaustahl	76-85		
Stahlbauhohlprofil kaltgefertigt	39-41	Flachstahl	76-79	BEWEHRUNGSTECHNIK / HALFEN	113-136
Stahlbauhohlprofil warmgefertigt	42	Rundstahl	79-82		
Schnittschemata Stahlbauhohlprofil	43-44	Automatenstahl rund	82	GITTERROSTE	137-155
Gewinderohr	45-46	Vierkantstahl	83		
Geländerrohr / Konstruktionsrohr	46	Sechskantstahl	83-84	SANDWICHPANEELE / TRAPEZBLECHE	157-171
Stahlrohr geschweisst + nahtlos	47-48	Dreikantstahl	84		
Präzisionsrohr geschweisst	48	Winkelstahl	84		
Präzisionsrohr nahtlos	49	Keilstahl flach	85		
Hydraulikleitungsrohr	50	Keilstahl vierkant	85		
Flachovalrohr	50	Silberstahl rund	85		
Anschlagrohre RP	51-55	8 Edelstahl	86-96		
Klemmschrauben	56	Flachstahl	86-88		
Glashalteleisten	56-57	Rundstahl	89-90		
Dichtungsprofile	57	Vierkantstahl	90-91		
Stahlzubehör	58-61	Sechskantstahl	91		
Siederrohrbogen	58	U-Profil	91		
		Winkelstahl	91-92		
		Quadratrohr	92		
		Rechteckrohr	93		
		Rundrohr	93-94		

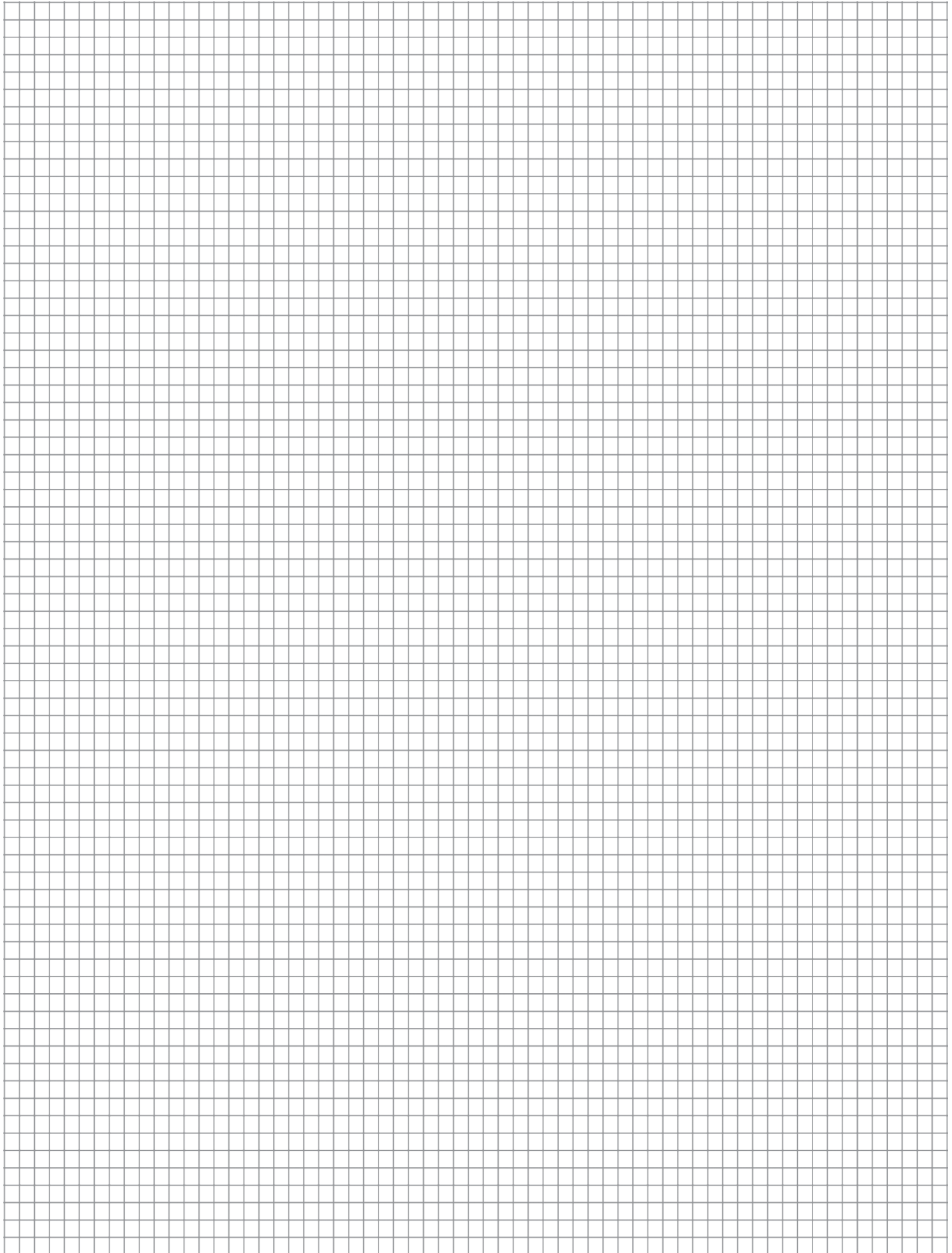



WALZSTAHL
QUALITÄTSSTAHL
EDELSTAHL
NE-METALLE

BREITFLANSCHTRÄGER HEB S235JR
DIN 1025/EN10025

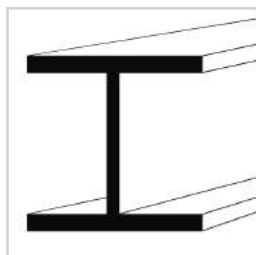

	kg/mtr	6.1 mtr	11.1 mtr	12.1 mtr	13.1 mtr	14.1 mtr	15.1 mtr	16.1 mtr	17.1 mtr	18.1 mtr	19.1 mtr	20.1 mtr
HEB 100	20,900		X	X	X	X	X	X				
HEB 120	27,400		X	X	X	X	X	X		X		
HEB 140	34,500		X	X	X	X	X	X		X		
HEB 160	43,700		X	X	X	X	X	X		X		
HEB 180	52,500		X	X	X	X	X	X		X		
HEB 200	63,000		X	X	X	X	X	X		X		
HEB 220	73,000		X	X	X	X	X	X		X		
HEB 240	85,000		X	X	X	X	X	X		X		
HEB 260	95,000		X	X	X	X	X	X		X		
HEB 280	106,000		X	X	X		X	X		X		
HEB 300	120,000		X	X	X	X	X	X		X		
HEB 320	130,000		X	X		X	X	X	X	X		
HEB 340	137,000		X	X		X	X	X	X	X		
HEB 360	146,000		X	X		X	X	X	X	X		
HEB 400	159,000		X	X		X	X	X	X	X		
HEB 450	175,000		X	X		X	X				X	
HEB 500	192,000		X			X	X				X	
HEB 550	204,000		X	X				X	X	X		
HEB 600	217,000			X				X				

BREITFLANSCHTRÄGER HEA S235JR
DIN 1025/EN10025

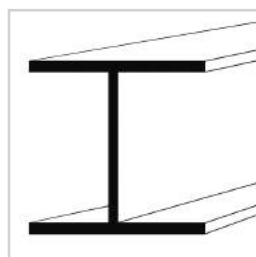

	kg/mtr	6.1 mtr	11.1 mtr	12.1 mtr	13.1 mtr	14.1 mtr	15.1 mtr	16.1 mtr	17.1 mtr	18.1 mtr	19.1 mtr	20.1 mtr
HEA 100	17,100		X	X	X	X	X	X				
HEA 120	20,400		X	X	X	X	X	X		X		
HEA 140	25,300		X	X	X	X	X	X		X		
HEA 160	31,200		X	X	X	X	X	X		X		
HEA 180	36,400		X	X	X	X	X	X		X		
HEA 200	43,000		X	X	X	X	X	X		X		
HEA 220	52,000		X	X	X	X	X	X		X		
HEA 240	62,000		X	X	X	X	X	X		X		
HEA 260	70,000		X	X	X	X	X	X		X		
HEA 280	78,000		X	X	X		X	X		X		
HEA 300	90,000		X	X	X	X	X	X		X		
HEA 320	100,000		X	X		X	X	X	X	X		
HEA 340	108,000		X	X		X	X	X	X	X		
HEA 360	115,000		X	X		X	X	X	X	X		
HEA 400	128,000		X	X		X	X	X	X	X		
HEA 450	143,000		X				X				X	
HEA 500	159,000		X				X				X	
HEA 550	170,000		X	X			X	X	X	X		
HEA 600	182,000						X					

Wir erweitern ständig unser Lagerprogramm, nicht aufgeführte Abmessungen sind auf Anfrage lieferbar.

BREITFLANSCHTRÄGER HEM S235JR
DIN 1025/EN10025

	kg/mtr	6.1 mtr	11.1 mtr	12.1 mtr	13.1 mtr	14.1 mtr	15.1 mtr	16.1 mtr	17.1 mtr	18.1 mtr	19.1 mtr	20.1 mtr
HEM 100	42,800			X		X	X					
HEM 120	53,400			X		X	X					
HEM 140	64,800			X		X	X					
HEM 160	78,100			X		X	X			X		
HEM 180	91,100			X		X	X			X		
HEM 200	106,000			X		X	X			X		
HEM 220	120,000			X		X	X			X		
HEM 240	161,000			X		X	X			X		
HEM 260	176,000						X			X		
HEM 280	194,000						X			X		
HEM 300	244,000						X			X		

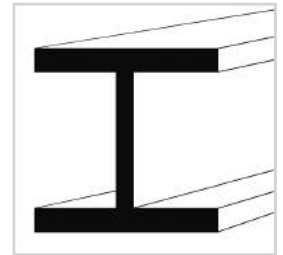
FORMSTAHL UNP S235JR
DIN 1026/EN10025

	kg/mtr	6.1 mtr	11.1 mtr	12.1 mtr	13.1 mtr	14.1 mtr	15.1 mtr	16.1 mtr	17.1 mtr	18.1 mtr	19.1 mtr	20.1 mtr
UNP 80	8,900	X		X		X						
UNP 100	10,900	X		X		X	X					
UNP 120	13,700	X		X		X	X	X				
UNP 140	16,400	X		X		X	X	X				
UNP 160	19,300	X		X		X	X	X				
UNP 180	22,500			X		X	X	X				
UNP 200	26,000			X		X	X			X		
UNP 220	30,000			X		X	X			X		
UNP 240	34,000			X		X	X			X		
UNP 260	39,000			X		X	X			X		
UNP 280	43,000			X		X	X			X		
UNP 300	48,000			X		X	X			X		
UNP 320	61,000			X			X			X		
UNP 350	62,000			X			X			X		
UNP 380	65,000			X			X			X		
UNP 400	74,000			X			X			X		

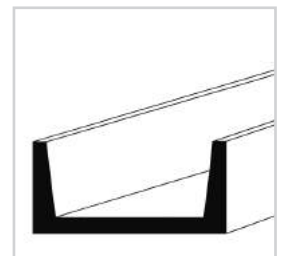
FORMSTAHL UPE S235JR
DIN 1026/EN10025

	kg/mtr	6.1 mtr	11.1 mtr	12.1 mtr	13.1 mtr	14.1 mtr	15.1 mtr	16.1 mtr	17.1 mtr	18.1 mtr	19.1 mtr	20.1 mtr
UPE 80	8,100			X			X					
UPE 100	10,100			X			X					
UPE 120	12,400			X			X					
UPE 140	14,800			X			X					
UPE 160	17,400			X			X					
UPE 180	20,200			X			X					
UPE 200	23,300			X			X					

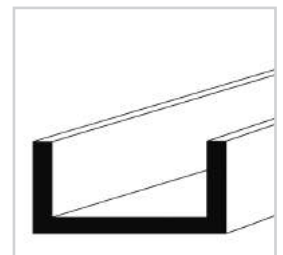

Wir erweitern ständig unser Lagerprogramm, nicht aufgeführte Abmessungen sind auf Anfrage lieferbar.

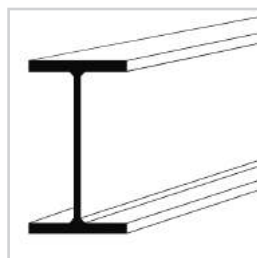

FORMSTAHL IPE S235JR
DIN 1025/EN10025

	kg/mtr	6.1 mtr	11.1 mtr	12.1 mtr	13.1 mtr	14.1 mtr	15.1 mtr	16.1 mtr	17.1 mtr	18.1 mtr	19.1 mtr	20.1 mtr
IPE 80	6,200	X		X		X						
IPE 100	8,300	X		X		X	X					
IPE 120	10,700	X		X	X	X	X	X				
IPE 140	13,200			X	X	X	X	X				
IPE 160	16,200			X	X	X	X	X				
IPE 180	19,300			X	X	X	X	X				
IPE 200	23,000			X	X	X	X			X		
IPE 220	26,900			X	X	X	X			X		
IPE 240	31,500		X	X	X	X	X			X		
IPE 270	37,000		X	X	X	X	X			X		
IPE 300	43,300		X	X	X	X	X			X		
IPE 330	50,400		X	X	X	X	X			X		
IPE 360	58,600		X	X	X	X	X			X		
IPE 400	68,000		X	X	X	X	X			X		
IPE 450	80,000		X	X	X	X	X			X		
IPE 500	93,000		X	X	X	X	X			X		
IPE 550	109,000		X					X		X		
IPE 600	125,000		X					X		X		

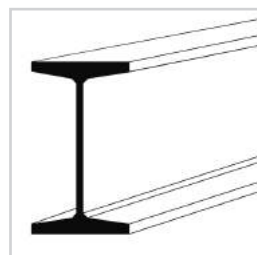

FORMSTAHL INP S235JR
DIN 1025/EN10025

	kg/mtr	6.1 mtr	11.1 mtr	12.1 mtr	13.1 mtr	14.1 mtr	15.1 mtr	16.1 mtr	17.1 mtr	18.1 mtr	19.1 mtr	20.1 mtr
INP 80	6,100			X								
INP 100	8,500			X								
INP 120	11,500			X								
INP 140	14,700			X								
INP 160	18,500			X								
INP 180	22,500			X			X					
INP 200	27,000			X								
INP 220	32,000			X								
INP 240	37,000			X								
INP 260	43,000			X								
INP 280	49,000			X								
INP 300	56,000			X								
INP 340	70,000			X								
INP 360	78,000			X								
INP 400	95,000			X								

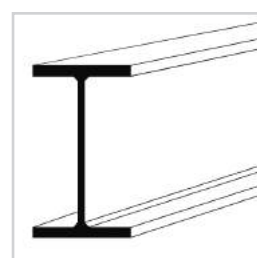

FORMSTAHL IPE S355J2
DIN 1025/EN10025

	kg/mtr	6.1 mtr	11.1 mtr	12.1 mtr	13.1 mtr	14.1 mtr	15.1 mtr	16.1 mtr	17.1 mtr	18.1 mtr	19.1 mtr	20.1 mtr
IPE 80	6,200			X								
IPE 100	8,300			X								
IPE 120	10,700			X								
IPE 140	13,200			X								

Wir erweitern ständig unser Lagerprogramm, nicht aufgeführte Abmessungen sind auf Anfrage lieferbar.

■ SCHNITTSCHEMATA I-TRÄGER

INP, IPE, HEB, HEA, HEM

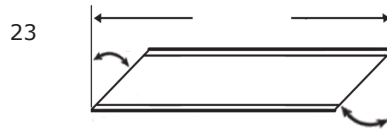
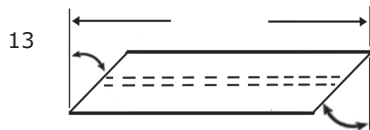
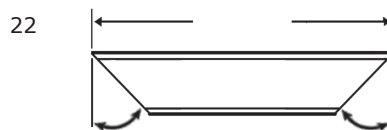
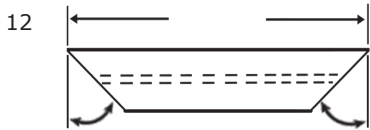
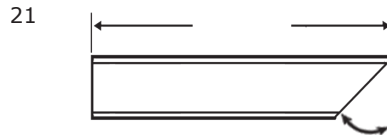
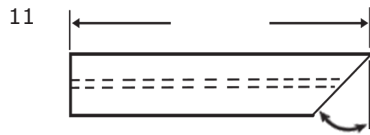

Grundrisse
Träger von oben betrachtet
Schnittschemata
Gehrungsschnitte bis max. 60°
Bitte geben Sie die Nummer
des gewünschten Schnittschemas
bei Ihrer Bestellung an.

■ SCHNITTSCHEMATA U-TRÄGER

UNP

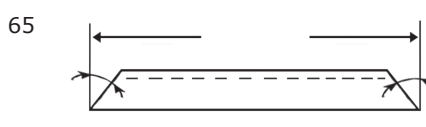
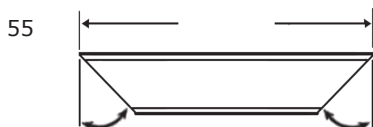
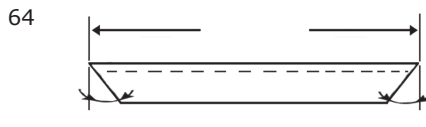
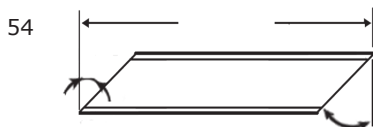
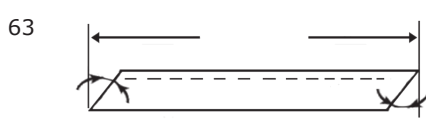
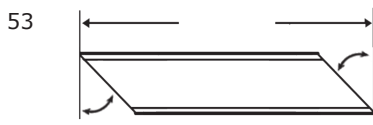
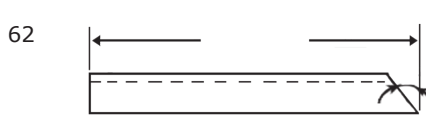
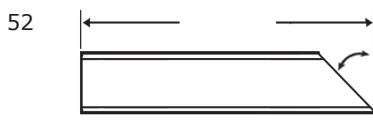
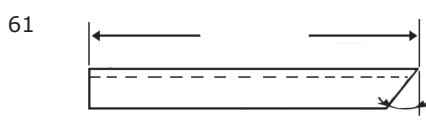
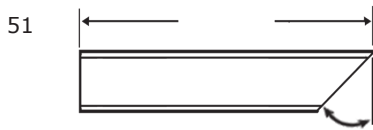

■ **FLACHSTAHL S235JR**
EN10058/EN10025

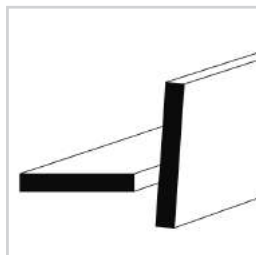

mm	mm	6 mtr	kg/mtr	mm	mm	6 mtr	kg/mtr
10	5	X	0,393	40	30	X	9,420
10	6	X	0,472	45	5	X	1,770
12	5	X	0,471	45	6	X	2,120
12	6	X	0,565	45	8	X	2,830
12	8	X	0,754	45	10	X	3,530
14	5	X	0,550	45	12	X	4,240
14	6	X	0,660	45	15	X	5,300
14	8	X	0,880	45	20	X	7,070
15	5	X	0,589	45	25	X	8,830
15	6	X	0,707	45	30	X	10,600
15	8	X	0,942	50	5	X	1,960
15	10	X	1,180	50	6	X	2,360
16	5	X	0,628	50	8	X	3,140
16	6	X	0,754	50	10	X	3,930
16	8	X	1,000	50	12	X	4,710
16	10	X	1,260	50	15	X	5,890
18	5	X	0,707	50	20	X	7,850
18	6	X	0,848	50	25	X	9,810
18	8	X	1,130	50	30	X	11,800
20	5	X	0,785	50	40	X	15,700
20	6	X	0,942	55	5	X	2,160
20	8	X	1,260	55	6	X	2,590
20	10	X	1,570	55	8	X	3,450
20	12	X	1,880	55	10	X	4,320
20	15	X	2,360	55	12	X	5,180
25	5	X	0,981	55	15	X	6,480
25	6	X	1,180	55	20	X	8,640
25	8	X	1,570	55	25	X	10,800
25	10	X	1,960	60	5	X	2,360
25	12	X	2,360	60	6	X	2,830
25	15	X	2,940	60	8	X	3,770
25	20	X	3,930	60	10	X	4,710
30	5	X	1,180	60	12	X	5,650
30	6	X	1,410	60	15	X	7,070
30	8	X	1,880	60	20	X	9,420
30	10	X	2,360	60	25	X	11,800
30	12	X	2,830	60	30	X	14,100
30	15	X	3,530	60	35	X	16,500
30	20	X	4,710	60	40	X	18,800
30	25	X	5,890	60	50	X	23,600
35	5	X	1,370	65	5	X	2,550
35	6	X	1,650	65	6	X	3,060
35	8	X	2,200	65	8	X	4,080
35	10	X	2,750	65	10	X	5,100
35	12	X	3,300	65	12	X	6,120
35	15	X	4,120	65	15	X	7,650
35	20	X	5,500	65	20	X	10,200
35	25	X	6,870	65	25	X	12,800
40	5	X	1,570	70	5	X	2,750
40	6	X	1,880	70	6	X	3,300
40	8	X	2,510	70	8	X	4,400
40	10	X	3,140	70	10	X	5,500
40	12	X	3,770	70	12	X	6,590
40	15	X	4,710	70	15	X	8,240
40	20	X	6,280	70	20	X	11,000
40	25	X	7,850				



Wir erweitern ständig unser Lagerprogramm, nicht aufgeführte Abmessungen sind auf Anfrage lieferbar.

FLACHSTAHL S235JR
EN10058/EN10025

mm	mm	6 mtr	kg/mtr	mm	mm	6 mtr	kg/mtr
70	25	X	13,700	110	15	X	13,000
70	30	X	16,500	110	20	X	17,300
70	35	X	19,200	110	25	X	21,600
70	40	X	22,000	110	30	X	25,910
70	50	X	27,500	110	40	X	34,500
75	5	X	2,940	110	50	X	43,200
75	6	X	3,530	110	60	X	51,820
75	8	X	4,710	120	5	X	4,710
75	10	X	5,890	120	6	X	5,652
75	12	X	7,070	120	8	X	7,540
75	15	X	8,830	120	10	X	9,420
75	20	X	11,800	120	12	X	11,300
75	25	X	14,700	120	15	X	14,100
80	5	X	3,140	120	20	X	18,800
80	6	X	3,770	120	25	X	23,600
80	8	X	5,020	120	30	X	28,300
80	10	X	6,280	120	40	X	37,700
80	12	X	7,540	120	50	X	47,100
80	15	X	9,420	120	60	X	56,500
80	20	X	12,600	130	5	X	5,103
80	25	X	15,700	130	6	X	6,123
80	30	X	18,800	130	8	X	8,160
80	40	X	25,120	130	10	X	10,200
80	50	X	31,400	130	12	X	12,200
80	60	X	37,700	130	15	X	15,300
90	5	X	3,530	130	20	X	20,400
90	6	X	4,240	130	25	X	25,500
90	8	X	5,650	130	30	X	30,600
90	10	X	7,070	130	40	X	40,800
90	12	X	8,480	130	50	X	51,000
90	15	X	10,600	130	60	X	61,230
90	20	X	14,100	140	5	X	5,495
90	25	X	17,700	140	6	X	6,594
90	30	X	21,200	140	8	X	8,790
90	40	X	28,300	140	10	X	11,000
90	50	X	35,300	140	12	X	13,200
90	60	X	42,400	140	15	X	16,500
100	5	X	3,930	140	20	X	22,000
100	6	X	4,710	140	25	X	27,500
100	8	X	6,280	140	30	X	33,000
100	10	X	7,850	140	40	X	44,000
100	12	X	9,420	140	50	X	55,000
100	15	X	11,800	140	60	X	65,950
100	20	X	15,700	150	5	X	5,888
100	25	X	19,630	150	6	X	7,065
100	30	X	23,550	150	8	X	9,420
100	35	X	27,500	150	10	X	11,800
100	40	X	31,400	150	12	X	14,100
100	50	X	39,300	150	15	X	17,700
100	60	X	47,100	150	20	X	23,600
110	5	X	4,320	150	25	X	29,400
110	6	X	5,180	150	30	X	35,300
110	8	X	6,910	150	40	X	47,100
110	10	X	8,640	150	50	X	58,900
110	12	X	10,400	150	60	X	70,700

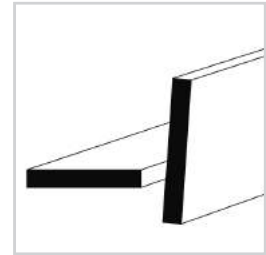

Wir erweitern ständig unser Lagerprogramm, nicht aufgeführte Abmessungen sind auf Anfrage lieferbar.

BREITFLACHSTAHL S235JR
DIN 59200/EN10025

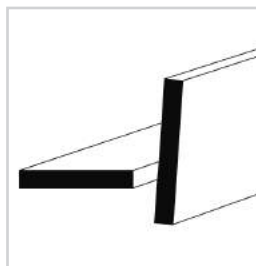

mm	mm	6 mtr	kg/mtr	mm	mm	6 mtr	kg/mtr
160	5	X	6,400	210	8	X	13,400
160	6	X	7,680	210	10	X	16,800
160	8	X	10,200	210	12	X	20,200
160	10	X	12,800	210	15	X	25,200
160	12	X	15,400	210	20	X	33,600
160	15	X	19,200	210	25	X	42,000
160	20	X	25,600	220	5	X	8,800
160	25	X	31,400	220	6	X	10,600
160	30	X	38,400	220	8	X	14,100
160	35	X	44,800	220	10	X	17,600
160	40	X	51,200	220	12	X	21,100
160	50	X	64,000	220	15	X	26,400
170	8	X	10,880	220	20	X	35,200
170	10	X	13,600	220	25	X	43,180
170	12	X	16,320	220	30	X	52,800
170	15	X	20,400	220	35	X	61,600
170	20	X	27,200	220	40	X	70,400
170	25	X	34,000	220	50	X	88,000
170	30	X	40,800	230	6	X	11,000
180	5	X	7,200	230	10	X	18,400
180	6	X	8,640	230	12	X	22,100
180	8	X	11,500	230	15	X	27,600
180	10	X	14,400	230	20	X	36,800
180	12	X	17,300	240	6	X	11,500
180	15	X	21,600	240	8	X	15,400
180	20	X	28,800	240	10	X	19,200
180	25	X	35,360	240	12	X	23,000
180	30	X	43,200	240	15	X	28,800
180	35	X	50,400	240	20	X	38,400
180	40	X	57,600	240	25	X	47,100
180	50	X	72,000	240	30	X	57,600
180	60	X	86,400	240	40	X	76,800
190	8	X	12,160	250	5	X	10,000
190	10	X	15,200	250	6	X	12,000
190	12	X	18,240	250	8	X	16,000
190	15	X	22,800	250	10	X	20,000
190	20	X	30,400	250	12	X	24,000
190	25	X	38,000	250	15	X	30,000
190	30	X	45,600	250	20	X	40,000
200	5	X	8,000	250	25	X	49,050
200	6	X	9,600	250	30	X	60,000
200	8	X	12,800	250	35	X	70,000
200	10	X	16,000	250	40	X	80,000
200	12	X	19,200	250	50	X	100,000
200	15	X	24,000	260	8	X	16,330
200	20	X	32,000	260	10	X	20,410
200	25	X	39,250	260	12	X	24,490
200	30	X	48,000	260	15	X	30,620
200	35	X	56,000	260	20	X	40,820
200	40	X	64,000	260	25	X	51,050
200	50	X	80,000	260	30	X	61,240
200	60	X	96,000				



Wir erweitern ständig unser Lagerprogramm, nicht aufgeführte Abmessungen sind auf Anfrage lieferbar.

BREITFLACHSTAHL S235JR
DIN 59200/EN10025

mm	mm	6 mtr	kg/mtr	mm	mm	6 mtr	kg/mtr
270	10	X	21,600	350	10	X	28,000
270	12	X	25,900	350	12	X	33,600
270	15	X	32,400	350	15	X	42,000
270	20	X	43,200	350	20	X	56,000
280	6	X	13,190	350	25	X	70,000
280	8	X	17,580	350	30	X	84,000
280	10	X	21,980	350	40	X	112,000
280	12	X	26,380	360	10	X	28,800
280	15	X	32,970	360	15	X	43,200
280	20	X	43,960	360	20	X	57,600
280	25	X	54,950	380	10	X	30,400
280	30	X	65,940	380	12	X	36,500
280	40	X	87,920	380	15	X	45,600
300	5	X	12,000	380	20	X	60,800
300	6	X	14,400	400	5	X	16,000
300	8	X	19,200	400	6	X	19,200
300	10	X	24,000	400	8	X	25,600
300	12	X	28,800	400	10	X	32,000
300	15	X	36,000	400	12	X	38,400
300	20	X	48,000	400	15	X	48,000
300	25	X	58,900	400	20	X	64,000
300	30	X	72,000	400	25	X	78,500
300	35	X	84,000	400	30	X	96,000
300	40	X	96,000	400	40	X	128,000
300	50	X	120,000	450	8	X	28,800
320	8	X	20,460	450	10	X	36,000
320	10	X	25,570	450	12	X	43,200
320	12	X	30,680	450	15	X	54,000
320	15	X	38,360	450	20	X	72,000
320	20	X	51,140	450	25	X	90,000
320	25	X	62,830	500	8	X	32,000
320	30	X	76,800	500	10	X	40,000
340	10	X	27,200	500	12	X	48,000
340	15	X	40,800	500	15	X	60,000
340	20	X	54,400	500	20	X	80,000
350	5	X	14,000	500	25	X	98,100
350	6	X	16,800	500	30	X	120,000
350	8	X	22,400				

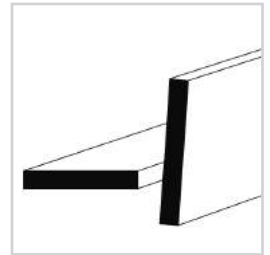

Wir erweitern ständig unser Lagerprogramm, nicht aufgeführte Abmessungen sind auf Anfrage lieferbar.

■ **FLACHSTAHL (BANDSTAHL) S235JR**
EN10058/EN10025

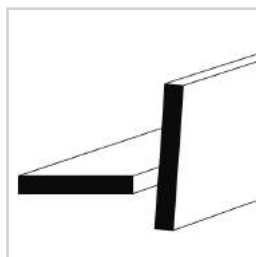

mm	mm	4 mtr	6 mtr	kg/mtr
10	3		X	0,236
10	4		X	0,314
12	3		X	0,283
12	4		X	0,377
14	3		X	0,330
15	3		X	0,353
15	4		X	0,471
16	3		X	0,377
16	4		X	0,502
18	3		X	0,425
18	4		X	0,565
20	2	X		0,314
20	3		X	0,471
20	4		X	0,628
25	2	X		0,393
25	3		X	0,589
25	4		X	0,785
30	2	X		0,471
30	3		X	0,707
30	4		X	0,942
35	3		X	0,824
35	4		X	1,100

mm	mm	4 mtr	6 mtr	kg/mtr
40	2	X		0,628
40	3		X	0,942
40	4		X	1,260
45	3		X	1,060
45	4		X	1,413
50	2	X		0,785
50	3		X	1,178
50	4		X	1,570
60	3		X	1,413
60	4		X	1,884
70	3		X	1,649
70	4		X	2,198
80	3		X	1,884
80	4		X	2,512
90	3		X	2,120
90	4		X	2,826
100	3		X	2,355
100	4		X	3,140
120	3		X	2,820
120	4		X	3,768
150	4		X	4,710

■ **RUNDSTAHL S235JR**
EN10060/EN10025

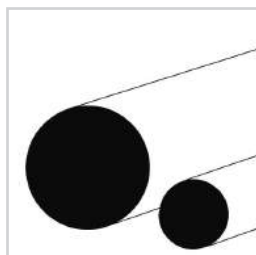

mm	6 mtr	kg/mtr
6	X	0,222
8	X	0,395
10	X	0,617
12	X	0,888
14	X	1,210
15	X	1,390
16	X	1,580
18	X	2,000
20	X	2,470
22	X	2,980
24	X	3,550
25	X	3,850
26	X	4,170
27	X	4,490
28	X	4,830
30	X	5,550
32	X	6,310
35	X	7,550

mm	6 mtr	kg/mtr
36	X	7,990
40	X	9,860
42	X	10,900
45	X	12,500
48	X	14,200
50	X	15,400
55	X	18,700
60	X	22,200
65	X	26,000
70	X	30,200
80	X	39,500
85	X	44,500
90	X	49,900
95	X	55,600
100	X	61,700
110	X	74,600
120	X	88,800

Wir erweitern ständig unser Lagerprogramm, nicht aufgeführte Abmessungen sind auf Anfrage lieferbar.

VIERKANTSTAHL S235JR
EN10059/EN10025

mm	6 mtr	kg/mtr
6	X	0,283
8	X	0,502
10	X	0,785
12	X	1,130
13	X	1,330
14	X	1,540
15	X	1,770
16	X	2,010
18	X	2,540
20	X	3,140
22	X	3,800
24	X	4,520
25	X	4,910

mm	6 mtr	12 mtr	kg/mtr
30	X		7,070
35	X		9,620
40	X		12,600
45	X		15,900
50	X		19,600
60	X		28,300
65	X		33,200
70	X		38,500
80	X		50,200
90	X		63,600
100	X		78,500
120		X	113,000

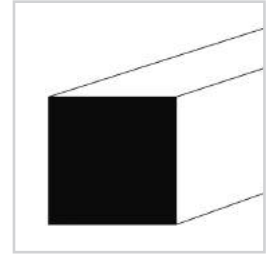

T-STAH L S235JR
EN10055/EN10025

mm	mm	mm	6 mtr	12 mtr	kg/mtr
20	20	3	X		0,880
25	25	3,5	X		1,290
30	30	4	X		1,770
35	35	4,5	X		2,330
40	40	5	X		2,960
45	45	5,5	X		3,670
50	50	6	X	X	4,440

mm	mm	mm	6 mtr	12 mtr	kg/mtr
60	60	7	X	X	6,230
70	70	8	X	X	8,320
80	80	9	X	X	10,700
90	90	10	X	X	13,400
100	100	11	X	X	16,400
120	120	13	X	X	23,200
140	140	15	X	X	31,300

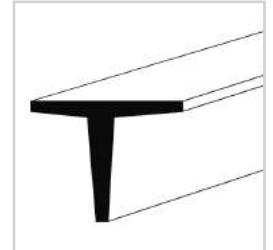

U-STAH L S235JR
DIN 1026/EN10025

mm	mm	mm	6 mtr	12 mtr	kg/mtr
30	15	4	X		1,790
30	33	5	X		4,400
35	17,5	4	X		2,160
40	20	5	X		2,960
40	35	5	X	X	5,020

mm	mm	mm	6 mtr	12 mtr	kg/mtr
50	25	5	X		3,980
50	38	5	X	X	5,760
60	30	6	X	X	5,220
65	42	5,5	X	X	7,300
70	40	6	X		6,720

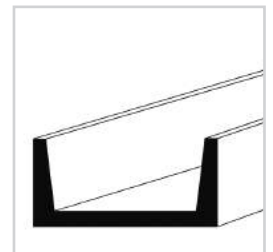

Wir erweitern ständig unser Lagerprogramm, nicht aufgeführte Abmessungen sind auf Anfrage lieferbar.

WINKELSTAHL S235JR GLEICHSCHENKLIG
EN10056/EN10025

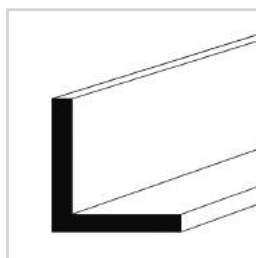

mm	mm	6 mtr	12 mtr	kg/mtr	mm	mm	6 mtr	12 mtr	kg/mtr
15	3	X		0,640	80	6	X	X	7,340
20	3	X		0,880	80	8	X	X	9,660
20	4	X		1,140	80	10	X	X	11,900
25	3	X		1,120	80	12	X	X	14,100
25	4	X		1,450	90	6	X	X	8,320
25	5	X		1,770	90	7		X	9,610
30	3	X		1,360	90	9	X	X	12,200
30	4	X		1,780	90	11		X	14,700
30	5	X		2,180	100	6	X	X	9,410
35	3	X		1,600	100	8	X	X	12,200
35	4	X		2,100	100	10	X	X	15,100
35	5	X		2,570	100	12	X	X	17,800
35	6	X		3,040	100	14	X	X	20,600
40	3	X		1,840	110	10	X	X	16,600
40	4	X	X	2,420	120	8	X	X	14,700
40	5	X		2,970	120	10	X	X	18,200
40	6	X		3,520	120	11		X	19,900
45	4	X		2,740	120	12	X	X	21,600
45	5	X		3,380	120	15	X	X	26,600
45	6	X		4,000	130	12	X	X	23,600
50	4	X		3,060	140	13		X	27,500
50	5	X	X	3,770	140	15		X	31,400
50	6	X		4,470	150	10	X	X	22,770
50	7	X		5,150	150	12	X	X	27,300
50	8	X		5,820	150	14		X	31,600
50	9	X		6,470	150	15		X	33,800
55	6	X		4,950	160	15	X	X	36,200
60	5	X		4,570	160	17		X	40,700
60	6	X	X	5,420	180	16		X	43,500
60	8	X	X	7,090	180	18		X	48,600
60	10	X		8,690	200	16	X	X	48,500
65	7	X		6,830	200	20		X	59,900
65	9	X		8,620	200	24		X	71,100
70	6	X		6,380	250	18		X	68,400
70	7	X	X	7,380	250	20		X	75,700
70	9	X	X	9,340	250	24		X	90,000
75	7	X		7,940	250	28		X	104,000
75	8	X		9,030					

Wir erweitern ständig unser Lagerprogramm, nicht aufgeführte Abmessungen sind auf Anfrage lieferbar.

WINKELSTAHL S235JR UNGLEICHSCHENKLIG
EN10056/EN10025

mm	mm	mm	6 mtr	12 mtr	kg/mtr	mm	mm	mm	6 mtr	12 mtr	kg/mtr
30	20	3	X		1,110	100	50	6	X	X	6,850
30	20	4	X		1,450	100	50	8	X	X	8,990
40	20	3	X		1,350	100	50	10	X	X	11,100
40	20	4	X		1,770	100	65	7	X	X	8,770
40	25	4	X		1,930	100	65	9	X	X	11,100
45	30	4	X		2,250	100	65	11	X	X	13,400
45	30	5	X		2,770	100	75	7	X	X	9,320
50	30	4	X		2,410	100	75	9	X	X	11,800
50	30	5	X		2,960	100	75	11		X	14,300
50	40	4	X		2,710	120	80	8	X	X	12,200
50	40	5	X		3,350	120	80	10	X	X	15,000
60	30	5	X		3,370	120	80	12	X	X	17,800
60	30	6	X		3,980	130	65	8	X	X	11,900
60	30	7	X		4,590	130	65	10	X	X	14,600
60	40	5	X	X	3,760	130	65	12	X	X	17,300
60	40	6	X	X	4,460	130	90	10		X	16,600
60	40	7	X		5,140	130	90	12		X	19,700
65	50	5	X		4,350	150	75	9	X	X	15,300
65	50	7	X	X	5,970	150	75	11	X	X	18,600
65	50	8	X	X	6,750	150	90	10		X	18,200
70	50	6	X		5,400	150	90	12		X	21,600
75	50	5	X		4,740	150	100	10	X	X	19,000
75	50	6		X	5,400	150	100	12	X	X	22,600
75	50	7	X		6,510	150	100	14		X	26,100
75	50	8		X	7,490	160	80	10	X	X	18,200
75	50	9		X	8,230	160	80	12	X	X	21,600
75	55	5	X		4,950	160	80	14		X	25,000
75	55	7	X	X	6,800	180	90	10	X	X	20,600
75	55	9	X		8,590	180	90	12	X	X	24,500
80	40	6	X	X	5,410	200	100	10	X	X	23,000
80	40	8	X	X	7,070	200	100	12	X	X	27,300
80	60	7	X	X	7,360	200	100	14	X	X	31,600
80	65	6	X		6,600	200	100	16		X	35,900
80	65	8	X	X	8,660	250	90	10	X	X	26,100
80	65	10	X	X	10,700	250	90	12		X	31,100
90	60	6	X	X	6,820	250	90	14		X	36,000
90	60	8	X	X	8,960	250	90	16		X	40,900

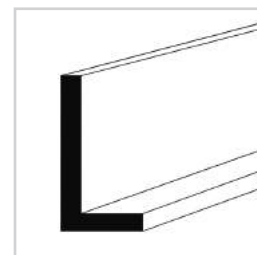

■ **SCHNITTSCHEMATA WINKEL**

Winkel gleich- oder ungleichschenkelig; Grundriss von oben betrachtet



■ **SCHNITTSCHEMATA WINKEL**

Winkel ungleichschenkelig; Grundriss von oben betrachtet



FLACHSTAHL S235JR FEUERVERZINKT
EN10058/EN10025

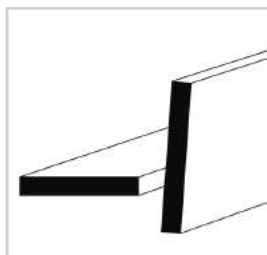

mm	mm	6 mtr	kg/mtr	mm	mm	6 mtr	kg/mtr
20	3	X	0,500	60	4	X	1,980
20	4	X	0,660	60	5	X	2,480
20	5	X	0,830	60	6	X	2,980
20	6	X	0,990	60	8	X	3,960
20	8	X	1,330	60	10	X	4,950
20	10	X	1,640	60	12	X	5,940
20	12	X	1,974	60	15	X	7,430
25	3	X	0,620	65	10	X	5,330
25	4	X	0,830	70	6	X	3,470
25	5	X	1,030	70	8	X	4,620
25	6	X	1,240	70	10	X	5,780
25	8	X	1,650	80	5	X	3,300
30	3	X	0,750	80	6	X	3,960
30	4	X	0,990	80	8	X	5,280
30	5	X	1,240	80	10	X	6,600
30	6	X	1,500	80	12	X	7,920
30	8	X	1,980	80	15	X	9,900
30	10	X	2,480	100	5	X	4,088
35	5	X	1,440	100	6	X	4,950
35	6	X	1,740	100	8	X	6,600
35	8	X	2,310	100	10	X	8,250
40	3	X	0,987	100	12	X	9,900
40	4	X	1,330	100	15	X	12,350
40	5	X	1,650	100	20	X	16,500
40	6	X	1,980	120	5	X	4,895
40	8	X	2,640	120	6	X	5,933
40	10	X	3,300	120	8	X	7,840
45	6	X	2,230	120	10	X	9,790
45	8	X	2,940	120	15	X	14,700
50	3	X	1,239	140	6	X	6,930
50	4	X	1,650	140	10	X	11,550
50	5	X	2,060	150	5	X	6,070
50	6	X	2,480	150	6	X	7,191
50	8	X	3,300	150	8	X	9,610
50	10	X	4,130	150	10	X	12,241
50	12	X	4,950	150	25	X	30,912
55	8	X	3,623				

RUNDSTAHL S235JR FEUERVERZINKT
EN10060/EN10025

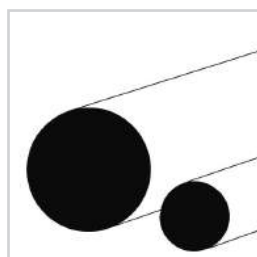

mm	6 mtr	kg/mtr	mm	6 mtr	kg/mtr
6	X	0,240	15	X	1,460
8	X	0,420	16	X	1,660
10	X	0,650	18	X	2,100
12	X	0,940	20	X	2,600
14	X	1,270	25	X	4,043

Wir erweitern ständig unser Lagerprogramm, nicht aufgeführte Abmessungen sind auf Anfrage lieferbar.

VIERKANTSTAHL S235JR FEUERVERZINKT

EN10059/EN10025

mm	6 mtr	kg/mtr	mm	6 mtr	kg/mtr
8	X	0,527	15	X	1,860
10	X	0,830	16	X	2,110
12	X	1,190	20	X	3,300
14	X	1,620	30	X	7,350

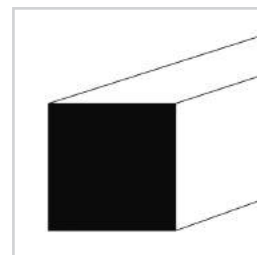

T-STAHL S235JR FEUERVERZINKT

EN10055/EN10025

mm	mm	mm	6 mtr	kg/mtr	mm	mm	mm	6 mtr	kg/mtr
30	30	4	X	1,860	50	50	6	X	4,670
35	35	4,5	X	2,480	60	60	7	X	6,550
40	40	5	X	3,110	70	70	8	X	8,740
45	45	5,5	X	3,817	80	80	9	X	11,240

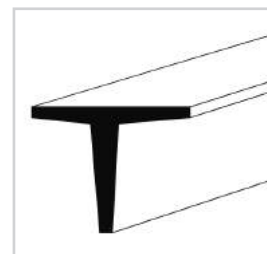

U-STAHL S235JR FEUERVERZINKT

DIN 1026/EN10025

mm	mm	mm	6 mtr	kg/mtr	mm	mm	mm	6 mtr	kg/mtr
30	15	4	X	1,830	50	38	5	X	6,050
40	20	5	X	3,110	60	30	6	X	5,490
40	35	5	X	5,280	65	42	5,5	X	7,670
50	25	5	X	4,180					

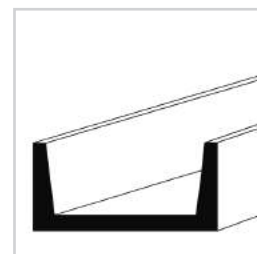

FORMSTAHL UNP S235JR FEUERVERZINKT

DIN 1026/EN10025

mm	6 mtr	kg/mtr
80	X	9,350
100	X	11,450
120	X	14,390
140	X	17,220
160	X	20,270

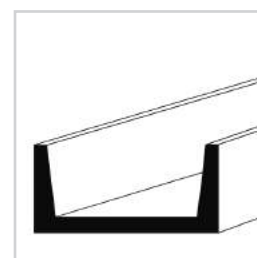

FORMSTAHL IPE S235JR FEUERVERZINKT

DIN 1025/EN10025

mm	6.1 mtr	kg/mtr
80	X	6,386
100	X	8,549
120	X	11,021

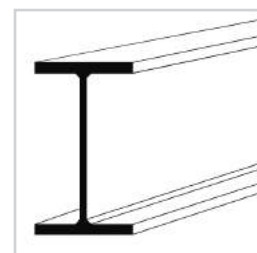

Wir erweitern ständig unser Lagerprogramm, nicht aufgeführte Abmessungen sind auf Anfrage lieferbar.

■ **WINKELSTAHL S235JR FEUERVERZINKT GLEICHSCH.**
EN10056/EN10025

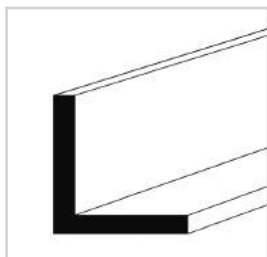

mm	mm	6 mtr	kg/mtr	mm	mm	6 mtr	kg/mtr
20	3	X	0,930	50	5	X	3,960
25	3	X	1,180	50	6	X	4,690
25	4	X	1,523	60	5	X	4,799
30	3	X	1,430	60	6	X	5,700
30	4	X	1,870	70	7	X	7,750
30	5	X	2,268	80	6	X	7,403
35	4	X	2,210	80	8	X	10,150
40	3	X	1,930	80	10	X	12,495
40	4	X	2,550	90	9	X	12,688
40	5	X	3,120	100	8	X	12,810
45	5	X	3,550	100	10	X	15,800
50	4	X	3,213	120	12	X	22,680

■ **WINKELSTAHL S235JR FEUERVERZINKT UNGLEICHSCH.**
EN10056/EN10025

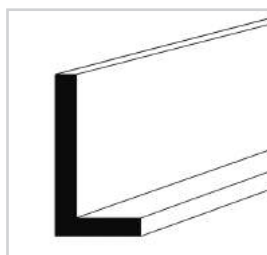

mm	mm	mm	6 mtr	kg/mtr	mm	mm	mm	6 mtr	kg/mtr
30	20	3	X	1,170	80	60	7	X	6,930
30	20	4	X	1,523	80	65	6	X	7,200
40	20	3	X	1,420	80	65	8	X	9,010
40	20	4	X	1,860	90	60	6	X	7,161
40	25	4	X	2,027	100	50	6	X	7,200
45	30	4	X	2,370	100	50	8	X	9,440
50	30	5	X	3,110	120	80	8	X	12,810
50	40	4	X	2,850	150	100	10	X	19,950
60	30	5	X	3,505	150	100	12	X	23,730
60	30	6	X	4,179	160	80	10	X	19,110
60	40	5	X	3,950	180	90	10	X	21,630
60	40	6	X	4,690	200	100	10	X	24,150
75	50	5	X	4,980	200	100	12	X	28,665
80	40	6	X	5,680	200	100	16	X	37,700

■ **BREITFLACHSTAHL S235JR FEUERVERZINKT**
EN10058/EN10025

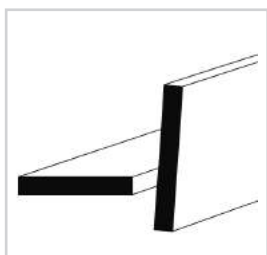

mm	mm	6 mtr	kg/mtr
200	5	X	8,400
200	6	X	10,080
200	8	X	13,440
200	10	X	16,800

Wir erweitern ständig unser Lagerprogramm, nicht aufgeführte Abmessungen sind auf Anfrage lieferbar.

FEINBLECH DC01 KALTGEWALZT
EN10131/EN10130

Stärke mm	1000 x 2000 mm kg/Tfl.	1250 x 2500 mm kg/Tfl.	1500 x 3000 mm kg/Tfl.
0,50	8,00		
0,63	10,08	15,75	
0,75	12,00	18,75	27,00
0,88	14,08	22,00	31,68
1,00	16,00	25,00	36,00
1,25	20,00	31,25	45,00
1,50	24,00	37,50	54,00
2,00	32,00	50,00	72,00
2,50	40,00	62,50	90,00
2,99	48,00	75,00	108,00

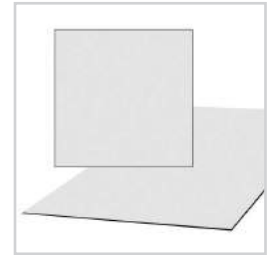

FEINBLECH DD11 GEBEIZT+GEFETTET
EN10111/EN10051

Stärke mm	1000 x 2000 mm kg/Tfl.	1250 x 2500 mm kg/Tfl.	1500 x 3000 mm kg/Tfl.
3,50	56,00		

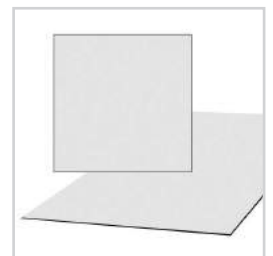

BLECH S235JR GEBEIZT+GEFETTET
EN10051/EN10029/EN10025

Stärke mm	1000 x 2000 mm kg/Tfl.	1250 x 2500 mm kg/Tfl.	1500 x 3000 mm kg/Tfl.
2,00	32,00	50,00	72,00
2,50	40,00	62,50	90,00
3,00	48,00	75,00	108,00
4,00	64,00	100,00	144,00
5,00	80,00	125,00	180,00
6,00	96,00	150,00	216,00
8,00	128,00	200,00	288,00
10,00	160,00	250,00	360,00
12,00	192,00	300,00	432,00
15,00	240,00	375,00	540,00
20,00	320,00	500,00	720,00
25,00	400,00	625,00	900,00

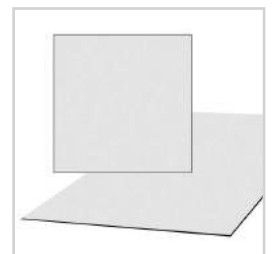

Wir erweitern ständig unser Lagerprogramm, nicht aufgeführte Abmessungen sind auf Anfrage lieferbar.

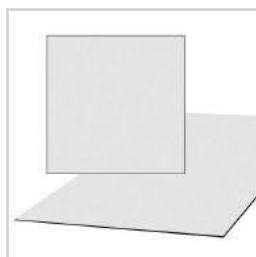

BANDBLECH S355MC GEBEIZT+GEFETTET
EN10051/EN10149-2

Stärke mm	1000 x 2000 mm kg/Tfl.	1250 x 2500 mm kg/Tfl.	1500 x 3000 mm kg/Tfl.
2,00	32,00	50,00	72,00
2,50	40,00	62,50	90,00
3,00	48,00	75,00	108,00
4,00	64,00	100,00	144,00
5,00	80,00	125,00	180,00
6,00	96,00	150,00	216,00
8,00	128,00	200,00	288,00
10,00	160,00	250,00	360,00
12,00	192,00	300,00	432,00
15,00	240,00	375,00	540,00
20,00	320,00	500,00	720,00

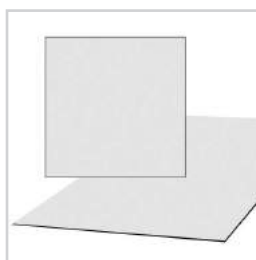

BAND- UND QUARTOUBLECH S235JR
EN10051/EN10029/EN10025

Stärke mm	1000 x 2000 mm kg/Tfl.	1250 x 2500 mm kg/Tfl.	1500 x 3000 mm kg/Tfl.	2000 x 6000 mm kg/Tfl.
3,00	48,00	75,00	108,00	288,00
4,00	64,00	100,00	144,00	384,00
5,00	80,00	125,00	180,00	480,00
6,00	96,00	150,00	216,00	576,00
8,00	128,00	200,00	288,00	768,00
10,00	160,00	250,00	360,00	960,00
12,00	192,00	300,00	432,00	1152,00
-	-	-	-	-
15,00	240,00	375,00	540,00	1440,00
20,00	320,00	500,00	720,00	1920,00
25,00	400,00	625,00	900,00	2400,00
30,00	480,00	750,00	1080,00	2880,00
35,00	560,00	875,00	1260,00	3360,00
40,00	640,00	1000,00	1440,00	3840,00
45,00	720,00	1125,00	1620,00	4320,00
50,00	800,00	1250,00	1800,00	4800,00
60,00	960,00	1500,00	2160,00	
80,00	1280,00			

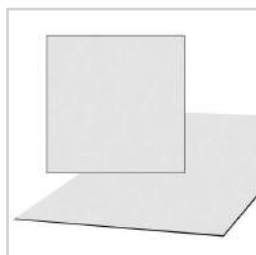

BANDBLECH S355MC SCHWARZ
EN10051/EN10149-2 KBZ: -20°

Stärke mm	1000 x 2000 mm kg/Tfl.	1250 x 2500 mm kg/Tfl.	1500 x 3000 mm kg/Tfl.	2000 x 6000 mm kg/Tfl.
8,00	128,00	200,00	288,00	
10,00	160,00	250,00	360,00	
12,00	192,00	300,00	432,00	

Wir erweitern ständig unser Lagerprogramm, nicht aufgeführte Abmessungen sind auf Anfrage lieferbar.

BAND- UND QUARTBLECH S355J2+N
EN10051/EN10029/EN10025

Stärke mm	1000 x 2000 mm kg/Tfl.	1250 x 2500 mm kg/Tfl.	1500 x 3000 mm kg/Tfl.	2000 x 6000 mm kg/Tfl.
8,00				768,00
10,00				960,00
12,00				1152,00
-	-	-	-	-
15,00	240,00	375,00	540,00	1440,00
20,00	320,00	500,00	720,00	1920,00
25,00	400,00	625,00	900,00	2400,00
30,00	480,00	750,00	1080,00	2880,00
35,00	560,00	875,00	1260,00	3360,00
40,00	640,00	1000,00	1440,00	3840,00
50,00	800,00	1250,00	1800,00	4800,00

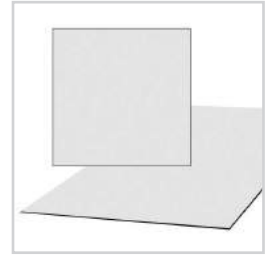

TRÄNENBLECH S235JR
DIN 59220/EN10025

Stärke mm	1000 x 2000 mm kg/Tfl.	1250 x 2500 mm kg/Tfl.	1500 x 3000 mm kg/Tfl.
3,00	52,00	82,00	117,00
4,00	68,00	107,00	153,00
5,00	84,00	132,00	189,00
6,00	102,00	160,00	230,00
8,00	134,00	210,00	302,00
10,00	166,00	260,00	374,00
12,00	198,00	309,00	446,00
15,00			567,00

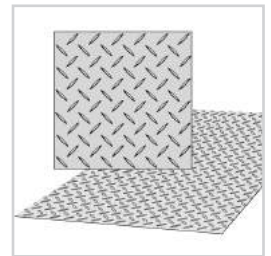

WETTERFESTES BLECH CORTEN-A (1.8946)
EN10131

Stärke mm	1000 x 2000 mm kg/Tfl.	1250 x 2500 mm kg/Tfl.	1500 x 3000 mm kg/Tfl.
2,00	32,00	50,00	72,00

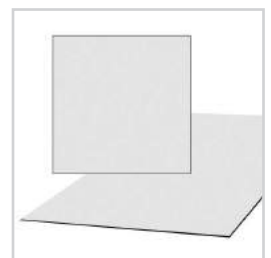

WETTERFESTES BLECH S355 J2W+N (1.8965)
EN10029/EN10025

Stärke mm	1000 x 2000 mm kg/Tfl.	1250 x 2500 mm kg/Tfl.	1500 x 3000 mm kg/Tfl.
3,00	48,00	75,00	108,00
4,00	64,00	100,00	144,00
5,00	80,00	125,00	180,00
6,00	96,00	150,00	216,00
8,00	128,00	200,00	288,00
10,00	160,00	250,00	360,00
12,00	192,00	300,00	432,00
15,00	240,00	375,00	540,00
20,00	320,00	500,00	720,00

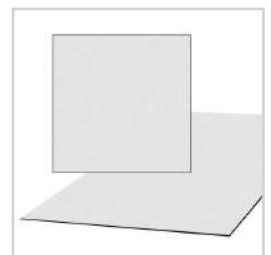

Wir erweitern ständig unser Lagerprogramm, nicht aufgeführte Abmessungen sind auf Anfrage lieferbar.

■ **SENDZIMIRVERZINKTES BLECH DX51D+Z275-MA-C**
EN10143/EN10346

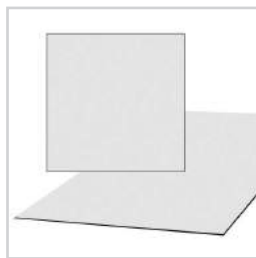

Stärke mm	1000 x 2000 mm kg/Tfl.	1250 x 2500 mm kg/Tfl.	1500 x 3000 mm kg/Tfl.	1500 x 4000 mm kg/Tfl.
0,50	8,00			
0,63	10,08	15,75	22,68	
0,75	12,00	18,75	27,00	
0,88	14,08	22,00	31,68	
1,00	16,00	25,00	36,00	
1,25	20,00	31,25	45,00	
1,50	24,00	37,50	54,00	
2,00	32,00	50,00	72,00	96,00
2,50	40,00	62,50	90,00	
2,99	48,00	75,00	108,00	144,00
4,00	64,00	100,00	144,00	
5,00	80,00	125,00	180,00	

■ **TITANZINKBLECH**

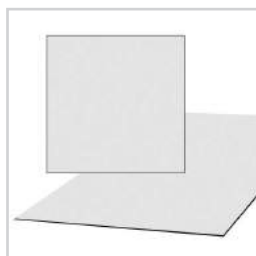

Stärke mm	1000 x 2000 mm kg/Tfl.
0,70	11,20

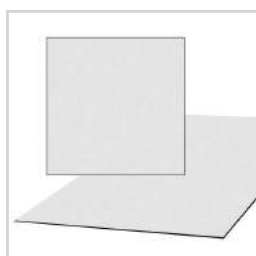

■ **ELEKTROLYTISCH VERZINKTES FEINBLECH DC 01 + ZE 25/25**
EN10131/EN10152

Stärke mm	1000 x 2000 mm kg/Tfl.	1250 x 2500 mm kg/Tfl.	1500 x 3000 mm kg/Tfl.
0,88	14,08	22,00	31,68
1,00	16,00	25,00	36,00
1,50	24,00	37,50	54,00
2,00	32,00	50,00	72,00
2,50	40,00		
2,99	48,00	75,00	108,00

Wir erweitern ständig unser Lagerprogramm, nicht aufgeführte Abmessungen sind auf Anfrage lieferbar.

■ VERSCHLEISSFESTES BLECH RAEX AR 400
EN10029

Stärke mm	1000 x 2000 mm kg/Tfl.	1250 x 2500 mm kg/Tfl.	1500 x 3000 mm kg/Tfl.
3,00			108,00
4,00	64,00	100,00	144,00
5,00	80,00	125,00	180,00
6,00	96,00	150,00	216,00
8,00	128,00	200,00	288,00
10,00	160,00	250,00	360,00
12,00	192,00	300,00	432,00
15,00	240,00	375,00	540,00
20,00	320,00	500,00	720,00
30,00			1080,00

**Einsatz-
möglichkeiten:**

Stahlhochbau
Brückenbau
Behälterbau
Waggonbau
Gerätebau
Abgasanlagen
Wasserbau

**Mechanische
Eigenschaften:**

Streckgrenze Rp0.2
min. 1000 N/mm²
Zugfestigkeit Rm
1250 N/mm²
Bruchdehnung A5
min. 10 %
Härte
360-420 HB
Kerbschlagarbeit
längs -40 °C
Av min. 40 J

**Chemische
Zusammensetzung:**

C ≤ 0.20
Si ≤ 0.70
Mn ≤ 1.70
P ≤ 0.030
S ≤ 0.015
Cr ≤ 1.00
Ni ≤ 0.40
B ≤ 0.004
Al ≤ 0.050

RAEX Warmgewalzte Stahlbleche und -bänder
Verschleiß- und oberflächendruckbeständige Stähle

Raex ist ein gehärteter verschleißfester Stahl, der für Beständigkeit gegen abrasiven Verschleiß und hohen Oberflächendruck konzipiert ist. Durch den Einsatz von Raex können die Laufzeiten von Maschinen erhöht und die Kosten für Verschleißkomponenten gesenkt werden. Dank der hohen Festigkeit kann Raex für Leichtbauprodukte mit eleganter Form und hoher Energieeffizienz eingesetzt werden. Raex erlaubt eine innovative und umweltschonende Produktentwicklung. Raex bietet in Relation zur hohen Festigkeit gute Umformeigenschaften. Die Verarbeitung darf nur unter Einhaltung entsprechender Vorkehrungen zur Arbeitssicherheit erfolgen.

Wir erweitern ständig unser Lagerprogramm, nicht aufgeführte Abmessungen sind auf Anfrage lieferbar.

■ **LOCHBLECH QG 3.0 - 5.0**

DIN 24041

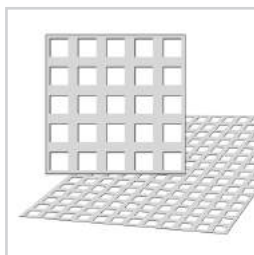

Material	1000 x 2000 mm Stärke in mm	1250 x 2500 mm Stärke in mm	1500 x 3000 mm Stärke in mm
Stahl	1,00		

■ **LOCHBLECH QG 5.0 - 8.0**

DIN 24041

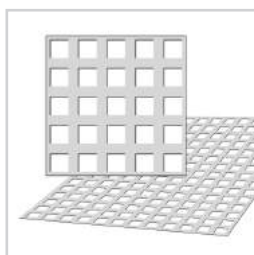

Material	1000 x 2000 mm Stärke in mm	1250 x 2500 mm Stärke in mm	1500 x 3000 mm Stärke in mm
Stahl	1,00		
Stahl	1,50	1,50	1,50
Stahl	2,00		
verzinkt	1,00		
verzinkt		1,50	
1.4301	1,50		
1.4301 eins. geschl. K240	1,50		
Aluminium	2,00		

■ **LOCHBLECH QG 8.0 - 10.0**

DIN 24041

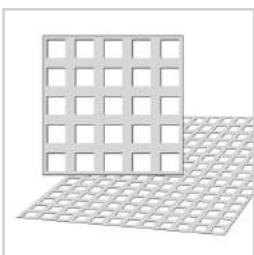

Material	1000 x 2000 mm Stärke in mm	1250 x 2500 mm Stärke in mm	1500 x 3000 mm Stärke in mm
Stahl	1,00		
Stahl	1,50		

■ **LOCHBLECH QG 8.0 - 12.0**

DIN 24041

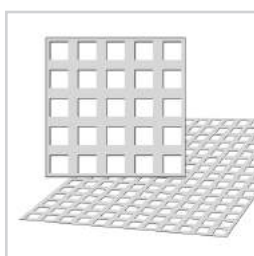

Material	1000 x 2000 mm Stärke in mm	1250 x 2500 mm Stärke in mm	1500 x 3000 mm Stärke in mm
Stahl	1,00		
Stahl	1,50	1,50	1,50
Stahl	2,00	2,00	2,00
verzinkt	1,00		
verzinkt		2,00	

■ **LOCHBLECH QG 10.0 - 12.0**

DIN 24041

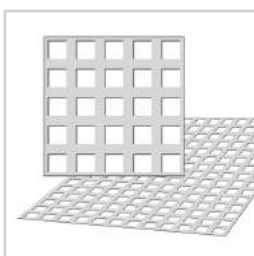

Material	1000 x 2000 mm Stärke in mm	1250 x 2500 mm Stärke in mm	1500 x 3000 mm Stärke in mm
Stahl	1,50		

Wir erweitern ständig unser Lagerprogramm, nicht aufgeführte Abmessungen sind auf Anfrage lieferbar.

LOCHBLECH QG 10.0 - 14.0
DIN 24041

Material	1000 x 2000 mm Stärke in mm	1250 x 2500 mm Stärke in mm	1500 x 3000 mm Stärke in mm
Stahl		2,00	
Aluminium		1,50	

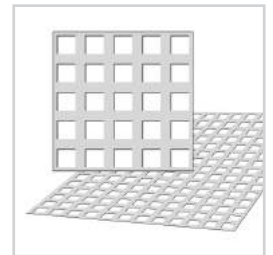

LOCHBLECH QG 10.0 - 15.0
DIN 24041

Material	1000 x 2000 mm Stärke in mm	1250 x 2500 mm Stärke in mm	1500 x 3000 mm Stärke in mm
Stahl	1,00		1,00
Stahl	1,50	1,50	1,50
Stahl	2,00	2,00	2,00
verzinkt	1,00		
verzinkt	1,50		1,50
verzinkt	2,00	2,00	
1.4301	1,00		
1.4301	1,50	1,50	
1.4301	2,00	2,00	
1.4301 eins. geschl. K240	1,50		
Aluminium	1,50		
Aluminium	2,00	2,00	

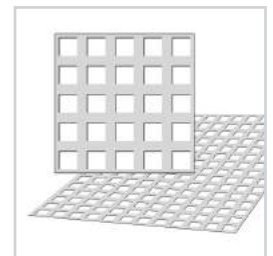

LOCHBLECH QG 10.0 - 30.0
DIN 24041

Material	1000 x 2000 mm Stärke in mm	1250 x 2500 mm Stärke in mm	1500 x 3000 mm Stärke in mm
Stahl	2,00		
Aluminium	2,00		

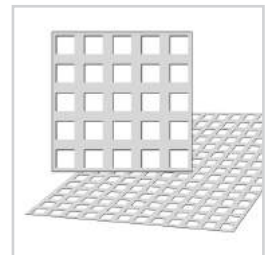

LOCHBLECH QG 15.0 - 20.0
DIN 24041

Material	1000 x 2000 mm Stärke in mm	1250 x 2500 mm Stärke in mm	1500 x 3000 mm Stärke in mm
Stahl	2,00	2,00	
Stahl	3,00		

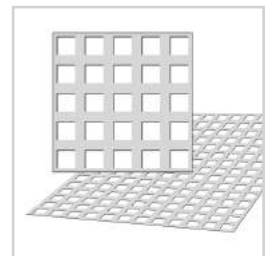

LOCHBLECH QG 15.0 - 40.0
DIN 24041

Material	1000 x 2000 mm Stärke in mm	1250 x 2500 mm Stärke in mm	1500 x 3000 mm Stärke in mm
1.4301	1,50		
Aluminium	2,00		

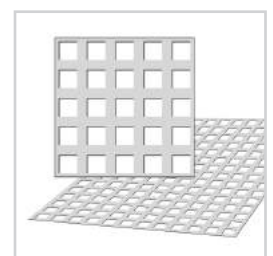

Wir erweitern ständig unser Lagerprogramm, nicht aufgeführte Abmessungen sind auf Anfrage lieferbar.

■ **LOCHBLECH QG 15.0 - 60.0**

DIN 24041

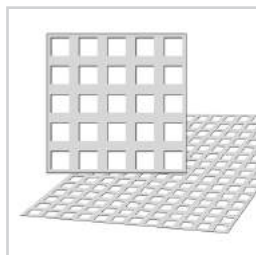

Material	1000 x 2000 mm Stärke in mm	1250 x 2500 mm Stärke in mm	1500 x 3000 mm Stärke in mm
Stahl		2,00	
Aluminium		2,00	

■ **LOCHBLECH QG 20.0 - 50.0**

DIN 24041

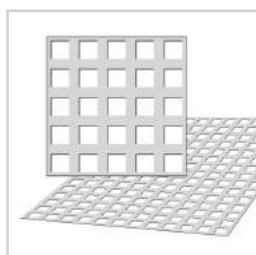

Material	1000 x 2000 mm Stärke in mm	1250 x 2500 mm Stärke in mm	1500 x 3000 mm Stärke in mm
1.4301	1,50		
Aluminium	2,00	2,00	

■ **LOCHBLECH QG 25.0 - 30.0**

DIN 24041

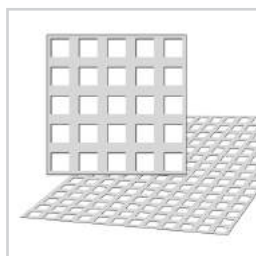

Material	1000 x 2000 mm Stärke in mm	1250 x 2500 mm Stärke in mm	1500 x 3000 mm Stärke in mm
Stahl	2,00		

■ **LOCHBLECH QG 25.0 - 70.0**

DIN 24041

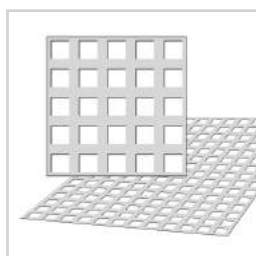

Material	1000 x 2000 mm Stärke in mm	1250 x 2500 mm Stärke in mm	1500 x 3000 mm Stärke in mm
Aluminium einseitig foliert		2,00	

■ **LOCHBLECH RG 4.5 X 15.0**

DIN 24041

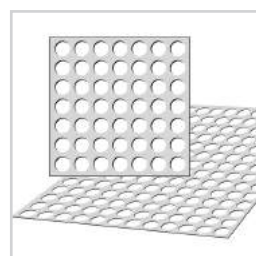

Material	1000 x 2000 mm Stärke in mm	1250 x 2500 mm Stärke in mm	1500 x 3000 mm Stärke in mm
Stahl	1,00		
Stahl	1,50		
verzinkt	1,50		
Aluminium	1,50		

Wir erweitern ständig unser Lagerprogramm, nicht aufgeführte Abmessungen sind auf Anfrage lieferbar.

LOCHBLECH RG 20.0 - 48.5
DIN 24041

Material	1000 x 2000 mm Stärke in mm	1250 x 2500 mm Stärke in mm	1500 x 3000 mm Stärke in mm
Stahl	2,00		
Aluminium	2,00		

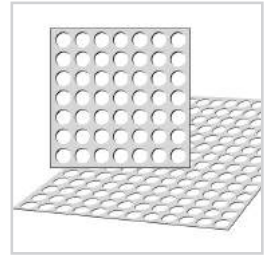

LOCHBLECH RV 1.5 - 2.5
DIN 24041

Material	1000 x 2000 mm Stärke in mm	1250 x 2500 mm Stärke in mm	1500 x 3000 mm Stärke in mm
Stahl	1,00		

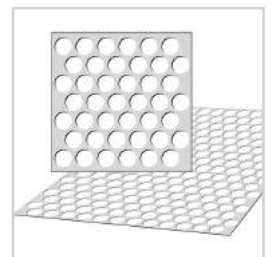

LOCHBLECH RV 2.0 - 3.5
DIN 24041

Material	1000 x 2000 mm Stärke in mm	1250 x 2500 mm Stärke in mm	1500 x 3000 mm Stärke in mm
Stahl	1,50		
Stahl	2,00		
1.4301	1,50	1,50	

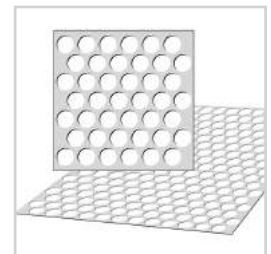

LOCHBLECH RV 3.0 - 5.0
DIN 24041

Material	1000 x 2000 mm Stärke in mm	1250 x 2500 mm Stärke in mm	1500 x 3000 mm Stärke in mm
Stahl	1,00	1,00	
Stahl	1,50	1,50	
verzinkt	1,00	1,00	
1.4301	1,00		
1.4301	1,50	1,50	
Aluminium	1,00		
Aluminium	1,50		

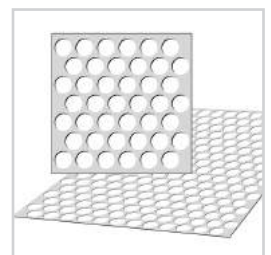

Wir erweitern ständig unser Lagerprogramm, nicht aufgeführte Abmessungen sind auf Anfrage lieferbar.

■ **LOCHBLECH RV 4.0 - 6.0**

DIN 24041

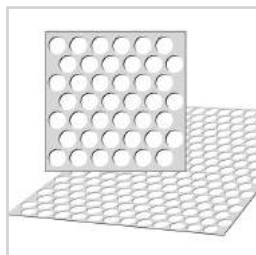

Material	1000 x 2000 mm Stärke in mm	1250 x 2500 mm Stärke in mm	1500 x 3000 mm Stärke in mm
Stahl	1,50		

■ **LOCHBLECH RV 5.0 - 8.0**

DIN 24041

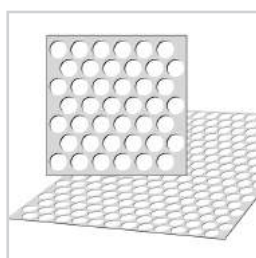

Material	1000 x 2000 mm Stärke in mm	1250 x 2500 mm Stärke in mm	1500 x 3000 mm Stärke in mm
Stahl	1,00		
Stahl	1,50	1,50	1,50
Stahl	2,00		2,00
Stahl	3,00	3,00	
verzinkt	1,00	1,00	1,00
verzinkt	1,50	1,50	1,50
verzinkt	2,00	2,00	
1.4301	1,00		
1.4301	1,50	1,50	
1.4301	2,00		
1.4301 eins. geschl. K240	1,50		
Aluminium	1,00		
Aluminium	2,00	2,00	
Aluminium	3,00		

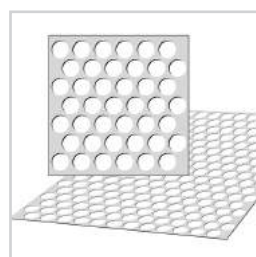

■ **LOCHBLECH RV 6.0 - 9.0**

DIN 24041

Material	1000 x 2000 mm Stärke in mm	1250 x 2500 mm Stärke in mm	1500 x 3000 mm Stärke in mm
Stahl	3,00		

■ **LOCHBLECH RV 8.0 - 12.0**

DIN 24041

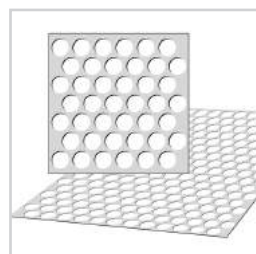

Material	1000 x 2000 mm Stärke in mm	1250 x 2500 mm Stärke in mm	1500 x 3000 mm Stärke in mm
Stahl	1,00		
Stahl	1,50	1,50	1,50
Stahl	2,00	2,00	
Stahl	4,00		
verzinkt	1,50		
1.4301	1,50		
Aluminium	2,00	2,00	

Wir erweitern ständig unser Lagerprogramm, nicht aufgeführte Abmessungen sind auf Anfrage lieferbar.

LOCHBLECH RV 10.0 - 15.0
DIN 24041

Material	1000 x 2000 mm Stärke in mm	1250 x 2500 mm Stärke in mm	1500 x 3000 mm Stärke in mm
Stahl	1,00		
Stahl	1,50	1,50	1,50
Stahl	2,00	2,00	2,00
Stahl	3,00		
verzinkt	1,50	1,50	1,50
verzinkt	2,00	2,00	
1.4301	1,00		
1.4301	1,50	1,50	
1.4301	2,00	2,00	
1.4301 eins. geschl. K240	1,50	1,50	
1.4301 beids.geschl. K240	1,50		
Aluminium	1,50		
Aluminium	2,00	2,00	

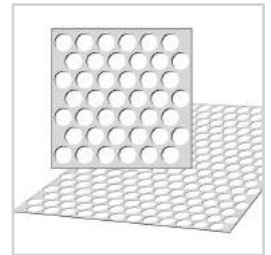

LOCHBLECH RV 12.0 - 16.0
DIN 24041

Material	1000 x 2000 mm Stärke in mm	1250 x 2500 mm Stärke in mm	1500 x 3000 mm Stärke in mm
Stahl	2,00		

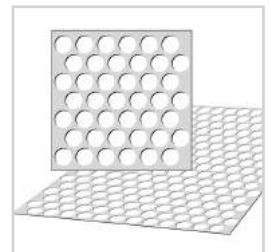

LOCHBLECH RV 15.0 - 20.0
DIN 24041

Material	1000 x 2000 mm Stärke in mm	1250 x 2500 mm Stärke in mm	1500 x 3000 mm Stärke in mm
Stahl	1,50		
Stahl	2,00	2,00	
Stahl	3,00		

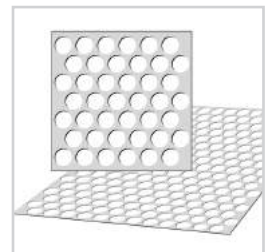

LOCHBLECH RV 15.0 - 21.0
DIN 24041

Material	1000 x 2000 mm Stärke in mm	1250 x 2500 mm Stärke in mm	1500 x 3000 mm Stärke in mm
Stahl			2,00
verzinkt		2,00	

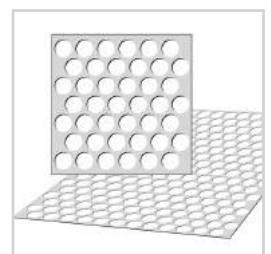

LOCHBLECH RV 20.0 - 28.0
DIN 24041

Material	1000 x 2000 mm Stärke in mm	1250 x 2500 mm Stärke in mm	1500 x 3000 mm Stärke in mm
Stahl	2,00		2,00
verzinkt	2,00	2,00	
Aluminium	2,00		

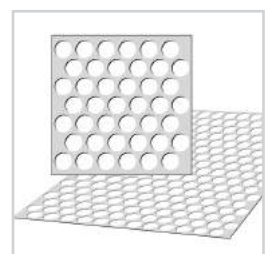

Wir erweitern ständig unser Lagerprogramm, nicht aufgeführte Abmessungen sind auf Anfrage lieferbar.

■ **EINFASSPROFIL T-PROFIL**

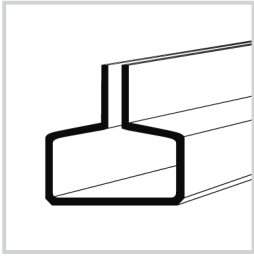

Material	Abmessung mm
Stahl	20 x 20 x 1,7
1.4301	20 x 20 x 1,7
verzinkt	20 x 20 x 1,7

■ **EINFASSPROFIL RUND**

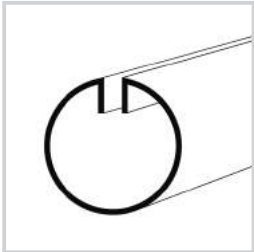

Material	Abmessung mm	Abmessung mm
Stahl	18 x 1,25	27 x 1,5
verzinkt	18 x 1,25	
1.4301	18 x 1,25	
1.4301 geschliffen K240	18 x 1,70	27 x 1,5

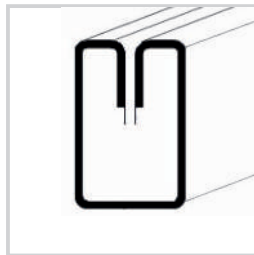

■ **EINFASSPROFIL RECHTECK**

Material	Abmessung mm
1.4301	30 x 20 x 1,7

■ **SKIZZE LOCHBLECHE**

LOCHWEITE, LOCHTEILUNG, STEG

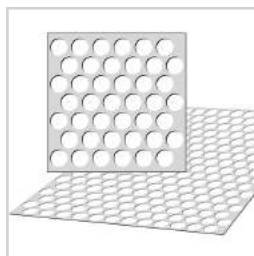

RV
Rundlochung in
versetzten Reihen

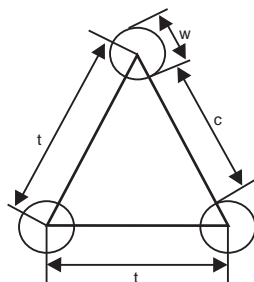

RG
Rundlochung in
geraden Reihen

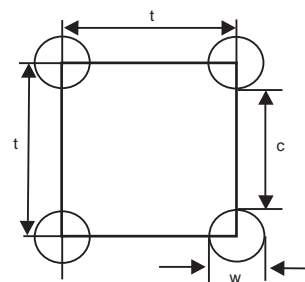

QG
Quadratlochung in
geraden Reihen

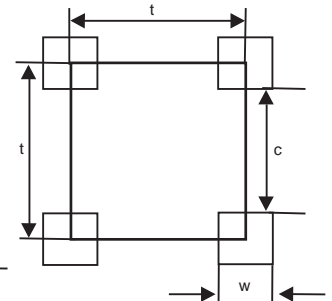

w = Lochweite t = Lochteilung c = Steg

Wir erweitern ständig unser Lagerprogramm, nicht aufgeführte Abmessungen sind auf Anfrage lieferbar.

■ QUADRATROHR E235, S1 / S235 JRH, SCHWARZ, 6M
EN10305-5/EN10219

mm	mm	mm	wb	kg/mtr	mm	mm	mm	wb	kg/mtr
15	15	1,5	X	0,630	45	45	3	X	3,800
15	15	2	X	0,810	45	45	4	X	4,880
20	20	1,5	X	0,870	50	50	2	X	3,010
20	20	2	X	1,120	50	50	2,5	X	3,720
20	20	2,5	X	1,330	50	50	3	X	4,280
20	20	3	X	1,600	50	50	4	X	5,510
25	25	1,5	X	1,100	50	50	5	X	6,560
25	25	2	X	1,440	55	55	2	X	3,320
25	25	2,5	X	1,760	55	55	3	X	4,750
25	25	3	X	1,920	55	55	4	X	6,140
30	30	1,5	X	1,340	60	60	2	X	3,640
30	30	2	X	1,750	60	60	2,5	X	4,500
30	30	2,5	X	2,150	60	60	3	X	5,220
30	30	3	X	2,390	60	60	4	X	6,760
30	30	4	X	3,320	60	60	5	X	8,130
34	34	2	X	2,000	70	70	2	X	4,260
34	34	3	X	2,770	70	70	3	X	6,160
35	35	1,5	X	1,570	70	70	4	X	8,020
35	35	2	X	2,070	70	70	5	X	9,700
35	35	2,5	X	2,540	80	80	2	X	4,890
35	35	3	X	2,860	80	80	3	X	7,100
35	35	4	X	3,790	80	80	4	X	9,280
40	40	1,5	X	1,810	80	80	5	X	11,300
40	40	2	X	2,380	90	90	3	X	8,040
40	40	2,5	X	2,930	90	90	4	X	10,500
40	40	3	X	3,330	90	90	5	X	12,800
40	40	4	X	4,250	100	100	2	X	6,150
40	40	5	X	5,320	100	100	3	X	8,990
45	45	1,5	X	2,050	100	100	4	X	11,800
45	45	2	X	2,690	100	100	5	X	14,400

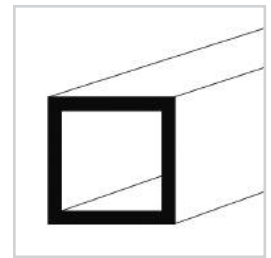

■ QUADRATROHR E235, S2 BLANK, 6M
EN10305-5/EN10025

mm	mm	mm	blk	kg/mtr	mm	mm	mm	blk	kg/mtr
10	10	1	X	0,280	30	30	3	X	2,390
10	10	1,5	X	0,400	35	35	1,5	X	1,570
12	12	1,5	X	0,490	35	35	2	X	2,070
15	15	1,5	X	0,630	40	40	1,5	X	1,810
15	15	2	X	0,810	40	40	2	X	2,380
16	16	1,5	X	0,670	40	40	2,5	X	2,930
18	18	1,5	X	0,770	40	40	3	X	3,330
20	20	1,5	X	0,870	40	40	4	X	4,250
20	20	2	X	1,120	45	45	1,5	X	2,050
20	20	2,5	X	1,330	45	45	2	X	2,690
25	25	1,5	X	1,100	50	50	1,5	X	2,270
25	25	2	X	1,440	50	50	2	X	3,010
25	25	2,5	X	1,760	50	50	3	X	4,280
25	25	3	X	1,920	55	55	2	X	3,320
30	30	1,5	X	1,340	60	60	2	X	3,640
30	30	2	X	1,750	60	60	3	X	5,220
30	30	2,5	X	2,150					

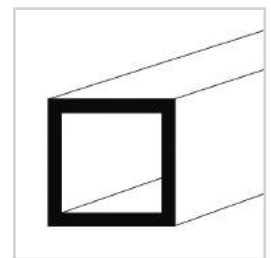

Wir erweitern ständig unser Lagerprogramm, nicht aufgeführte Abmessungen sind auf Anfrage lieferbar.

RECHTECKROHR E235, S1 / S235 JRH, SCHWARZ, 6M
EN10305-5/EN10219

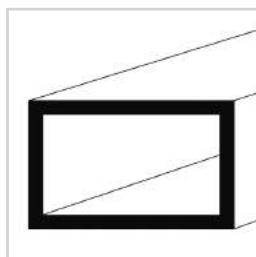

mm	mm	mm	wb	kg/mtr	mm	mm	mm	wb	kg/mtr
20	10	2	X	0,810	60	40	2	X	3,010
20	15	2	X	0,970	60	40	2,5	X	3,720
25	10	2	X	0,970	60	40	3	X	4,280
25	15	2	X	1,120	60	40	4	X	5,510
25	20	2	X	1,280	60	40	5	X	6,560
30	10	1,5	X	0,870	60	50	2	X	3,320
30	10	2	X	1,120	60	50	3	X	4,750
30	15	1,5	X	0,990	60	50	4	X	6,140
30	15	2	X	1,280	60	50	5	X	7,860
30	20	1,5	X	1,100	70	20	2	X	2,690
30	20	2	X	1,440	70	30	2	X	3,010
30	20	3	X	1,920	70	30	4	X	5,510
30	25	2	X	1,590	70	40	2	X	3,320
35	10	1,5	X	0,990	70	40	3	X	4,750
35	20	1,5	X	1,220	70	40	4	X	6,140
35	20	2	X	1,590	70	40	5	X	7,340
35	25	2	X	1,750	70	50	2	X	3,640
40	10	1,5	X	1,100	70	50	3	X	5,220
40	15	2	X	1,590	70	50	4	X	6,760
40	20	1,5	X	1,340	70	50	5	X	7,130
40	20	2	X	1,750	80	20	2	X	3,010
40	20	2,5	X	2,150	80	20	3	X	4,280
40	20	3	X	2,390	80	30	2	X	3,320
40	20	4	X	3,768	80	30	3	X	4,750
40	25	2	X	1,910	80	40	2	X	3,640
40	25	3	X	2,630	80	40	3	X	5,220
40	30	1,5	X	1,570	80	40	4	X	6,760
40	30	2	X	2,070	80	40	5	X	8,130
40	30	2,5	X	2,540	80	50	2	X	3,950
40	30	3	X	2,860	80	50	3	X	5,690
45	20	2	X	1,910	80	50	4	X	7,390
45	25	2	X	2,070	80	50	5	X	8,910
45	30	2	X	2,220	80	60	2	X	4,260
50	10	1,5	X	1,340	80	60	3	X	6,160
50	15	1,5	X	1,460	80	60	4	X	8,020
50	20	2	X	2,070	80	60	5	X	9,700
50	20	3	X	2,860	90	30	3	X	5,190
50	25	2	X	2,220	90	40	3	X	5,690
50	25	3	X	3,100	90	40	4	X	7,390
50	30	1,5	X	1,810	90	40	5	X	8,910
50	30	2	X	2,380	90	50	3	X	6,160
50	30	2,5	X	2,930	90	50	4	X	8,020
50	30	3	X	3,330	90	50	5	X	9,700
50	30	4	X	4,250	90	60	3	X	6,800
50	34	2	X	2,510	90	60	4	X	8,650
50	40	2	X	2,690	90	70	4	X	9,280
50	40	3	X	3,800	90	70	5	X	11,300
50	40	4	X	4,880	100	20	2	X	3,640
55	34	2	X	2,660	100	20	3	X	5,220
60	15	1,5	X	1,690	100	30	2	X	3,950
60	20	2	X	2,380	100	30	3	X	5,690
60	20	3	X	3,330	100	30	4	X	7,390
60	25	2	X	2,540	100	40	2	X	4,260
60	30	2	X	2,690	100	40	3	X	6,160
60	30	3	X	3,800	100	40	4	X	8,020
60	30	4	X	4,880	100	40	5	X	9,700

Wir erweitern ständig unser Lagerprogramm, nicht aufgeführte Abmessungen sind auf Anfrage lieferbar.

RECHTECKROHR E235, S1 / S235 JRH, SCHWARZ, 6M
 EN10305-5/EN10219

mm	mm	mm	wb	kg/mtr
100	50	2	X	4,580
100	50	3	X	6,630
100	50	4	X	8,650
100	50	5	X	10,500
100	60	2	X	4,890
100	60	3	X	7,100
100	60	4	X	9,280
100	60	5	X	11,300
100	80	2	X	5,526
100	80	3	X	8,040
100	80	4	X	10,500
100	80	5	X	12,800
120	30	2	X	4,480
120	30	3	X	6,630
120	40	2	X	4,890

mm	mm	mm	wb	kg/mtr
120	40	3	X	7,100
120	40	4	X	9,280
120	40	5	X	11,300
120	50	3	X	7,540
120	50	4	X	9,850
120	50	5	X	11,890
120	60	2	X	6,860
120	60	3	X	8,040
120	60	4	X	10,500
120	60	5	X	12,800
120	80	3	X	8,990
120	80	4	X	11,800
120	80	5	X	14,400
150	40	3	X	8,730

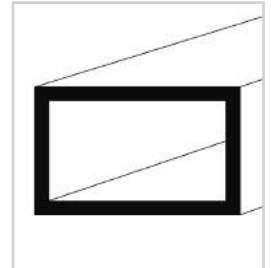

Wir erweitern ständig unser Lagerprogramm, nicht aufgeführte Abmessungen sind auf Anfrage lieferbar.

RECHTECKROHR E235, S2 BLANK, 6M
EN10305-5/EN10025

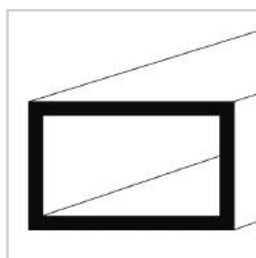

mm	mm	mm	blk	kg/mtr	mm	mm	mm	blk	kg/mtr
20	10	1,5	X	0,630	40	30	3	X	2,860
20	10	2	X	0,810	45	20	1,5	X	1,460
20	15	1,5	X	0,750	45	20	2	X	1,910
25	10	1,5	X	0,750	45	25	1,5	X	1,570
25	10	2	X	0,970	45	25	2	X	2,070
25	15	1,5	X	0,870	50	10	1,5	X	1,340
25	15	2	X	1,120	50	15	1,5	X	1,460
25	20	2	X	1,280	50	20	2	X	2,070
30	10	1,5	X	0,870	50	25	1,5	X	1,690
30	15	1,5	X	0,990	50	25	2	X	2,220
30	15	2	X	1,280	50	30	2	X	2,380
30	20	1,5	X	1,100	50	30	2,5	X	2,930
30	20	2	X	1,440	50	30	3	X	3,330
30	20	2,5	X	1,760	50	34	2	X	2,510
30	20	3	X	1,920	50	40	2	X	2,690
30	25	1,5	X	1,220	55	34	2	X	2,660
30	25	2	X	1,590	60	20	1,5	X	1,810
35	10	1,5	X	0,990	60	20	2	X	2,380
35	15	2	X	1,440	60	25	2	X	2,540
35	20	2	X	1,590	60	30	2	X	2,690
35	25	1,5	X	1,340	60	30	2,5	X	3,330
35	25	2	X	1,750	60	30	3	X	3,800
40	10	1,5	X	1,100	60	40	2	X	3,010
40	15	1,5	X	1,220	60	40	2,5	X	3,720
40	15	2	X	1,590	60	40	3	X	4,280
40	20	1,5	X	1,340	70	40	2	X	3,320
40	20	2	X	1,750	80	30	2	X	3,320
40	20	3	X	2,390	80	40	2	X	3,640
40	25	1,5	X	1,460	80	40	3	X	5,220
40	25	2	X	1,910	80	40	4	X	6,760
40	30	1,5	X	1,570	80	60	2	X	4,260
40	30	2	X	2,070	100	30	2	X	3,950
40	30	2,5	X	2,540	100	50	3	X	6,630

PROFILROHR MÖBELBAU E235, BLANK, 6M
EN10305-5/EN10025 mit einer runden Kante R6

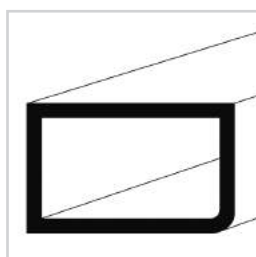

mm	mm	mm	blk	kg/mtr
30	28	2	X	1,700
30	30	2	X	1,750

Wir erweitern ständig unser Lagerprogramm, nicht aufgeführte Abmessungen sind auf Anfrage lieferbar.

■ QUADRATROHR E235 / S235JRH VERZINKT, 6M
 EN10305-5/EN10219

mm	mm	mm	kg/mtr	mm	mm	mm	kg/mtr
15	15	1,5	0,700	60	60	2	3,930
15	15	2	0,890	60	60	3	5,640
20	20	2	1,220	60	60	4	7,310
25	25	1,5	1,220	60	60	5	8,900
25	25	2	1,560	70	70	3	6,630
30	30	1,5	1,470	70	70	4	8,660
30	30	2	1,900	70	70	5	10,480
30	30	3	2,670	80	80	2	5,290
30	30	4	3,400	80	80	3	7,610
34	34	2	2,100	80	80	4	9,700
35	35	2	2,240	80	80	5	12,130
40	40	2	2,580	90	90	4	11,230
40	40	3	3,660	100	100	2	6,770
40	40	4	4,700	100	100	3	9,600
45	45	2	2,920	100	100	4	12,540
45	45	3	4,160	100	100	5	15,370
50	50	2	3,250	120	120	3	11,124
50	50	3	4,650	120	120	4	14,680
50	50	4	5,510	120	120	5	18,076

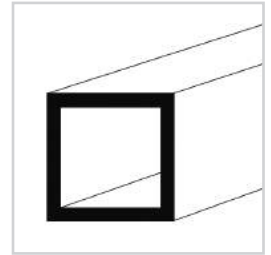

Wir erweitern ständig unser Lagerprogramm, nicht aufgeführte Abmessungen sind auf Anfrage lieferbar.

■ **RECHTECKROHR E235 / S235JRH VERZINKT, 6M**
EN10305-5 / EN10219

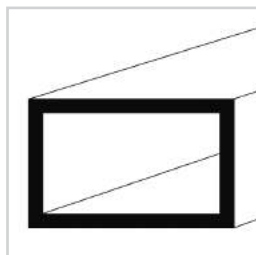

mm	mm	mm	kg/mtr	mm	mm	mm	kg/mtr
20	15	1,5	0,830	80	40	2	3,930
20	15	2	1,050	80	40	3	5,640
30	10	1,5	0,960	80	40	4	7,310
30	15	2	1,390	80	40	5	8,900
30	20	1,5	1,220	80	50	2	4,280
30	20	2	1,560	80	50	3	6,130
30	20	3	2,173	80	50	4	7,970
30	25	2	1,730	80	50	5	9,700
35	15	2	1,560	80	60	2	4,610
40	15	2	1,730	80	60	3	6,630
40	20	2	1,900	80	60	4	8,620
40	20	3	2,670	90	50	3	6,630
40	25	2	2,070	100	20	2	3,930
40	30	2	2,240	100	20	3	5,640
40	30	3	3,160	100	30	2	4,350
45	25	2	2,240	100	30	3	6,130
50	20	2	2,070	100	40	2	4,610
50	20	3	3,160	100	40	3	6,630
50	25	2	2,410	100	40	4	8,620
50	30	2	2,580	100	50	2	4,950
50	30	3	3,660	100	50	3	7,120
50	30	4	4,700	100	50	4	9,280
50	40	2	2,920	100	60	3	7,610
50	40	3	4,160	100	60	4	9,930
55	34	2	2,880	100	60	5	12,130
60	20	2	2,580	100	80	3	8,610
60	30	2	2,920	100	80	4	11,340
60	30	3	4,160	120	30	2	4,770
60	40	2	3,250	120	40	2	5,050
60	40	3	4,650	120	40	3	7,610
60	40	4	6,010	120	50	3	7,920
60	40	5	7,280	120	50	4	12,130
60	50	2	3,600	120	50	5	12,840
70	30	2	3,250	120	60	2	5,960
70	40	3	5,150	120	60	3	8,610
70	50	2	3,930	120	60	4	11,340
70	50	3	5,640	120	80	3	9,600
80	20	2	3,250	120	80	4	12,540
80	30	2	3,590	140	40	3	8,010
80	30	3	5,150	150	50	3	9,600

Wir erweitern ständig unser Lagerprogramm, nicht aufgeführte Abmessungen sind auf Anfrage lieferbar.

STAHLBAUHOHLPROFIL, KALTGEFERTIGT, HL 12M
EN10219/EN10025 MIT QUADRATISCHEM QUERSCHNITT

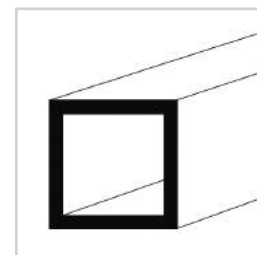

mm	mm	mm	S235JRH	S355J2H	kg/mtr	mm	mm	mm	S235JRH	S355J2H	kg/mtr
30	30	3		X	2,390	140	140	3,0	X		12,700
40	40	2,0	X		2,380	140	140	4,0	X		16,800
40	40	3,0	X	X	3,300	140	140	5,0	X	X	20,700
40	40	4,0	X	X	4,200	140	140	6,0	X	X	24,500
40	40	5,0	X		4,990	140	140	8,0		X	31,400
50	50	3,0	X	X	4,250	140	140	10,0		X	38,100
50	50	4,0	X	X	5,450	140	140	12,0		X	43,400
50	50	5,0	X	X	6,560	140	140	12,5		X	44,800
50	50	6,0	X	X	7,560	150	150	3,0	X		13,700
50	50	8,0		X	8,830	150	150	4,0	X		18,000
60	60	2,0	X		3,640	150	150	5,0	X	X	22,300
60	60	3,0	X	X	5,190	150	150	6,0	X	X	26,400
60	60	4,0	X	X	6,710	150	150	8,0		X	33,900
60	60	5,0	X	X	8,130	150	150	10,0		X	41,300
60	60	6,0	X	X	9,450	150	150	12,0		X	47,100
60	60	8,0		X	11,300	150	150	12,5		X	48,700
70	70	3,0	X		6,130	160	160	3,0	X		14,600
70	70	4,0	X		7,970	160	160	4,0	X		19,300
70	70	5,0	X	X	9,700	160	160	5,0	X		23,800
70	70	6,0	X	X	11,300	160	160	6,0	X		28,300
70	70	8,0		X	13,800	160	160	8,0		X	36,500
80	80	3,0	X	X	7,070	160	160	10,0		X	44,400
80	80	4,0	X	X	9,220	160	160	12,0		X	50,900
80	80	5,0	X	X	11,300	180	180	5,0	X	X	27,000
80	80	6,0	X	X	13,200	180	180	6,0	X	X	32,100
80	80	7,1		X	14,900	180	180	8,0		X	41,500
80	80	8,0		X	16,400	180	180	10,0		X	50,700
80	80	10,0		X	19,300	180	180	12,0		X	58,500
90	90	3,0	X		8,010	180	180	14,2		X	67,120
90	90	4,0	X		10,500	200	200	4,0	X		24,300
90	90	5,0	X	X	12,800	200	200	5,0	X		30,100
90	90	6,0	X	X	15,100	200	200	6,0	X		35,800
90	90	8,0		X	18,900	200	200	8,0		X	46,500
100	100	3,0	X	X	8,960	200	200	10,0		X	57,000
100	100	4,0	X	X	11,700	200	200	12,0		X	66,000
100	100	5,0	X	X	14,400	200	200	12,5		X	68,300
100	100	6,0	X	X	17,000	220	220	6,0	X		39,600
100	100	8,0		X	21,400	220	220	8,0		X	51,500
100	100	10,0		X	25,600	220	220	10,0		X	63,200
100	100	12,5		X	33,000	250	250	6,0	X		45,200
110	110	4,0	X		13,000	250	250	8,0		X	59,100
110	110	5,0	X		16,000	250	250	10,0		X	72,700
110	110	6,0	X		18,900	250	250	12,0		X	84,800
110	110	8,0		X	23,900	250	250	12,5		X	88,000
110	110	10,0		X	28,700	260	260	6,0	X		47,100
120	120	3,0	X		10,800	260	260	8,0		X	61,600
120	120	4,0	X	X	14,200	260	260	10,0		X	75,800
120	120	5,0	X	X	17,500	300	300	6,0	X		54,700
120	120	6,0	X	X	20,700	300	300	8,0		X	71,600
120	120	8,0		X	26,400	300	300	10,0		X	88,400
120	120	10,0		X	31,800	300	300	12,0		X	104,000
120	120	12,0		X	35,800	300	300	12,5		X	108,000
120	120	12,5		X	36,900	350	350	10,0		X	104,000
125	125	6,0	X		21,700	400	400	10,0		X	122,000

Wir erweitern ständig unser Lagerprogramm, nicht aufgeführte Abmessungen sind auf Anfrage lieferbar.

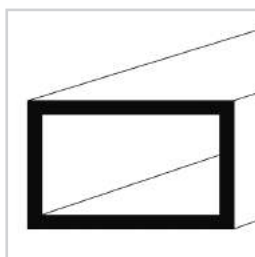

STAHLBAUHOHLPROFIL, KALTGEFERTIGT, HL 12M
EN10219/EN10025 MIT RECHTECKIGEM QUERSCHNITT

mm	mm	mm	S235JRH	S355J2H	kg/mtr	mm	mm	mm	S235JRH	S355J2H	kg/mtr
50	30	3,0	X	X	3,300	120	80	6,0	X	X	17,000
60	30	3,0		X	3,800	120	80	8,0		X	21,400
60	40	2,0	X		3,010	120	80	10,0		X	25,600
60	40	3,0	X	X	4,250	120	100	4,0	X		13,000
60	40	4,0	X		5,450	120	100	5,0	X		16,000
60	40	5,0	X		6,560	120	100	6,0	X		18,900
60	40	6,0		X	7,560	120	100	8,0		X	23,900
70	40	3,0		X	4,750	120	100	10,0		X	28,700
70	40	4,0	X	X	6,080	140	40	3,0	X		8,010
70	40	5,0	X		7,340	140	40	4,0	X		10,480
80	40	3,0	X	X	5,190	140	40	5,0	X		12,670
80	40	4,0	X	X	6,710	140	60	3,0	X		8,960
80	40	5,0	X	X	8,130	140	60	4,0	X		11,700
80	40	6,0	X	X	9,450	140	60	5,0	X		14,400
80	50	3,0	X		5,690	140	60	6,0	X	X	17,000
80	50	4,0	X		7,340	140	60	8,0		X	21,400
80	50	5,0	X		8,910	140	70	3,0	X		9,430
80	60	3,0	X	X	6,130	140	70	4,0	X		12,400
80	60	4,0	X		7,970	140	70	5,0	X		15,000
80	60	5,0	X	X	9,700	140	70	6,0	X		17,700
80	60	6,0	X	X	11,300	140	70	6,3		X	18,500
80	60	8,0		X	13,800	140	70	8,0		X	22,600
90	50	3,0	X		6,130	140	70	10,0		X	27,800
90	50	4,0	X		7,970	140	80	3,0	X		9,900
90	50	6,0	X		11,300	140	80	4,0	X	X	13,000
100	40	3,0	X		6,130	140	80	5,0	X	X	16,000
100	40	4,0	X		7,970	140	80	6,0	X	X	18,900
100	50	3,0	X	X	6,600	140	80	8,0		X	23,900
100	50	4,0	X	X	8,590	140	80	10,0		X	28,000
100	50	5,0	X	X	10,500	150	40	4,0	X		11,110
100	50	6,0	X	X	12,270	150	50	3,0	X		8,960
100	50	8,0		X	15,400	150	50	4,0	X		11,700
100	50	10,0		X	17,700	150	50	5,0	X		14,400
100	60	3,0	X		7,070	150	75	5,0	X		16,880
100	60	4,0	X		9,220	150	75	6,0	X		19,340
100	60	5,0	X	X	11,300	150	100	3,0	X		11,300
100	60	6,0	X	X	13,200	150	100	4,0	X		14,900
100	60	8,0		X	16,400	150	100	5,0	X		18,300
100	80	3,0	X		8,010	150	100	6,0	X	X	21,700
100	80	4,0	X		10,500	150	100	8,0		X	27,700
100	80	5,0	X		12,800	150	100	10,0		X	33,400
100	80	6,0	X	X	15,100	150	100	12,0		X	37,700
100	80	8,0		X	18,900	160	60	4,0	X		13,000
110	70	4,0	X		10,500	160	60	5,0	X		16,000
110	70	5,0	X		12,800	160	80	3,0	X		10,800
120	40	3,0	X		7,070	160	80	4,0	X		14,200
120	40	4,0	X		9,220	160	80	5,0	X		17,500
120	40	5,0	X		11,300	160	80	6,0	X	X	20,700
120	50	5,0	X		12,100	160	80	8,0		X	26,400
120	60	3,0	X	X	8,010	160	80	10,0		X	31,800
120	60	4,0	X	X	10,500	160	90	4,0	X		14,900
120	60	5,0	X	X	12,800	160	90	5,0	X		18,300
120	60	6,0	X	X	15,100	160	90	6,0	X		21,700
120	60	8,0		X	18,900	160	90	7,1		X	24,900
120	80	3,0	X		8,960	160	90	8,0		X	27,700
120	80	4,0	X	X	11,700						
120	80	5,0	X	X	14,400						



Wir erweitern ständig unser Lagerprogramm, nicht aufgeführte Abmessungen sind auf Anfrage lieferbar.

STAHLBAUHOHLPROFIL, KALTGEFERTIGT, HL 12M
EN10219/EN10025 MIT RECHTECKIGEM QUERSCHNITT

mm	mm	mm	S235JRH	S355J2H	kg/mtr
160	90	10,0		X	33,400
160	120	4,0		X	16,800
160	120	6,0	X		24,500
160	120	8,0		X	31,400
180	60	4,0	X		14,200
180	60	5,0	X		17,500
180	80	3,0	X		11,800
180	80	4,0	X		15,500
180	80	5,0	X		19,100
180	80	6,0	X	X	22,600
180	80	8,0		X	28,900
180	80	10,0		X	35,000
180	100	4,0	X		16,800
180	100	5,0	X	X	20,700
180	100	6,0	X	X	24,500
180	100	8,0		X	31,400
180	100	10,0		X	38,100
180	100	12,5		X	44,800
180	120	4,0	X		18,000
180	120	6,0	X	X	26,400
180	120	8,0		X	33,900
200	40	3,0	X		10,770
200	40	4,0	X		14,300
200	80	3,0	X		12,700
200	80	4,0	X		16,800
200	80	5,0	X		20,700
200	80	6,0	X		24,500
200	80	8,0		X	31,400
200	80	10,0		X	38,100
200	100	3,0	X		13,700
200	100	4,0	X		18,000
200	100	5,0	X		22,300
200	100	6,0	X	X	26,400
200	100	8,0		X	33,900
200	100	10,0		X	41,300
200	100	12,0		X	47,100
200	100	12,5		X	48,700
200	120	4,0	X		19,300
200	120	5,0	X		23,800
200	120	6,0	X	X	28,300
200	120	8,0		X	36,500
200	120	10,0		X	44,400
200	120	12,0		X	50,900
200	150	4,0	X		21,200

mm	mm	mm	S235JRH	S355J2H	kg/mtr
200	150	5,0	X		26,200
200	150	6,0	X	X	31,100
200	150	8,0		X	40,200
200	150	10,0		X	49,110
200	150	12,0		X	56,600
220	120	6,0	X	X	29,930
220	120	8,0		X	38,970
220	120	10,0		X	46,860
250	100	4,0	X		21,200
250	100	5,0	X		26,020
250	100	6,0	X	X	31,100
250	100	8,0		X	40,200
250	100	10,0		X	49,100
250	150	4,0	X		24,300
250	150	5,0	X		30,100
250	150	6,0	X		35,800
250	150	8,0		X	46,500
250	150	10,0		X	57,000
250	150	12,0		X	66,000
250	150	12,5		X	68,300
260	140	6,0	X		35,800
260	140	8,0		X	46,500
260	140	10,0		X	57,000
260	180	6,0	X	X	39,600
260	180	8,0		X	51,500
260	180	10,0		X	63,200
300	100	5,0	X	X	30,100
300	100	6,0	X		35,800
300	100	8,0		X	46,500
300	100	10,0		X	57,000
300	150	5,0		X	106,00
300	150	6,0	X		40,500
300	150	8,0		X	52,800
300	150	10,0		X	64,800
300	200	6,0	X		45,200
300	200	8,0		X	59,100
300	200	10,0		X	72,700
300	200	12,0		X	84,800
300	200	12,5		X	88,000
400	200	6,0	X		54,700
400	200	8,0		X	71,600
400	200	10,0		X	88,400
500	300	10,0		X	122,000

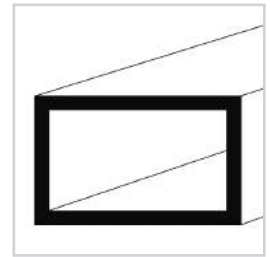

Wir erweitern ständig unser Lagerprogramm, nicht aufgeführte Abmessungen sind auf Anfrage lieferbar.

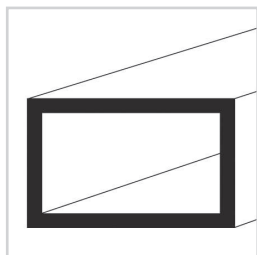

STAHLBAUHOHLPROFIL, KALTGEFERTIGT, HL 14 M
EN10219/EN10025 MIT RECHTECKIGEM / QUADRATISCEM QUERSCHNITT

mm	mm	mm	S235JRH	S355J2H	kg/mtr
140	140	6,0	X		24,500
160	80	4,0	X		14,200
200	100	6,0	X		26,400

mm	mm	mm	S235JRH	S355J2H	kg/mtr
200	100	8,0		X	33,900
300	150	6,0	X		40,500
300	150	8,0		X	52,800

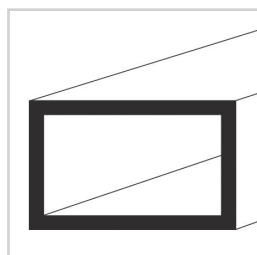

STAHLBAUHOHLPROFIL, WARMGEFERTIGT, HL 12 M
EN10210-2 MIT RECHTECKIGEM / QUADRATISCEM QUERSCHNITT

mm	mm	mm	S355J2H	kg/mtr
60	60	8,0	X	12,500
80	40	8,0	X	12,500
80	60	8,0	X	15,000
80	80	4,0	X	9,410
100	50	8,0	X	16,300
100	50	10,0	X	19,600

mm	mm	mm	S355J2H	kg/mtr
120	80	6,3	X	18,200
120	120	5,6	X	19,900
140	70	8,8	X	25,900
140	70	10,0	X	29,000
200	150	12,5	X	62,500
450	250	10	X	106,00

Wir erweitern ständig unser Lagerprogramm, nicht aufgeführte Abmessungen sind auf Anfrage lieferbar.

■ SCHNITTSCHEMATATA STAHLBAUHOHLPROFILE

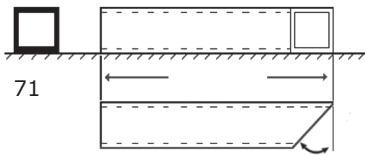

71

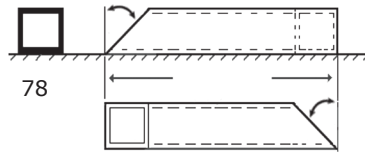

78

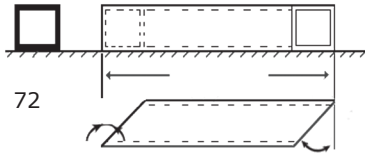

72

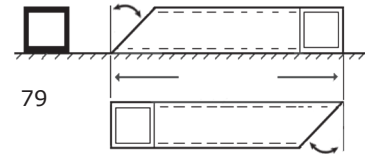

79

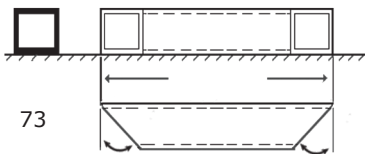

73

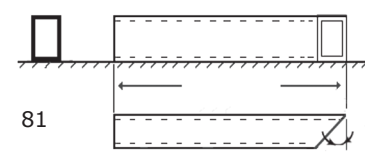

81

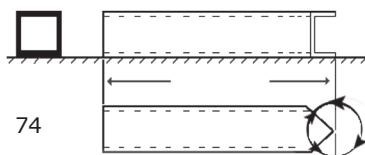

74

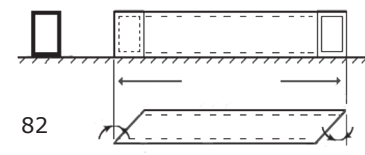

82

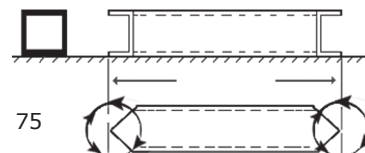

75

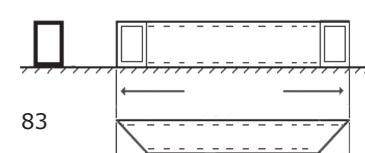

83

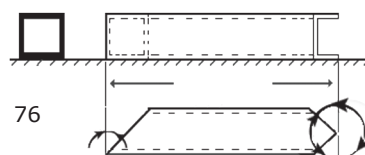

76

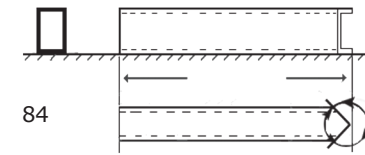

84

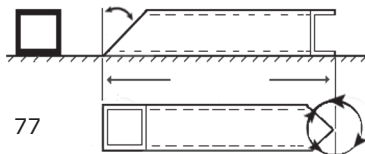

77

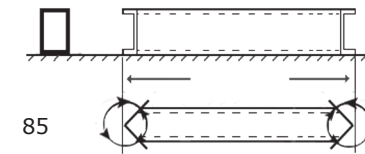

85

Schnittschemata
Gehrungsschnitte bis max. 60°
Bitte geben Sie die Nummer
des gewünschten Schnittsche-
mas bei Ihrer Bestellung an.

■ SCHNITTSCHEMATA STAHLBAUHOHLPROFILE

Schnittschemata
Gehrungsschnitte bis max. 60°
Bitte geben Sie die Nummer
des gewünschten Schnittsche-
mas bei Ihrer Bestellung an.

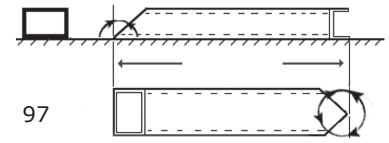
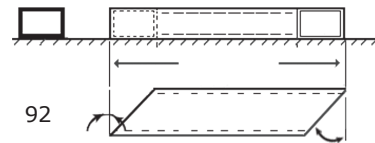
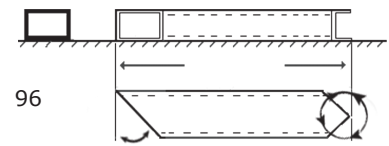
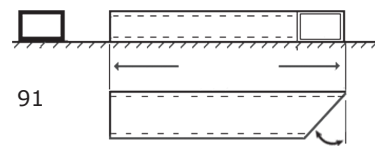
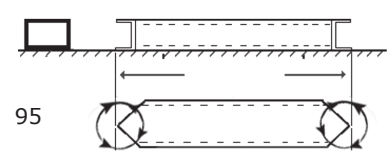
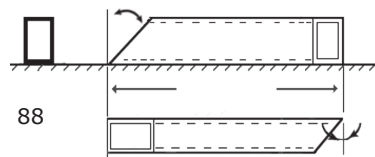
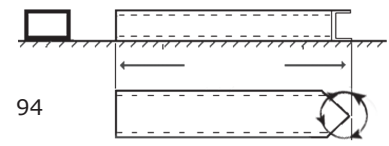
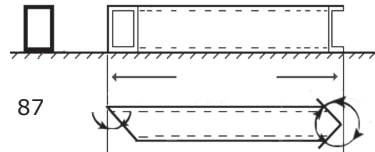
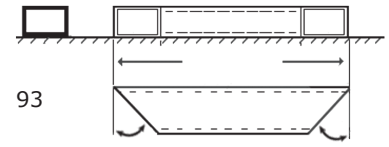
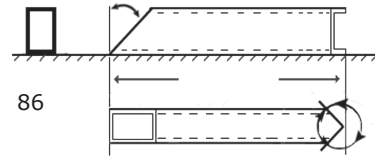

GEWINDEROHR GESCHWEISST SCHWARZ
EN10255 - MEDIUM

Zoll	mm	mm	6 mtr	kg/mtr
1/4	13,5	2,35	X	0,650
3/8	17,2	2,35	X	0,852
1/2	21,3	2,65	X	1,220
3/4	26,9	2,65	X	1,580
1	33,7	3,25	X	2,440
1 1/4	42,4	3,25	X	3,140

Zoll	mm	mm	6 mtr	kg/mtr
1 1/2	48,3	3,25	X	3,610
2	60,3	3,65	X	5,100
2 1/2	76,1	3,65	X	6,510
3	88,9	4,05	X	8,470
4	114,3	4,50	X	12,100

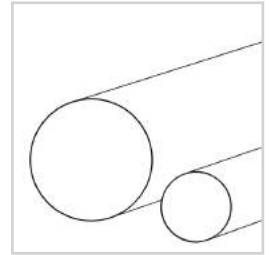

STRECKREDUZIERTES GEWINDEROHR SCHWARZ
EN10255 - MEDIUM

Zoll	mm	mm	6 mtr	kg/mtr
3/8	17,2	2,35	X	0,852
1/2	21,3	2,65	X	1,220
3/4	26,9	2,65	X	1,580
1	33,7	3,25	X	2,440

Zoll	mm	mm	6 mtr	kg/mtr
1 1/4	42,4	3,25	X	3,140
1 1/2	48,3	3,25	X	3,610
2	60,3	3,65	X	5,100

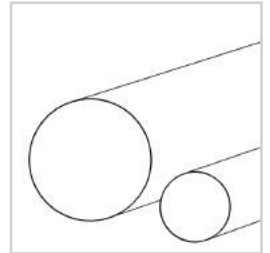

SCHWERES GEWINDEROHR SCHWARZ
EN10255 - HEAVY

Zoll	mm	mm	6 mtr	kg/mtr
1/2	21,3	3,25	X	1,450
3/4	26,9	3,25	X	1,900
1	33,7	4,05	X	2,970
1 1/4	42,4	4,05	X	3,840

Zoll	mm	mm	6 mtr	kg/mtr
1 1/2	48,3	4,05	X	4,430
2	60,3	4,50	X	6,170
2 1/2	76,1	4,50	X	7,900

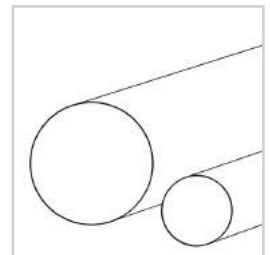

GEWINDEROHR NAHTLOS
EN10255 - MEDIUM

Zoll	mm	mm	6 mtr	kg/mtr
3/8	17,2	2,35	X	0,852
1/2	21,3	2,65	X	1,220
3/4	26,9	2,65	X	1,580
1	33,7	3,25	X	2,440

Zoll	mm	mm	6 mtr	kg/mtr
1 1/4	42,4	3,25	X	3,140
1 1/2	48,3	3,25	X	3,610
2	60,3	3,65	X	5,100

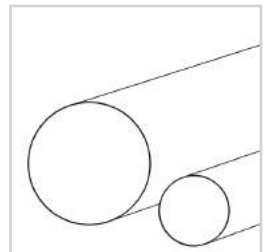

GEWINDEROHR GESCHWEISST VERZINKT
EN10255 - MEDIUM / EN10240-A1

Zoll	mm	mm	6 mtr	kg/mtr
1/4	13,5	2,35	X	0,679
3/8	17,2	2,35	X	0,890
1/2	21,3	2,65	X	1,270
3/4	26,9	2,65	X	1,650
1	33,7	3,25	X	2,550
1 1/4	42,4	3,25	X	3,280

Zoll	mm	mm	6 mtr	kg/mtr
1 1/2	48,3	3,25	X	3,770
2	60,3	3,65	X	5,330
2 1/2	76,1	3,65	X	6,800
3	88,9	4,05	X	8,850
4	114,3	4,50	X	12,640

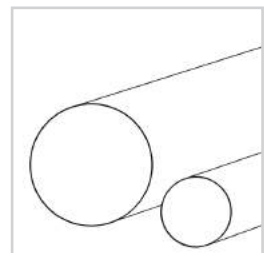

SCHWERES GEWINDEROHR VERZINKT
EN10255 - HEAVY / EN10240-A1

Zoll	mm	mm	6 mtr	kg/mtr
1/2	21,3	3,25	X	1,520
3/4	26,9	3,25	X	1,990
1	33,7	4,05	X	3,100

Zoll	mm	mm	6 mtr	kg/mtr
1 1/4	42,4	4,05	X	4,010
1 1/2	48,3	4,05	X	4,630
2	60,3	4,50	X	6,450

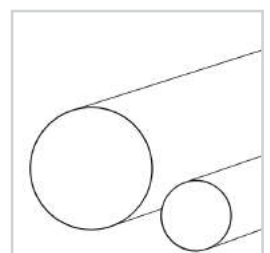

Wir erweitern ständig unser Lagerprogramm, nicht aufgeführte Abmessungen sind auf Anfrage lieferbar.

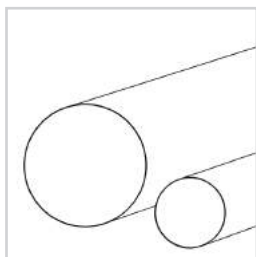

GEWINDEROHR NAHTLOS VERZINKT

EN10255 - MEDIUM / EN10240-A1

Zoll	mm	mm	6 mtr	kg/mtr	Zoll	mm	mm	6 mtr	kg/mtr
1/2	21,3	2,65	X	1,270	1 1/4	42,4	3,25	X	3,280
3/4	26,9	2,65	X	1,650	1 1/2	48,3	3,25	X	3,770
1	33,7	3,25	X	2,550	2	60,3	3,65	X	5,330

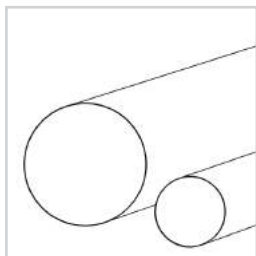

GELÄNDERROHR GESCHWEISST

EN10219

Zoll	mm	mm	6 mtr	kg/mtr	Zoll	mm	mm	6 mtr	kg/mtr
1/2	21,3	1,75	X	0,840	1 1/2	48,3	2	X	2,280
3/4	26,9	1,75	X	1,090	2	60,3	2	X	2,880
1	33,7	2	X	1,560	2 1/2	76,1	2	X	3,650
1 1/4	42,4	2	X	1,990					

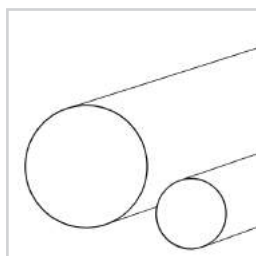

GELÄNDERROHR GESCHWEISST VERZINKT

EN10219/EN 10240 HL 6 UND 7 MTR

Zoll	mm	mm	6 mtr	7 mtr	kg/mtr	Zoll	mm	mm	6 mtr	7 mtr	kg/mtr
1/2	21,3	1,75	X		0,880	1 1/2	48,3	2	X	X	2,390
3/4	26,9	1,75	X		1,150	2	60,3	2	X	X	3,020
1	33,7	2	X	X	1,640	2 1/2	76,1	2	X		3,870
1 1/4	42,4	2	X	X	2,090						

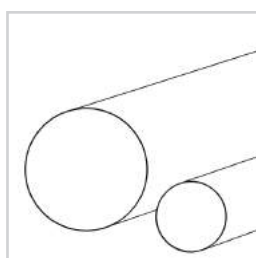

KONSTRUKTIONSRÖHR / STAHLROHR GESCHWEISST S235JRH

EN10219

Zoll	mm	mm	6 mtr	12 mtr	kg/mtr	Zoll	mm	mm	6 mtr	12 mtr	kg/mtr
1/2	21,3	2,00	X		0,950		76,1	5,00	X	X	8,770
3/4	26,9	2,00	X		1,230	3	88,9	2,90	X	X	6,150
1	33,7	2,50	X		1,920		88,9	3,20	X	X	6,760
1	33,7	2,90	X		2,200		88,9	4,00		X	8,380
	38,0	2,00	X		1,780		88,9	5,00	X	X	10,30
1 1/4	42,4	2,50	X		2,460		101,6	2,00	X		8,450
	42,4	3,60	X		3,440		101,6	2,90	X		7,060
1 1/2	48,3	2,50	X		2,820		101,6	3,60	X	X	8,700
	48,3	2,90	X		3,250		101,6	4,00		X	9,630
	48,3	3,60	X		3,970		101,6	5,00	X	X	11,900
	51,0	4,00	X		4,640		108,0	3,60	X		9,270
2	60,3	2,50	X		3,560		114,3	3,60	X		9,830
	60,3	2,90	X		4,110		114,3	5,00		X	13,500
	60,3	4,00	X		5,870		121,0	2,90	X		8,450
	60,3	5,00	X		6,820		133,0	4,00	X	X	12,700
	60,3	6,30	X		8,390		139,7	4,00	X	X	13,400
	63,5	2,90	X		4,330		139,7	5,00	X	X	16,600
	70,0	2,90	X		4,800		159,0	4,50	X		17,100
	70,0	4,00	X		6,510		168,3	4,50	X	X	18,200
2 1/2	76,1	2,60	X		4,710		168,3	6,30	X	X	25,200
	76,1	2,90	X		5,240		273,0	8,00		X	52,300
	76,1	4,00	X		7,110		273,0	10,00		X	64,900

Wir erweitern ständig unser Lagerprogramm, nicht aufgeführte Abmessungen sind auf Anfrage lieferbar.

STAHLROHR P235TR1 GESCHWEISST DRUCKGEPRÜFT
EN10217-1

mm	mm	6 mtr	12 mtr	kg/mtr	mm	mm	6 mtr	12 mtr	kg/mtr
38,0	2,0	X		1,780	121,0	4,0	X	X	11,500
38,0	2,6	X		2,270	121,0	5,0		X	14,300
38,0	3,2	X		2,750	121,0	6,3		X	17,800
42,4	2,6	X		2,550	121,0	8,0		X	22,300
42,4	2,9	X		2,820	127,0	4,0	X	X	12,100
42,4	5,0	X		4,610	127,0	5,0		X	15,000
44,5	2,6	X		2,690	127,0	6,3		X	18,800
48,3	5,0	X		5,340	127,0	8,0		X	23,500
48,3	6,3	X		6,530	133,0	2,9	X		9,300
51,0	2,6	X		3,100	133,0	4,0	X	X	12,700
57,0	2,9	X		3,870	133,0	5,0		X	15,800
60,3	2,9	X	X	4,110	133,0	6,3		X	19,700
60,3	5,0	X		6,820	133,0	8,0	X	X	24,700
60,3	6,3	X		8,390	133,0	10,0		X	30,300
60,3	8,0	X		10,300	139,7	4,0	X	X	13,400
63,5	2,9	X		4,330	139,7	5,0		X	16,600
70,0	2,9	X		4,800	139,7	6,3	X	X	20,700
70,0	5,0	X	X	8,010	139,7	8,0		X	26,000
70,0	6,3	X	X	9,900	139,7	10,0		X	32,000
76,1	2,9	X		5,240	152,4	4,5	X	X	16,400
76,1	4,0	X		7,110	152,4	6,3		X	22,700
76,1	5,0	X	X	8,770	154,0	8,0		X	28,500
76,1	6,3	X	X	10,800	159,0	2,9	X		11,200
76,1	8,0	X	X	13,400	159,0	4,5	X	X	17,100
82,5	2,6	X		5,120	159,0	6,3		X	23,700
82,5	3,2	X		6,260	159,0	8,0		X	29,800
82,5	5,0	X		9,560	159,0	10,0		X	36,700
88,9	3,2	X	X	6,760	168,3	4,5	X	X	18,200
88,9	4,0		X	8,380	168,3	6,3	X	X	25,200
88,9	5,0	X	X	10,300	168,3	8,0		X	31,600
88,9	6,3	X	X	12,800	168,3	10,0		X	39,000
88,9	8,0		X	16,000	177,8	4,5		X	19,200
88,9	10,0		X	19,500	177,8	6,3		X	26,600
101,6	2,9	X		7,060	177,8	8,0		X	33,500
101,6	3,2	X		7,820	193,7	3,2	X	X	15,000
101,6	3,6	X	X	8,700	193,7	4,5		X	21,000
101,6	4,0		X	9,630	193,7	6,3		X	29,100
101,6	4,5	X		10,800	193,7	8,0	X	X	36,600
101,6	5,0	X	X	11,900	193,7	10,0		X	45,300
101,6	6,3	X	X	14,800	219,1	4,5	X	X	23,800
101,6	8,0	X	X	18,500	219,1	6,3	X	X	33,100
101,6	10,0		X	22,600	219,1	8,0		X	41,600
108,0	2,9	X	X	7,520	219,1	10,0		X	51,600
108,0	3,6	X	X	9,270	244,5	6,3		X	37,000
108,0	5,0	X	X	12,700	273,0	5,0		X	33,000
108,0	6,3	X	X	15,800	273,0	6,3		X	41,400
114,3	3,2	X		8,770	273,0	8,0		X	52,300
114,3	3,6	X	X	9,830	323,9	5,6		X	44,000
114,3	5,0	X	X	13,500	323,9	6,3		X	49,300
114,3	6,3	X	X	16,800	323,9	8,0		X	62,300
114,3	8,0	X	X	21,000	406,4	6,3		X	62,200
114,3	10,0		X	25,700					

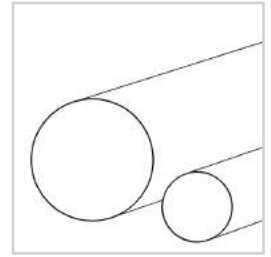

Wir erweitern ständig unser Lagerprogramm, nicht aufgeführte Abmessungen sind auf Anfrage lieferbar.

■ **STAHLROHR P235TR2 NAHTLOS NORMALWAND**
EN10216-1

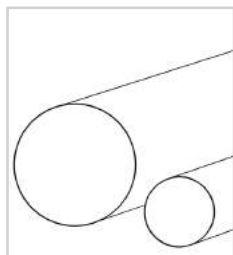

mm	mm	6 mtr	kg/mtr
60,3	2,9	X	4,110
88,9	3,2	X	6,760
114,3	3,6	X	9,830

■ **PRÄZISIONSSTAHLROHR E220/E235 GESCHWEISST**
EN10305-3

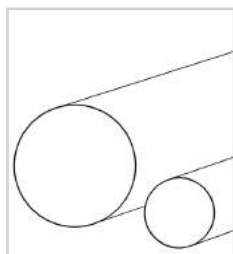

mm	mm	6 mtr	kg/mtr	mm	mm	6 mtr	kg/mtr
10,0	1,0	X	0,222	28,0	2,0	X	1,282
10,0	1,5	X	0,314	30,0	1,5	X	1,054
12,0	1,0	X	0,271	30,0	2,0	X	1,381
12,0	1,5	X	0,388	30,0	3,0	X	1,998
12,0	2,0	X	0,493	35,0	2,0	X	1,628
14,0	1,5	X	0,462	40,0	1,5	X	1,424
14,0	2,0	X	0,592	40,0	2,0	X	1,874
15,0	1,5	X	0,499	40,0	3,0	X	2,737
15,0	2,0	X	0,641	45,0	2,0	X	2,121
16,0	1,5	X	0,536	50,0	1,5	X	1,794
16,0	2,0	X	0,691	50,0	2,0	X	2,368
18,0	1,5	X	0,610	50,0	3,0	X	3,477
18,0	2,0	X	0,789	60,0	1,5	X	2,164
20,0	1,5	X	0,684	60,0	2,0	X	2,861
20,0	2,0	X	0,888	60,0	3,0	X	4,217
20,0	3,0	X	1,258	70,0	2,0	X	3,354
22,0	1,5	X	0,758	75,0	2,0	X	3,601
22,0	2,0	X	0,986	76,0	2,0	X	3,650
25,0	1,5	X	0,869	80,0	1,5	X	2,904
25,0	2,0	X	1,134	80,0	2,0	X	3,847
25,0	2,5	X	1,387	90,0	2,0	X	4,340
25,0	3,0	X	1,628	100,0	2,0	X	4,834

Wir erweitern ständig unser Lagerprogramm, nicht aufgeführte Abmessungen sind auf Anfrage lieferbar.

PRÄZISIONSTAHLROHR E235+C NAHTLOS
EN10305-1

mm	mm	6 mtr	kg/mtr	mm	mm	6 mtr	kg/mtr
8,0	2,0	X	0,296	28,0	3,0	X	1,850
10,0	1,5	X	0,314	30,0	2,0	X	1,381
10,0	2,0	X	0,395	30,0	2,5	X	1,695
10,0	2,5	X	0,462	30,0	3,0	X	1,998
12,0	1,0	X	0,271	30,0	4,0	X	2,565
12,0	1,2	X	0,320	30,0	5,0	X	3,083
12,0	1,5	X	0,388	30,0	6,0	X	3,551
12,0	2,0	X	0,493	32,0	2,0	X	1,480
12,0	2,5	X	0,586	32,0	6,0	X	3,847
12,0	3,0	X	0,666	35,0	2,5	X	2,004
13,0	1,0	X	0,296	35,0	5,0	X	3,699
14,0	1,5	X	0,462	36,0	2,0	X	1,677
14,0	2,0	X	0,592	38,0	2,5	X	2,189
14,0	3,0	X	0,814	38,0	3,0	X	2,589
15,0	1,5	X	0,499	40,0	2,0	X	1,874
15,0	2,0	X	0,641	40,0	2,5	X	2,312
15,0	2,5	X	0,771	40,0	3,0	X	2,737
15,0	3,0	X	0,888	40,0	4,0	X	3,551
16,0	1,0	X	0,370	40,0	5,0	X	4,316
16,0	1,5	X	0,536	40,0	6,0	X	5,031
16,0	2,0	X	0,691	40,0	7,5	X	6,011
16,0	2,5	X	0,832	40,0	8,0	X	6,313
16,0	3,0	X	0,962	40,0	10,0	X	7,398
16,0	4,0	X	1,184	42,0	2,0	X	1,973
17,0	2,0	X	0,740	45,0	2,0	X	2,121
18,0	1,0	X	0,419	45,0	5,0	X	4,932
18,0	1,5	X	0,610	45,0	6,5	X	6,172
18,0	2,0	X	0,789	50,0	2,0	X	2,368
18,0	2,5	X	0,857	50,0	2,5	X	2,929
18,0	3,0	X	1,110	50,0	3,0	X	3,477
20,0	2,0	X	0,888	50,0	4,0	X	4,538
20,0	2,5	X	1,079	50,0	5,0	X	5,549
20,0	3,0	X	1,258	50,0	6,0	X	6,511
20,0	3,5	X	1,424	50,0	8,0	X	8,286
20,0	4,0	X	1,578	50,0	10,0	X	9,865
20,0	4,5	X	1,720	60,0	3,0	X	4,217
20,0	5,0	X	1,850	60,0	5,0	X	6,782
22,0	2,0	X	0,986	60,0	10,0	X	12,331
22,0	3,0	X	1,406	70,0	5,0	X	8,015
25,0	1,0	X	0,592	75,0	2,5	X	4,470
25,0	2,0	X	1,134	80,0	5,0	X	9,248
25,0	2,5	X	1,387	100,0	3,0	X	7,176
25,0	3,0	X	1,628	100,0	5,0	X	11,714
25,0	4,0	X	2,072	100,0	10,0	X	22,195
25,0	5,0	X	2,466	120,0	5,0	X	14,180

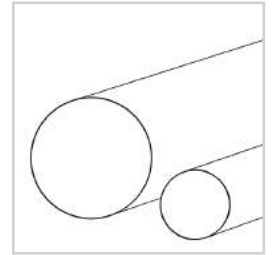

Wir erweitern ständig unser Lagerprogramm, nicht aufgeführte Abmessungen sind auf Anfrage lieferbar.

HYDRAULIKLEITUNGSROHR E235+N NAHTLOS
EN10305-4 GEBONDERT

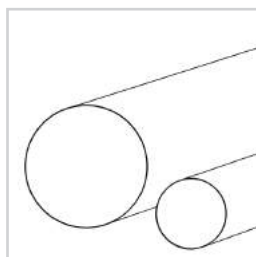

mm	mm	6 mtr	kg/mtr	mm	mm	6 mtr	kg/mtr
5,0	1,0	X	0,099	15,0	1,5	X	0,499
6,0	1,0	X	0,123	15,0	2,0	X	0,641
8,0	1,0	X	0,173	18,0	2,0	X	0,789
8,0	1,5	X	0,240	20,0	2,0	X	0,888
10,0	1,0	X	0,222	22,0	2,0	X	0,986
10,0	1,5	X	0,314	28,0	2,0	X	1,282
10,0	2,0	X	0,395	28,0	2,5	X	1,572
12,0	1,5	X	0,388	35,0	2,0	X	1,628
12,0	2,0	X	0,493				

HYDRAULIKLEITUNGSROHR E235+N NAHTLOS
EN10305-4 GELB CHROMATIERT/ BLAU PASSIVIERT

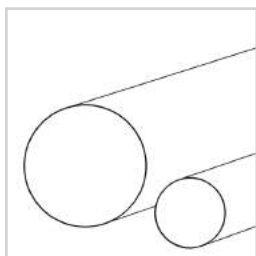

mm	mm	6 mtr	kg/mtr	mm	mm	6 mtr	kg/mtr
6	1,0	X	0,123	14	2,0	X	0,592
8	1,0	X	0,173	15	1,5	X	0,499
8	1,5	X	0,240	15	2,0	X	0,641
10	1,0	X	0,222	16	2,0	X	0,691
10	1,5	X	0,314	18	2,0	X	0,789
10	2,0	X	0,395	20	2,0	X	0,888
12	1,0	X	0,271	22	2,0	X	0,986
12	1,5	X	0,388	25	1,5	X	0,869
12	2,0	X	0,493	25	2,0	X	1,134

FLACHOVALROHR E220+CR. S2
EN10305-5/EN10025

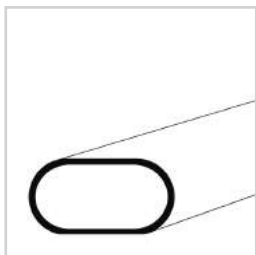

mm	mm	mm	6 mtr	kg/mtr
38	20	2	X	1,453
60	30	2	X	2,323

Wir erweitern ständig unser Lagerprogramm, nicht aufgeführte Abmessungen sind auf Anfrage lieferbar.

ANSCHLAGROHR S235JR

Profil	Profil	kg/mtr
RP 103	34	3,390
RP 104	34	3,090
RP 105	34	2,920
RP 106	34	2,460
RP 111	34	3,390
RP 112	34	3,500
RP 113	34	3,500
RP 114	34	3,200
RP 133	34	2,570
RP 138	34	3,020
RP 139	34	2,920
RP 140	34	3,030
RP 141	34	2,870
RP 142	34	2,890
RP 143	34	2,450
RP 144	34	1,990
RP 150	34	3,550
RP 169	34	2,450
RP 1050	34	3,080
RP 1092	34	4,500
RP 1191	34	2,930

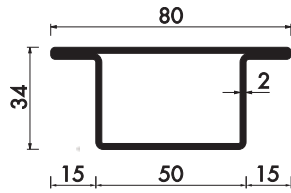

RP 103

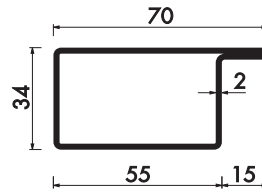

RP 104

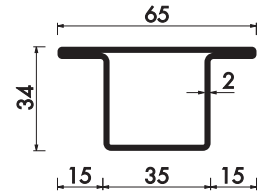

RP 105

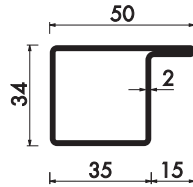

RP 106

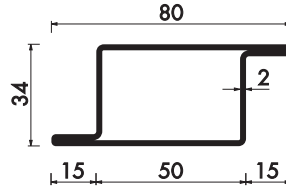

RP 111

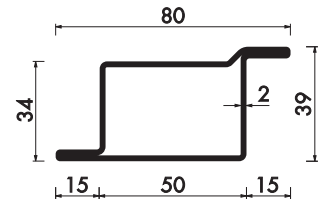

RP 112

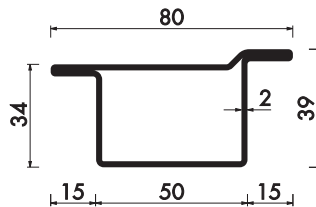

RP 113

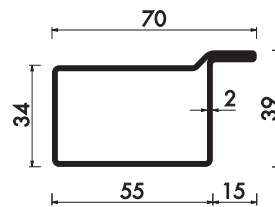

RP 114

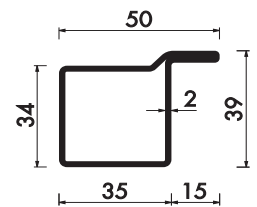

RP 133

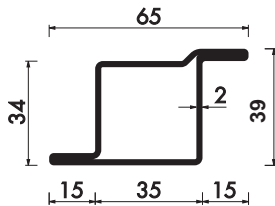

RP 138

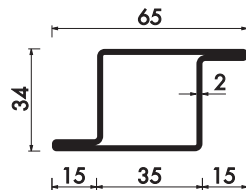

RP 139

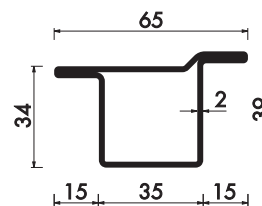

RP 140

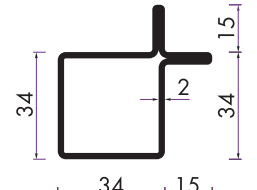

RP 141

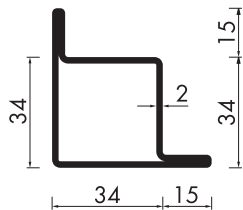

RP 142

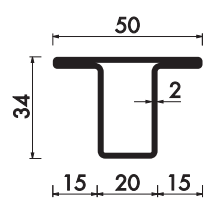

RP 143

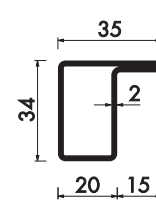

RP 144

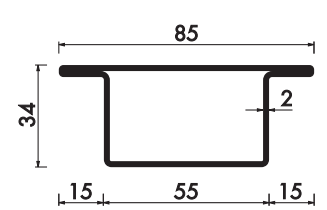

RP 150

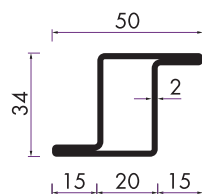

RP 169

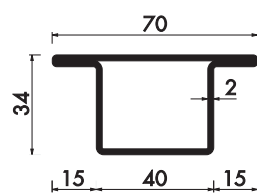

RP 1050

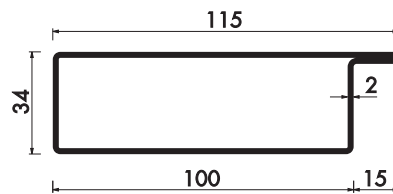

RP 1092

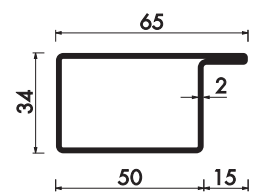

RP 1191

Wir erweitern ständig unser Lagerprogramm, nicht aufgeführte Abmessungen sind auf Anfrage lieferbar.

■ ANSCHLAGROHR S235JR

Profil	Profil	kg/mtr
RP 116	40	4,060
RP 152	40	3,270
RP 185	40	2,640
RP 1008	40	2,810
RP 1049	40	3,430
RP 1087	40	3,750
RP 1093	40	4,370
RP 1094	40	4,370
RP 1114	40	2,180
RP 1162	40	3,270
RP 1348	40	3,910
RP 1628	40	3,390
RP 1639	40	3,690
RP 1640	40	3,070
RP 1672	40	2,630
RP 1673	40	3,570
RP 1679	40	3,900
RP 1680	40	3,680
RP 1683	40	2,960
RP 1684	40	3,580
RP 1685	40	3,580
RP 1690	40	4,520
RP 1692	40	2,330
RP 1693	40	2,950
RP 1695	40	3,560
RP 1698	40	3,580

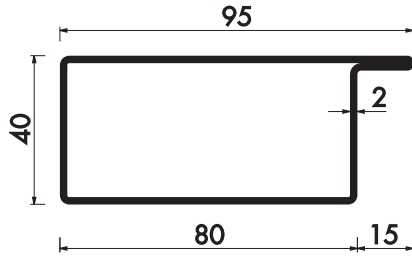

RP 116

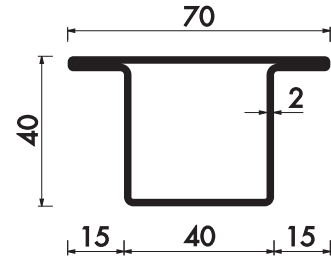

RP 152

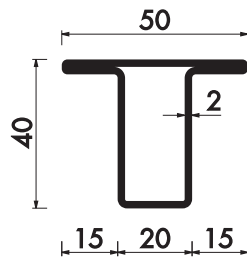

RP 185

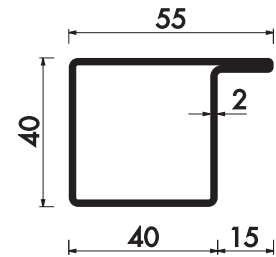

RP 1008

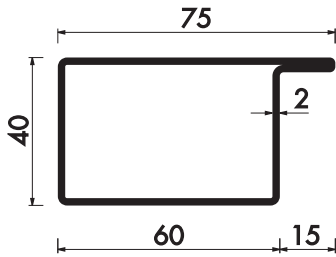

RP 1049

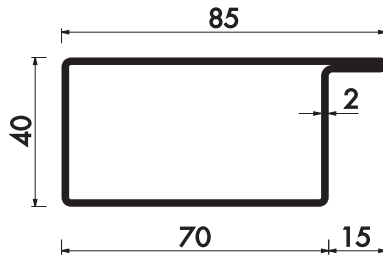

RP 1087

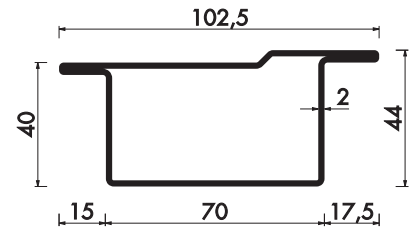

RP 1093

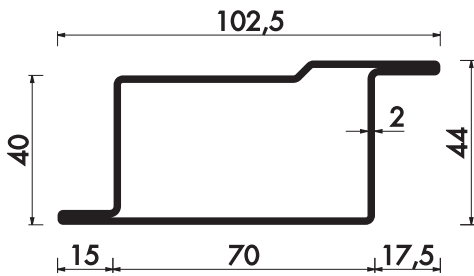

RP 1094

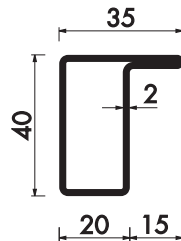

RP 1114

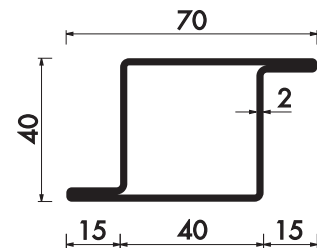

RP 1162

Wir erweitern ständig unser Lagerprogramm, nicht aufgeführte Abmessungen sind auf Anfrage lieferbar.

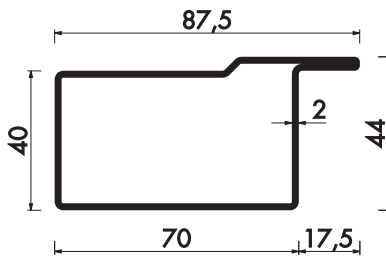

RP 1348

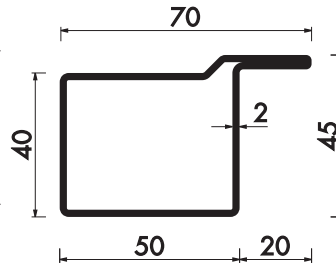

RP 1628

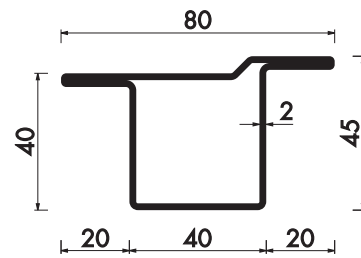

RP 1639

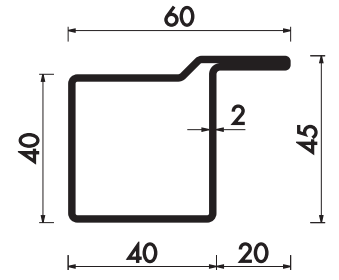

RP 1640

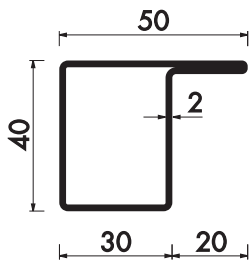

RP 1672

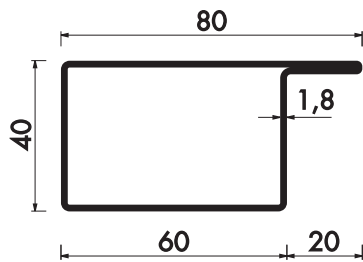

RP 1673

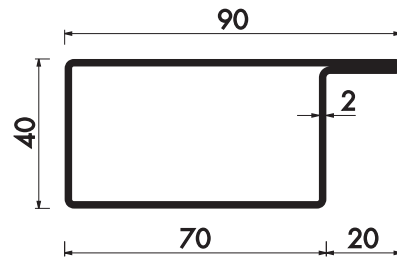

RP 1679

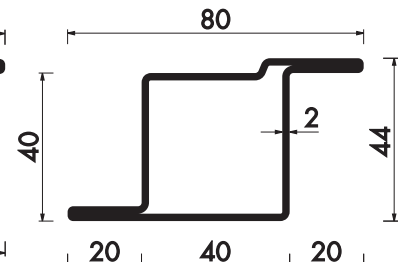

RP 1680

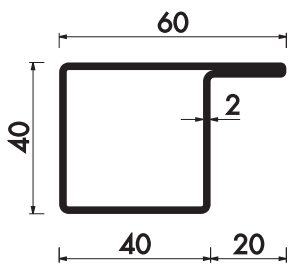

RP 1683

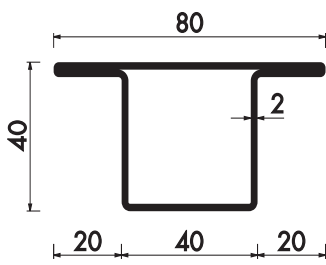

RP 1684

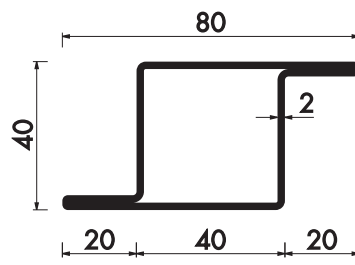

RP 1685

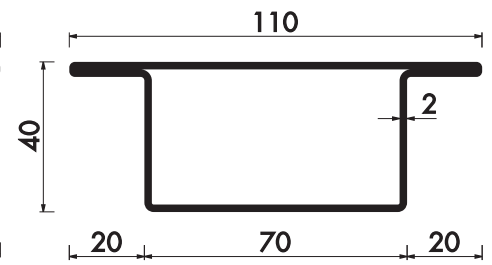

RP 1690

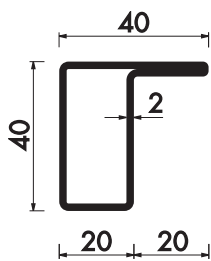

RP 1692

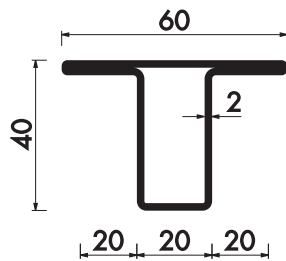

RP 1693

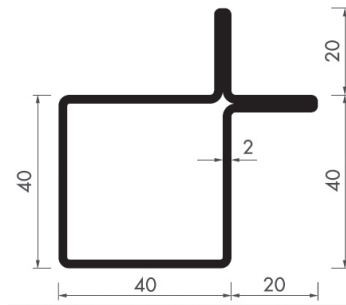

RP 1695

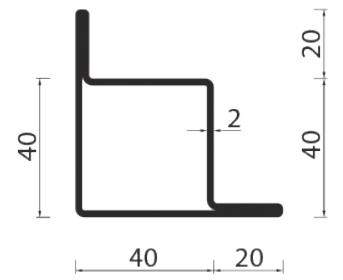

RP 1698

Wir erweitern ständig unser Lagerprogramm, nicht aufgeführte Abmessungen sind auf Anfrage lieferbar.

■ ANSCHLAGROHR S235JR

Profil	Profil	kg/mtr
RP 193	50	3,270
RP 195	50	3,270
RP 197	50	2,650
RP 1070	50	3,890
RP 1071	50	3,890
RP 1072	50	3,280
RP 1681	50	3,990
RP 1682	50	3,990
RP 1688	50	4,850
RP 1810	50	3,590
RP 1811	50	4,210
RP 1812	50	4,210

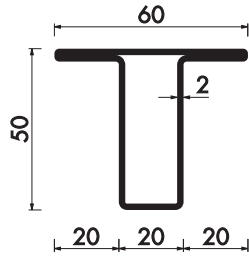

RP 193

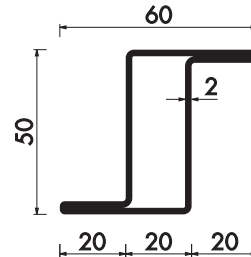

RP 195

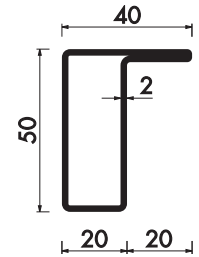

RP 197

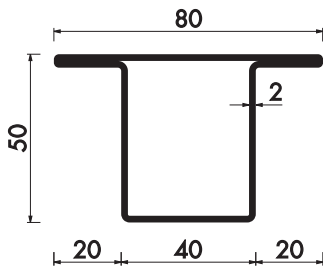

RP 1070

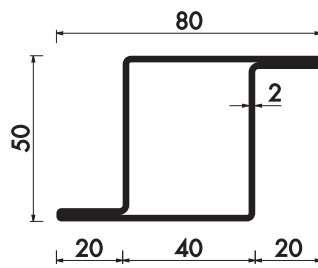

RP 1071

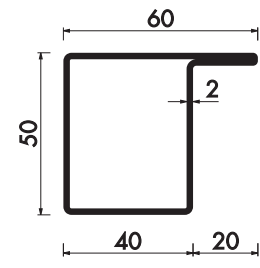

RP 1072

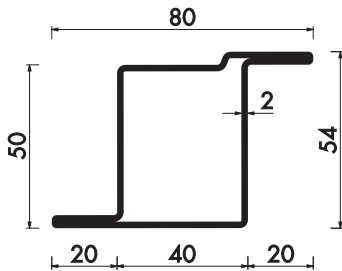

RP 1681

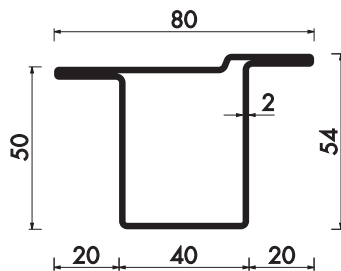

RP 1682

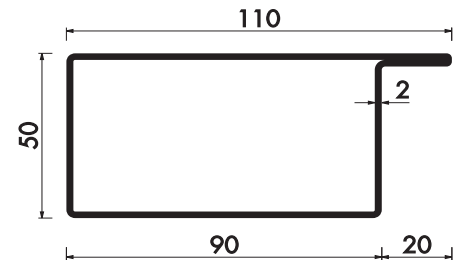

RP 1688

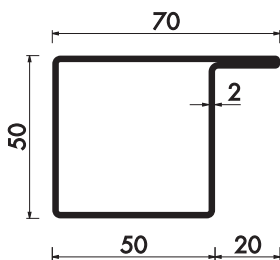

RP 1810

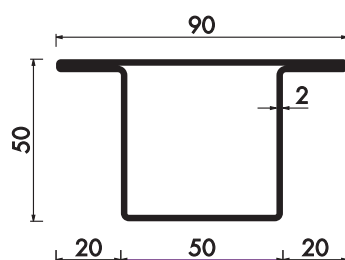

RP 1811

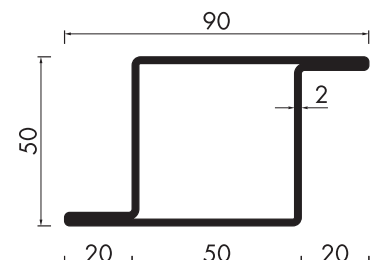

RP 1812

Wir erweitern ständig unser Lagerprogramm, nicht aufgeführte Abmessungen sind auf Anfrage lieferbar.

ANSCHLAGROHR S235JR

Profil	Profil	kg/mtr
RP 1592	60	3,950
RP 1594	60	4,210
RP 1596	60	4,210

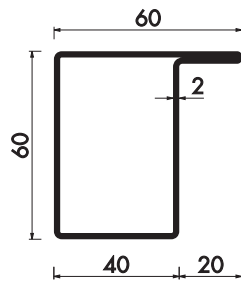

RP 1592

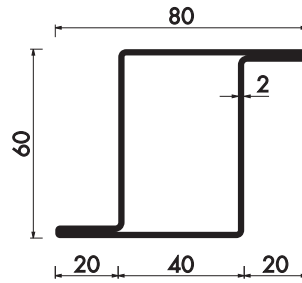

RP 1594

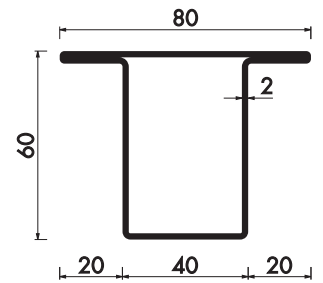

RP 1596

ANSCHLAGROHR S235JR

Profil	Profil	kg/mtr
RP 1593	80	6,010
RP 1595	80	6,780
RP 1597	80	6,760
RP 1645	80	6,054

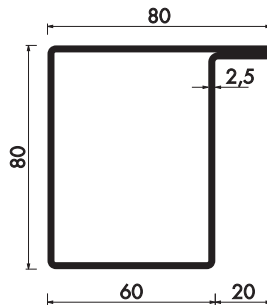

RP 1593

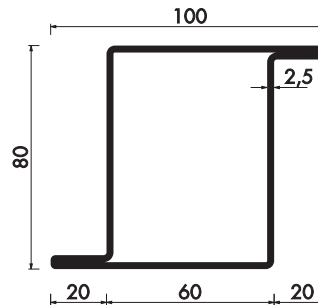

RP 1595

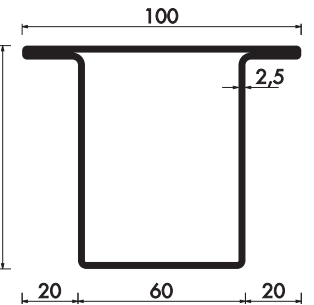

RP 1597

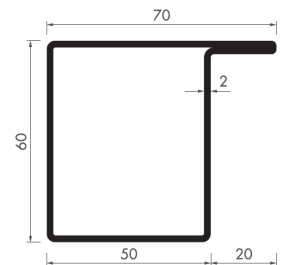

RP 1645

ANSCHLAGROHR S235JR

Profil	Profil	kg/mtr
RP 202	S	1,400

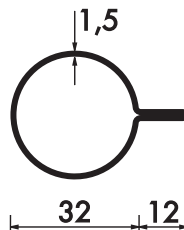

RP 202

ANSCHLAGROHR S235JR

Profil	Profil	kg/mtr
RP 1227	Hermetic 40	2,640
RP 1229	Hermetic 40	3,440
RP 1230	Hermetic 40	3,490
RP 1231	Hermetic 40	4,290
RP 1232	Hermetic 40	4,290

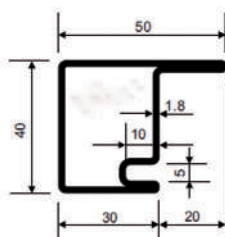

RP 1227

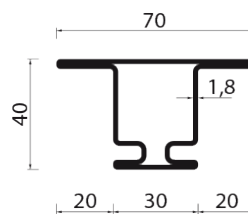

RP 1229

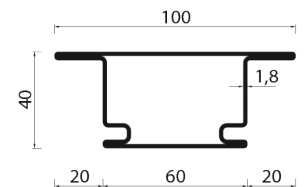

RP 1232

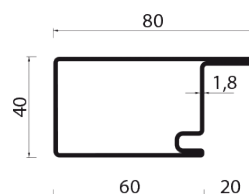

RP 1230

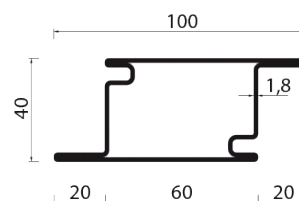

RP 1231

Wir erweitern ständig unser Lagerprogramm, nicht aufgeführte Abmessungen sind auf Anfrage lieferbar.

■ GLASHALTELEISTE AUS ALUMINIUM

Profil	kg/mtr
403021	0,230
403031	0,160
403080	0,310
403610	0,210
403620	0,250
403630	0,280
403640	0,359
403670	0,187

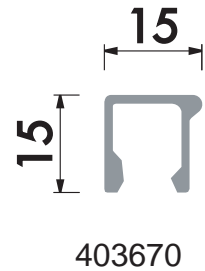
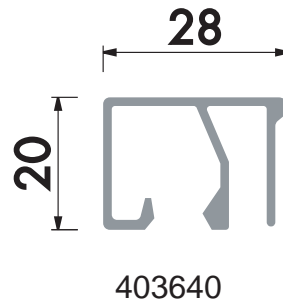
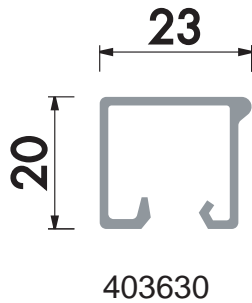
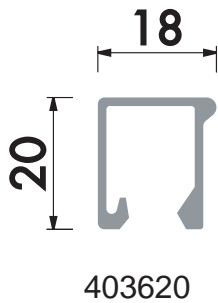
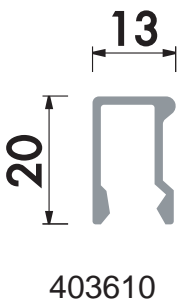
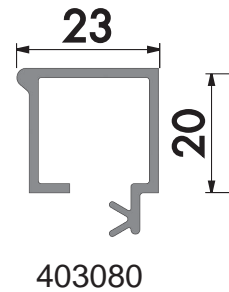
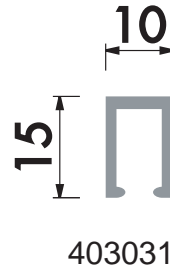
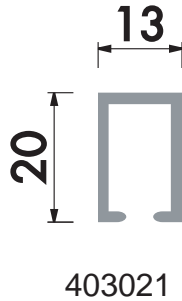

■ GLASHALTELEISTE AUS BANDVERZINKTEM STAHL

Profil	kg/mtr
400180	0,580
400230	0,680
400280	0,770

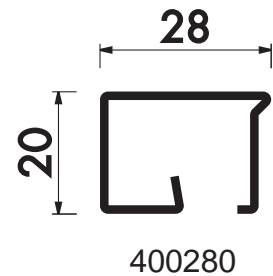
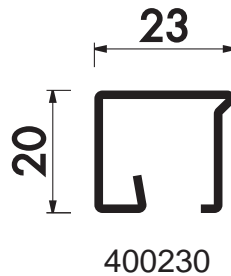
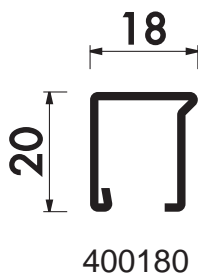

■ KLEMSCHRAUBEN

Profil
604100
604200
640500

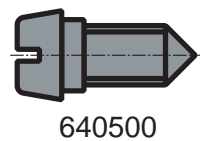
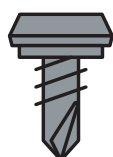

Wir erweitern ständig unser Lagerprogramm, nicht aufgeführte Abmessungen sind auf Anfrage lieferbar.

■ **DICTUNGSPROFILE EPDM VERGLASUNGSDICHTUNG**

Profil	VPE
300500	100 mtr.
300510	100 mtr.
300520	100 mtr.
300651	100 mtr.
304140	100 mtr.
304160	100 mtr.
304651	100 mtr.

3 mm



300500

3 mm



300510

5 mm



300520

3 mm



4 mm



304140

6 mm



304160

5 mm



304651
selbstkl.

Wir erweitern ständig unser Lagerprogramm, nicht aufgeführte Abmessungen sind auf Anfrage lieferbar.

■ **SIEDEROHRBOGEN NORM 3 S**
EN10253-1

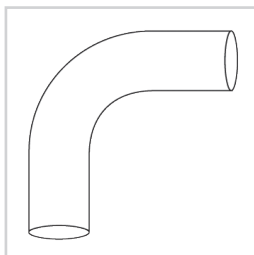

Zoll	Abmessung	90 Grad	180 Grad
1/2	21,3 x 2,0 mm	X	X
3/4	26,9 x 2,3 mm	X	X
1	33,7 x 2,6 mm	X	X
1 1/4	42,4 x 2,6 mm	X	X
1 1/2	48,3 x 2,6 mm	X	X
	51,0 x 2,6 mm	X	
	57,0 x 2,9 mm	X	
2	60,3 x 2,9 mm	X	X
	70,0 x 2,9 mm	X	
2 1/2	76,0 x 2,9 mm	X	
	82,5 x 3,2 mm	X	
3	88,9 x 3,2 mm	X	
3	88,9 x 3,2 mm	X	
	101,6 x 3,6 mm	X	
	108,0 x 3,6 mm	X	
4	114,3 x 3,6 mm	X	
	121,0 x 4,0 mm	X	
	133,0 x 4,0 mm	X	
6	139,7 x 4,0 mm	X	
	159,0 x 4,5 mm	X	
	168,3 x 4,5 mm	X	

■ **GELÄNDERROHRBOGEN**
EN10253-1

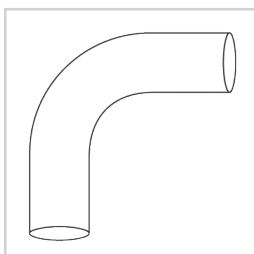

Zoll	Abmessung	90 Grad	180 Grad
1/2	21,3 x 1,75 mm	X	
3/4	26,9 x 1,75 mm	X	
1	33,7 x 2,00 mm	X	
1 1/4	42,4 x 2,00 mm	X	
1 1/2	48,3 x 2,00 mm	X	
2	60,3 x 2,00 mm	X	

Wir erweitern ständig unser Lagerprogramm, nicht aufgeführte Abmessungen sind auf Anfrage lieferbar.

ABDECKTELLER S235JR LEICHT GEWÖLBT
EN10253-1

Zoll	Abmessung
3/4	27,0 x 1,5 mm
1	33,0 x 2,0 mm
1 1/4	42,0 x 2,0 mm
1 1/2	48,0 x 2,0 mm
2	60,0 x 2,0 mm
	70,0 x 2,5 mm
	76,0 x 2,0 mm
	88,9 x 3,0 mm
	101,6 x 3,0 mm



KLÖPPERBODEN S235JR TIEFGEWÖLBT
DIN28011/EN10253-1

Zoll	Abmessung
1	33,7 x 3,0 mm
1 1/4	42,4 x 3,0 mm
1 1/2	48,3 x 3,0 mm
2	60,3 x 3,0 mm
	139,7 x 4,0 mm
	159,0 x 5,0 mm
	193,7 x 5,0 mm



ABDECKKAPPE VIERKANT
STAHL S235JR

Abmessung
50 x 50 mm
80 x 80 mm
100 x 100 mm

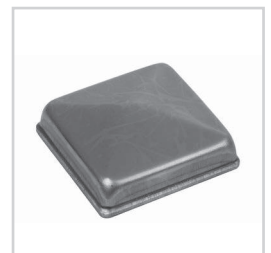

RONDE OHNE LÖCHER
STAHL S235JR

Außen Ø	Materialstärke
33 mm	4,0 mm
40 mm	4,0 mm
42 mm	4,0 mm
48 mm	4,0 mm
60 mm	4,0 mm
120 mm	4,0 mm
70 mm	6,0 mm
80 mm	6,0 mm
100 mm	6,0 mm
120 mm	6,0 mm
100 mm	8,0 mm
120 mm	8,0 mm
150 mm	8,0 mm



Wir erweitern ständig unser Lagerprogramm, nicht aufgeführte Abmessungen sind auf Anfrage lieferbar.

■ **HOHLKUGEL STARKWANDIG**
STAHL S235JR



Ø
40 mm
50 mm
60 mm
70 mm
80 mm
90 mm
100 mm
120 mm
150 mm

■ **MASSIVKUGEL MIT SACKLOCHGEWINDE**
STAHL S235JR



Ø	Gewinde
15 mm	M 5
20 mm	M 5
25 mm	M 6
30 mm	M 6
35 mm	M 8

■ **MASSIVKUGEL OHNE BOHRUNG**
STAHL S235JR



Ø
20 mm
25 mm
30 mm

■ **MASSIVKUGEL MIT SACKLOCH**
STAHL S235JR



Ø	Bohrung
25 mm	12,5 mm
35 mm	13,0 mm

Wir erweitern ständig unser Lagerprogramm, nicht aufgeführte Abmessungen sind auf Anfrage lieferbar.

ZACKENLEISTE ZUM ANSCHWEISSEN
STAHL S235 JRG2 BLANK

Abmessung	Länge
42,0 x 3,0 mm	2,0 mtr

**KUNSTSTOFF-HANDLAUF**
SCHWARZ

Abmessung
40 x 8 mm



U-BAUSTAHL S235JR (FAHRZEUGBAU)

EN10162/EN10025

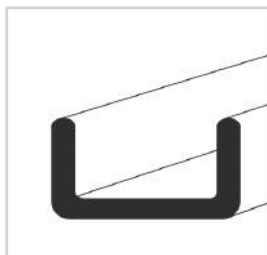

mm	mm	mm	6 mtr	12 mtr	kg/mtr	mm	mm	mm	6 mtr	12 mtr	kg/mtr
30	30	3	X		1,870	65	50	5	X		5,830
33	33	3	X		1,950	70	50	4	X		4,930
36	36	3	X		2,400	80	40	3	X		3,540
40	20	3	X		1,670	80	50	4	X		5,320
40	25	3	X		1,880	80	50	5	X		6,420
40	35	4	X		3,020	80	70	5	X		7,990
40	40	2	X		1,820	90	50	5	X		6,810
40	40	3	X		2,470	100	50	4	X		5,870
40	40	4	X		3,550	100	50	5	X		7,220
46	45	3	X		2,950	100	50	6	X		8,500
50	25	3	X		2,120	100	60	5	X		8,240
50	30	3	X		2,350	100	70	6	X		10,300
50	30	4	X		3,040	108	55	5	X		7,810
50	40	4	X		3,670	120	50	4	X		6,510
50	50	4	X		4,380	120	60	6	X		10,400
54	45	4	X		4,110	140	60	6	X		11,300
60	30	3	X		2,590	160	60	4		X	8,640
60	40	4	X		3,960	160	65	6	X		12,750
60	60	3	X		4,007	200	80	6	X		16,000
62	45	4	X		4,530						

U-BAUSTAHL S235JR VERZINKT

EN10162/EN10025

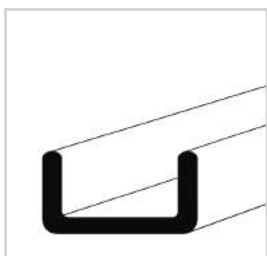

mm	mm	mm	6 mtr	kg/mtr	mm	mm	mm	6 mtr	kg/mtr
30	30	3	X	1,990	50	40	4	X	3,817
33	33	3	X	2,380	54	45	4	X	4,275
36	36	3	X	2,490	60	30	3	X	2,720
40	20	3	X	1,740	60	40	4	X	4,120
40	35	4	X	3,210	62	45	4	X	4,760
40	40	3	X	2,600	70	50	4	X	5,128
46	45	3	X	3,130	80	50	5	X	6,677
50	25	3	X	2,310	100	50	5	X	7,509
50	30	3	X	2,470					

U-BORDWANDPROFIL S235JR SCHWARZ

EN10162/EN10025

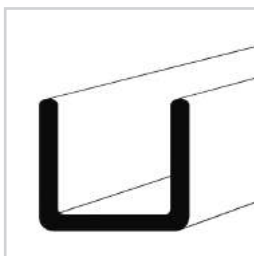

mm	mm	mm	6 mtr	kg/mtr	mm	mm	mm	6 mtr	kg/mtr
20	20	1,5	X	0,670	28	28	1,5	X	0,940
23	23	1,5	X	0,770	30	30	1,5	X	1,010
25	25	1,5	X	0,830	30	30	2	X	1,340

U-BORDWANDPROFIL S235JR VERZINKT

EN10162/EN10025

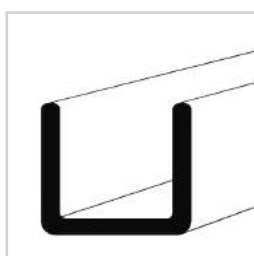

mm	mm	mm	6 mtr	kg/mtr	mm	mm	mm	6 mtr	kg/mtr
20	20	1,5	X	0,670	28	28	1,5	X	0,940
23	23	1,5	X	0,770	30	30	1,5	X	1,010
25	25	1,5	X	0,830					

Wir erweitern ständig unser Lagerprogramm, nicht aufgeführte Abmessungen sind auf Anfrage lieferbar.

TRENNWAND-MARKISENPROFIL S235JR
EN10162/EN10025

mm	mm	mm	mm	6 mtr	kg/mtr
30	30	10	2	X	1,580
40	40	10	2	X	2,050

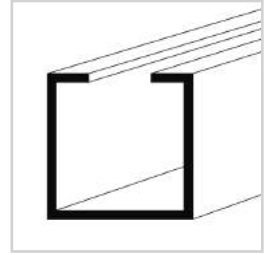
C-PROFIL S235JR (LEICHTBAU)
EN10162/EN10025

mm	mm	mm	mm	6 mtr	kg/mtr	mm	mm	mm	mm	6 mtr	kg/mtr
40	40	12	3	X	2,830	140	40	15	3	X	5,600
80	40	15	3	X	4,190	160	40	15	3	X	6,080
100	40	15	3	X	4,660	180	40	15	3	X	6,550
120	40	15	3	X	5,130	200	40	15	3	X	7,020

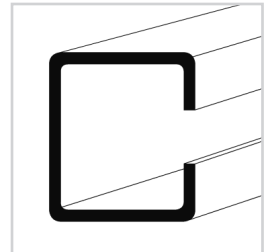
BRÜCKENGELÄNDERHANDLAUF S235JR UNTERGURT OFFEN
EN10162/EN10025

mm	mm	mm	mm	6 mtr	10 mtr	12 mtr	kg/mtr
80	50	16	4	X	X	X	5,770

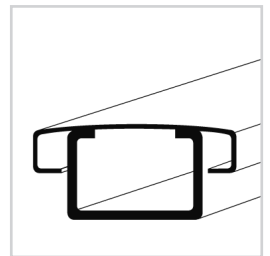
BRÜCKENGELÄNDERHANDLAUF S235JR OBERGURT OFFEN
EN10162/EN10025

mm	mm	mm	mm	6 mtr	10 mtr	12 mtr	kg/mtr
120	25	20	4	X	X	X	5,780

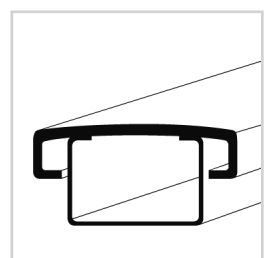

BRÜCKENGELÄNDERHANDLAUF S235JR EINTEILIG
EN10162/EN10025

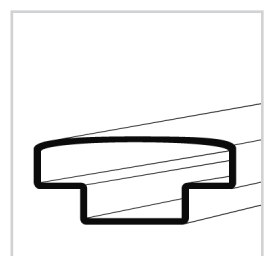
mm	mm	mm	mm	12 mtr	kg/mtr
120	55	65	4	X	10,000

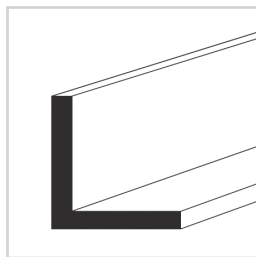

Wir erweitern ständig unser Lagerprogramm, nicht aufgeführte Abmessungen sind auf Anfrage lieferbar.

WINKELSTAHL S235JR SCHARFKANTIG GLEICHSCH.
EN10025



mm	mm	mm	6 mtr	kg/mtr	mm	mm	mm	6 mtr	kg/mtr
10	10	2	X	0,280	35	35	3	X	1,580
15	15	2	X	0,490	35	35	4	X	2,070
15	15	3	X	0,620	40	40	3	X	1,810
20	20	2	X	0,590	40	40	4	X	2,390
20	20	3	X	0,860	40	40	5	X	2,910
25	25	2	X	0,750	50	50	3	X	2,250
25	25	3	X	1,120	50	50	4	X	3,010
25	25	4	X	1,420	50	50	5	X	3,730
30	30	2	X	1,080	60	60	3	X	2,810
30	30	3	X	1,320	60	60	5	X	4,430

WINKELSTAHL S235JR SCHARFKANTIG UNGLEICHSCH.
EN10025

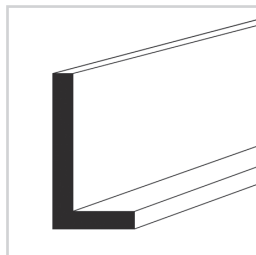

mm	mm	mm	6 mtr	kg/mtr	mm	mm	mm	6 mtr	kg/mtr
20	10	2	X	0,450	40	25	3	X	1,500
20	10	3	X	0,640	40	25	4	X	1,750
20	14	3	X	0,730	40	30	4	X	2,080
25	15	3	X	0,870	50	25	3	X	1,710
30	16	3	X	1,020	50	30	4	X	2,430
30	20	3	X	1,110	60	30	3	X	2,050
30	20	4	X	1,440	60	30	4	X	2,700
40	20	3	X	1,340	60	40	4	X	3,020
40	20	4	X	1,770	80	40	4	X	3,650

WINKELÄHNLICHER STAHL S235JR
EN10025

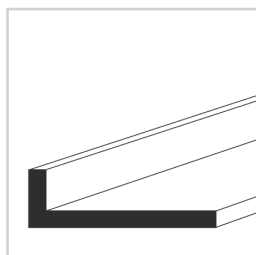

mm	mm	mm	mm	6 mtr	kg/mtr
53	16	10	8	X	4,000

BODENBELAGSWINKEL S235JR
EN10025

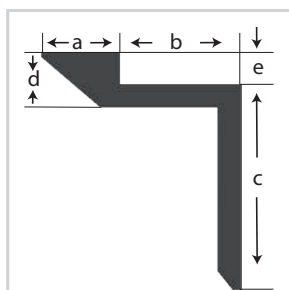

a mm	b mm	c mm	d mm	e mm	6 mtr	kg/mtr
16	24	40	10	5	X	3,300
20	30	50	10	5	X	4,120
20	30	50	12	7	X	4,480
20	30	50	14	7	X	5,500
20	30	50	17	10	X	5,700

Wir erweitern ständig unser Lagerprogramm, nicht aufgeführte Abmessungen sind auf Anfrage lieferbar.

■ ROLLADEN-U-STAHL S235JR SCHARFKANTIG
EN10025

mm	mm	mm	6 mtr	kg/mtr	mm	mm	mm	6 mtr	kg/mtr
12	12.5	2	X	0,520	28	40	2,75	X	2,230
12	20	1,5	X	0,540	30	30	2	X	1,350
15	15	1,5	X	0,490	30	30	2,5	X	1,670
15	20	1,5	X	0,600	30	30	3	X	1,850
20	20	2	X	0,880	33	50	3,75	X	3,750
20	20	2,5	X	1,080	36	36	3	X	2,400
25	25	2	X	1,120	40	40	3	X	2,690
25	25	2,5	X	1,380	50	50	4	X	4,460
25	25	4	X	2,100	60	55	5	X	6,290

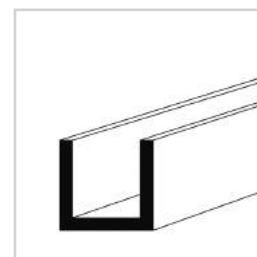

■ U-STAHL S235JR SCHARFKANTIG
EN10025

mm	mm	mm	mm	6 mtr	kg/mtr	mm	mm	mm	mm	6 mtr	kg/mtr
20	15	2,5	2,5	X	0,900	50	25	3		X	2,220
24	15	2		X	0,790	50	30	3,25	3,25	X	2,650
30	15	3		X	1,280	50	30	4		X	3,210
36	24	3		X	1,850	60	30	3	3	X	2,720
40	24	3,25	3,25	X	2,080	60	30	4	4	X	3,550
45	27	3,25	3,25	X	2,380	60	38	4	4	X	4,050

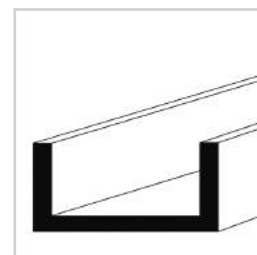

■ WELLENGITTER-U-STAHL S235JR
EN10025

mm	mm	mm	6 mtr	kg/mtr
10	30	2	X	0,980

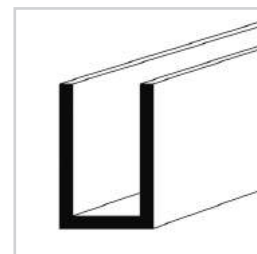

■ GITTER-U-STAHL S235JR (HESPENSTAHL)
EN10025

mm	mm	mm	mm	6 mtr	kg/mtr
25	8	4	5,5	X	1,140
30	8	4	5,5	X	1,240
40	13	5	7	X	2,250

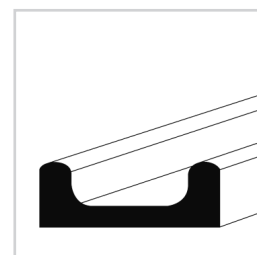

Wir erweitern ständig unser Lagerprogramm, nicht aufgeführte Abmessungen sind auf Anfrage lieferbar.

T-STAHL S235JR BREITFÜSSIG SCHARFKANTIG
DIN 59051/EN10025

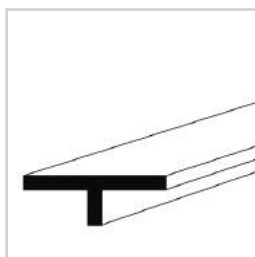

mm	mm	mm	6 mtr	kg/mtr
40	20	3	X	1,360
60	39	4	X	3,100

T-STAHL S235JR BREITFÜSSIG RUNDKANTIG
EN10055/EN10025

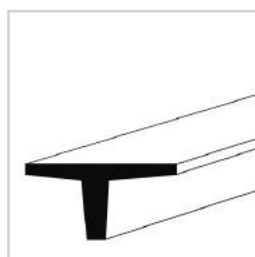

mm	mm	mm	6 mtr	12 mtr	kg/mtr	mm	mm	mm	6 mtr	12 mtr	kg/mtr
40	20	4,5	X		2,000	80	40	7	X	X	6,210
50	25	5	X		2,800	100	50	8,5	X	X	9,420
60	30	5,5	X		3,640	120	60	10	X	X	13,400
70	35	6	X		4,750						

Z-STAHL S235JR SCHARFKANTIG
DIN 1027/EN10025

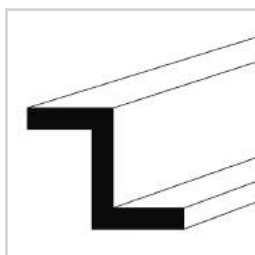

mm	mm	mm	mm	6 mtr	kg/mtr	mm	mm	mm	mm	6 mtr	kg/mtr
9	20	13	3	X	0,840	40	35	25	3	X	2,220
16	25	25	3,5	X	1,620	40	35	25	4	X	2,900
30	35	17	4	X	2,320	48	50	25	4	X	3,650

Z-STAHL S235JR RUNDKANTIG
DIN 1027/EN10025

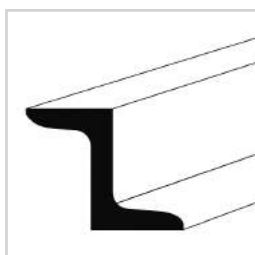

mm	mm	mm	mm	mm	6 mtr	kg/mtr
25	16	16	3,5		X	1,200
30	38	38	4,5	4	X	3,390
40	40	40	5	4,5	X	4,250
50	43	43	5,5	5	X	5,300
60	45	45	6	5	X	6,200
80	50	50	7	6	X	8,700
100	55	55	8	6,5	X	11,400
120	60	60	9	7	X	14,300
140	65	65	10	8	X	18,000
160	70	70	11	8,5	X	21,600

Wir erweitern ständig unser Lagerprogramm, nicht aufgeführte Abmessungen sind auf Anfrage lieferbar.

HANDLEISTENSTAHL S235JR
EN10025

mm	mm	mm	6 mtr	kg/mtr
40	18	8	X	3,300
50	22,5	10	X	5,300



HALBRUNDSTAHL S235JR
DIN 1018/EN10025

mm	mm	6 mtr	kg/mtr
16	8	X	0,790
20	10	X	1,220
30	15	X	2,750

mm	mm	6 mtr	kg/mtr
40	20	X	4,920
50	25	X	7,650
60	30	X	11,000

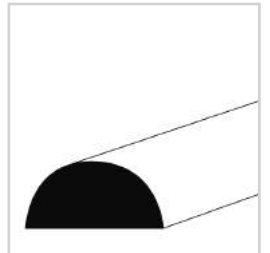

FLACHHALBRUNDSTAHL S235JR
DIN 1018/EN10025

mm	mm	6 mtr	kg/mtr
40	10	X	2,220

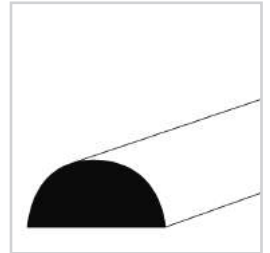

FLACHOVALSTAHL S235JR (STALLROSTPROFIL)
DIN 1018/EN10025

mm	mm	6 mtr	kg/mtr
20	10	X	1,390
24	11	X	1,960
25	8	X	1,450

mm	mm	6 mtr	kg/mtr
30	10	X	2,170
32	18	X	3,950
40	10	X	2,950

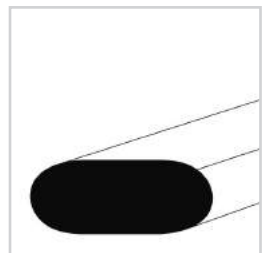

Wir erweitern ständig unser Lagerprogramm, nicht aufgeführte Abmessungen sind auf Anfrage lieferbar.

■ **SCHEUERLEISTENPROFIL S235JR**
EN10162/EN10025

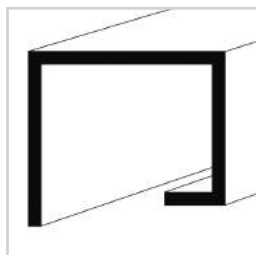

mm	mm	mm	mm	mm	6 mtr	kg/mtr
50	40	30	10	2	X	1,860
70	50	35	10	2,5	X	3,000

■ **KIPPER-Z-PROFIL S235JR**
EN10162/EN10025

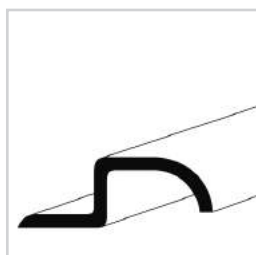

mm	mm	mm	mm	6 mtr	kg/mtr
40	31	45,5	3	X	2,830
45	34	62	4	X	4,460

■ **TREPPENSCHUTZSCHIENE**

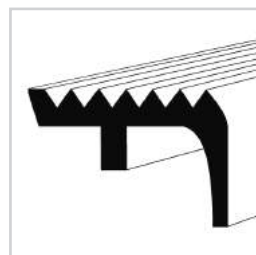

mm	6 mtr	kg/mtr
35	X	1,750

Wir erweitern ständig unser Lagerprogramm, nicht aufgeführte Abmessungen sind auf Anfrage lieferbar.

WELLENGITTER ROH

Maschenweite mm	1000 x 2000 mm	2000 x 3000 mm	2000 x 5000 mm
30 x 30 x 3			X
40 x 40 x 3,8		X	X
50 x 50 x 5			X

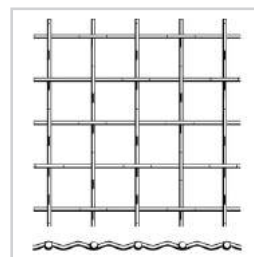
WELLENGITTER VERZINKT

Maschenweite mm	1000 x 2000 mm	2000 x 3000 mm	2000 x 5000 mm
10 x 10 x 2	X		
15 x 15 x 2,5	X		
20 x 20 x 2,5	X		
25 x 25 x 2,5	X		
30 x 30 x 3			X
40 x 40 x 3,8	X	X	X
50 x 50 x 5			X

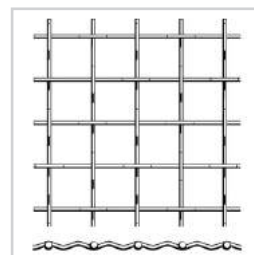

SCHWEISSGITTER ROH

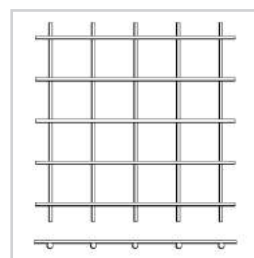
Maschenweite mm	1000 x 2000 mm	2000 x 3000 mm	2000 x 5000 mm
40 x 40 x 4		X	X
50 x 50 x 4		X	X
50 x 50 x 5		X	X

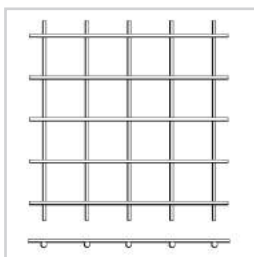

Wir erweitern ständig unser Lagerprogramm, nicht aufgeführte Abmessungen sind auf Anfrage lieferbar.

■ **SCHLOSSERMATTE ROH**



	Maschenweite mm	2150 x 5000 mm
Q 196	100 x 100 x 5	X

■ **SCHLOSSERMATTE VERZINKT**

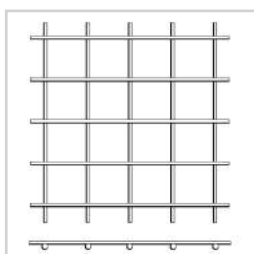

	Maschenweite mm	2150 x 5000 mm
Q 196	100 x 100 x 5	X

■ **GITTERMATTE
NICHT STATISCH**

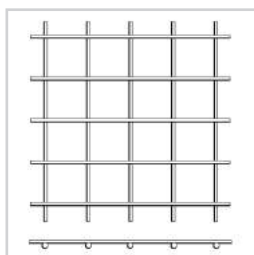

	Maschenweite mm	2150 x 5000 mm
N 141	50 x 50 x 3	X

Wir erweitern ständig unser Lagerprogramm, nicht aufgeführte Abmessungen sind auf Anfrage lieferbar.

QUALITÄTSSTAHL S355J2+AR FLACH
EN10058/EN10025

mm	mm	6 mtr	12 mtr	kg/mtr	mm	mm	6 mtr	12 mtr	kg/mtr
20	5	X		0,780	50	12	X		4,710
20	6	X		0,940	50	15	X		5,890
20	8	X		1,260	50	20	X		7,850
20	10	X		1,570	50	25	X		9,810
20	15	X		2,360	50	30	X	X	11,800
25	5	X		0,980	50	35	X		13,740
25	6	X		1,180	50	40	X		15,700
25	8	X		1,570	55	10	X		4,320
25	10	X		1,960	60	5	X		2,360
30	5	X		1,180	60	6	X		2,830
30	6	X		1,410	60	8	X		3,770
30	8	X		1,880	60	10	X		4,710
30	10	X		2,360	60	12	X		5,650
30	12	X		2,830	60	15	X		7,070
30	15	X		3,530	60	20	X		9,420
30	20	X		4,710	60	25	X		11,780
30	25	X		5,890	60	30	X		14,130
35	6	X		1,650	60	35	X		16,490
35	8	X		2,200	60	40	X	X	18,800
35	10	X		2,750	60	50	X		23,560
35	12	X		3,300	65	10	X		5,100
40	5	X		1,570	70	8	X		4,400
40	6	X		1,880	70	10	X		5,500
40	8	X		2,510	70	12	X		6,600
40	10	X		3,140	70	15	X		8,240
40	12	X		3,770	70	20	X		10,990
40	15	X		4,710	70	25	X		13,740
40	20	X		6,280	70	30	X		16,490
40	25	X		7,850	70	35	X		19,230
40	30	X	X	9,420	70	40	X		21,980
45	5	X		1,770	70	50	X	X	27,480
45	8	X		2,830	70	60	X		32,980
45	10	X		3,530	80	5	X		3,140
45	15	X		5,300	80	6	X		3,770
50	5	X		1,960	80	8	X		5,020
50	6	X		2,360	80	10	X		6,280
50	8	X		3,140	80	12	X		7,540
50	10	X		3,930	80	15	X		9,420

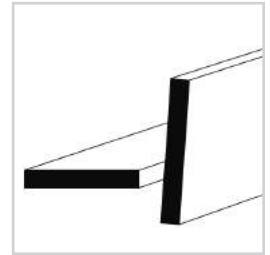

Wir erweitern ständig unser Lagerprogramm, nicht aufgeführte Abmessungen sind auf Anfrage lieferbar.

QUALITÄTSSTAHL S355J2+AR FLACH
EN10058/EN10025

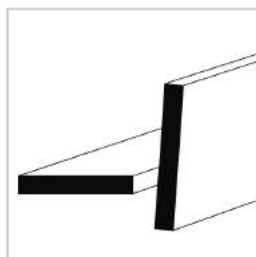

mm	mm	6 mtr	12 mtr	kg/mtr	mm	mm	6 mtr	12 mtr	kg/mtr
80	20	X		12,560	120	10	X		9,420
80	25	X		15,700	120	12	X		11,300
80	30	X		18,840	120	15	X		14,130
80	35	X		21,980	120	20	X		18,840
80	40	X		25,120	120	25	X		23,550
80	50	X		31,400	120	30	X		28,260
80	60	X	X	37,680	120	35	X		32,970
90	8	X		5,650	120	40	X		37,680
90	10	X		7,070	120	50	X		47,100
90	12	X		8,480	120	60	X		56,520
90	15	X		10,600	120	70	X		65,940
90	20	X		14,130	120	80	X		75,360
90	25	X		17,660	130	8	X		8,160
90	30	X		21,200	130	10	X		10,210
90	40	X		28,260	130	12	X		12,250
90	50	X		35,320	130	15	X		15,310
90	60	X		42,400	130	20	X		20,410
90	70	X		49,450	130	25	X		25,510
100	6	X		4,710	130	30	X		30,620
100	8	X		6,280	130	40	X		40,820
100	10	X		7,850	130	50	X		51,020
100	12	X		9,420	130	80	X		81,640
100	15	X		11,770	140	10	X		10,990
100	20	X		15,700	140	12	X		13,190
100	25	X		19,630	140	15	X		16,490
100	30	X		23,550	140	20	X		21,980
100	35	X		27,480	140	25	X		27,480
100	40	X		31,400	140	30	X		33,000
100	50	X		39,260	150	8	X		9,420
100	60	X		47,100	150	10	X		11,770
100	70	X		54,960	150	12	X		14,130
100	80	X		62,800	150	15	X		17,660
110	10	X		8,640	150	20	X		23,550
110	12	X		10,360	150	25	X		29,440
110	15	X		12,950	150	30	X		35,330
110	20	X		17,270	150	40	X		47,100
110	50	X		43,180	150	50	X		58,880
110	60	X		51,820	150	60	X		70,660
110	70	X		60,450	150	80	X		94,200
120	8	X		7,540					

Wir erweitern ständig unser Lagerprogramm, nicht aufgeführte Abmessungen sind auf Anfrage lieferbar.

QUALITÄTSSTAHL S355J2+AR RUND
EN10060/EN10025

mm	6 mtr	kg/mtr	mm	6 mtr	kg/mtr
12	X	0,888	95	X	55,640
14	X	1,210	100	X	61,650
15	X	1,390	105	X	68,000
16	X	1,580	110	X	74,620
18	X	2,000	115	X	81,500
20	X	2,470	120	X	88,800
22	X	2,980	125	X	96,300
24	X	3,550	130	X	104,000
25	X	3,850	140	X	121,000
27	X	4,490	150	X	139,000
30	X	5,550	160	X	158,000
35	X	7,550	170	X	178,000
36	X	7,990	180	X	200,000
40	X	9,860	190	X	223,000
45	X	12,500	200	X	247,000
50	X	15,400	210	X	272,000
55	X	18,700	220	X	298,000
60	X	22,200	230	X	326,200
65	X	26,050	240	X	355,000
70	X	30,200	250	X	385,300
75	X	34,680	260	X	417,000
80	X	39,460	270	X	449,000
85	X	44,550	300	X	559,000
90	X	49,900			

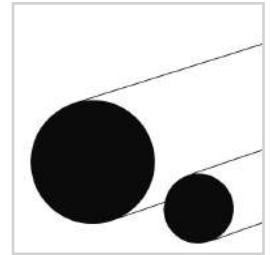

QUALITÄTSSTAHL S355J2+AR VIERKANT
EN10059/EN10025

mm	6 mtr	12 mtr	kg/mtr	mm	6 mtr	12 mtr	kg/mtr
20	X		3,140	70	X	X	38,500
25	X		4,910	80	X		50,200
30	X		7,070	90	X		63,600
35	X		9,620	100	X	X	78,500
40	X		12,600	110	X	X	95,000
45	X		15,900	120	X	X	113,000
50	X	X	19,600	130	X	X	133,000
55	X		23,700	140	X	X	154,000
60	X	X	28,300	150	X	X	177,000
65	X		33,200				

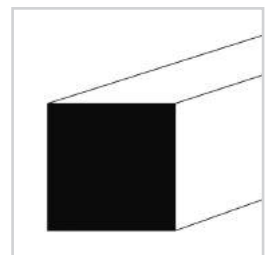

QUALITÄTSSTAHL S355J2+AR T-STAHL
EN10055/EN10025

mm	mm	12 mtr	kg/mtr
100	11	X	16,400
120	13	X	23,200

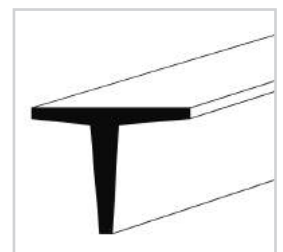

Wir erweitern ständig unser Lagerprogramm, nicht aufgeführte Abmessungen sind auf Anfrage lieferbar.

QUALITÄTSSTAHL S355J2+AR WINKEL GLEICHSCH.
EN10056/EN10025

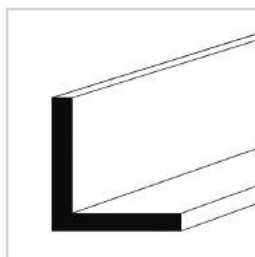

mm	mm	6 mtr	12 mtr	kg/mtr
30	3	X		1,360
40	4	X	X	2,420
40	5		X	2,970
50	5		X	3,770
50	6		X	4,470
60	6		X	5,420
70	7		X	7,380
80	8		X	9,660
80	10		X	11,900
90	9		X	12,200
100	8		X	12,200
100	10		X	15,100

mm	mm	6 mtr	12 mtr	kg/mtr
100	12		X	17,800
100	14		X	20,600
110	10		X	16,600
120	10		X	18,200
120	12		X	21,600
130	12		X	23,600
140	13		X	27,500
150	12		X	27,300
150	14		X	31,600
150	15		X	33,800
200	20		X	59,900
250	20		X	75,700

QUALITÄTSSTAHL S355J2+AR WINKEL UNGLEICHSCH.
EN10056/EN10025

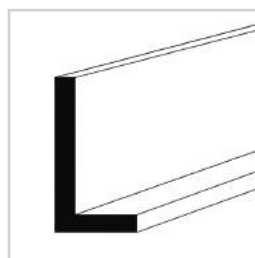

mm	mm	mm	6 mtr	12 mtr	kg/mtr
50	40	4		X	2,710
60	40	5		X	3,760
75	55	7		X	6,800
80	60	7		X	7,360
80	65	6		X	7,360
100	50	8		X	8,990
100	50	10		X	11,100
120	80	8		X	12,200
120	80	10		X	15,000
120	80	12		X	17,800

mm	mm	mm	6 mtr	12 mtr	kg/mtr
130	65	10		X	14,600
150	75	9		X	15,300
150	75	12		X	20,200
150	100	10		X	19,000
150	100	12		X	22,600
200	100	10		X	23,000
200	100	12		X	27,300
200	100	16		X	35,900
200	150	12		X	31,890
200	150	15		X	39,600

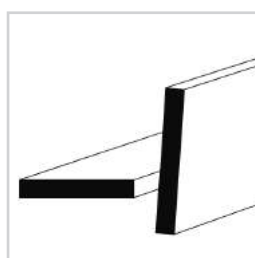

QUALITÄTSSTAHL S355J2+AR BREITFLACH
DIN 59200/EN10025

mm	mm	6 mtr	12 mtr	kg/mtr
160	10	X		12,800
160	12	X		15,400
160	15	X		19,200
160	20	X		25,600
160	25	X		31,400
160	30	X		38,400
160	40	X		51,200
180	10	X		14,400
180	12	X		17,300
180	15	X		21,600
180	20	X		28,800
180	25	X		35,360

mm	mm	6 mtr	12 mtr	kg/mtr
180	30	X		43,200
180	40	X		57,600
200	8	X		12,800
200	10	X		16,000
200	12	X		19,200
200	15	X		24,000
200	20	X		32,000
200	25	X		39,250
200	30	X		48,000
200	40	X		64,000
220	10	X		17,600
220	15	X		26,400



Wir erweitern ständig unser Lagerprogramm, nicht aufgeführte Abmessungen sind auf Anfrage lieferbar.

QUALITÄTSSTAHL S355J2+AR BREITFLACH
DIN 59200/EN10025

mm	mm	6 mtr	12 mtr	kg/mtr
220	20	X		35,200
220	25	X		43,180
240	15	X		28,800
240	20	X		38,400
250	10	X		20,000
250	15	X		30,000
250	20	X		40,000
250	25	X		49,050
250	30	X		60,000
280	15	X		32,970
280	20	X		43,960
300	10	X		24,000

mm	mm	6 mtr	12 mtr	kg/mtr
300	12	X		28,800
300	15	X		36,000
300	20	X		48,000
300	25	X		58,900
300	30	X		72,000
300	35	X		84,000
300	40	X		96,000
350	15	X		42,000
350	20	X		56,000
400	15	X		48,000
400	20	X		64,000

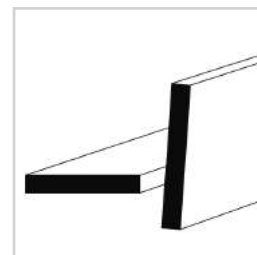

QUALITÄTSSTAHL S 355J2+AR U-STAHL
DIN1026/EN10025

mm	mm	mm	6 mtr	12 mtr	kg/mtr
40	20	5		X	2,960
50	25	5		X	3,980
65	42	5,5		X	7,300

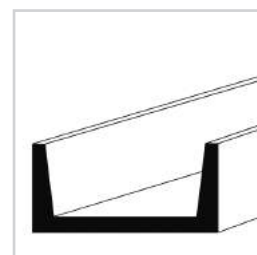

FORMSTAHL UNP S355J2
DIN 1025/EN10025

mm	12 mtr	kg/mtr
80	X	8,900
100	X	10,900
120	X	13,700
140	X	16,400

mm	12 mtr	kg/mtr
160	X	19,300
180	X	22,500
200	X	26,000

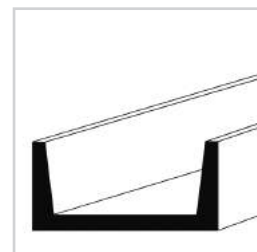

VERGÜTUNGSSTAHL C45E FLACH
EN10058/EN10083

mm	mm	6 mtr	12 mtr	kg/mtr
35	15	X		4,120
60	10	X		4,710
120	12	X		11,300

mm	mm	6 mtr	12 mtr	kg/mtr
120	20	X		18,840
150	15	X		17,660
150	20	X		23,550

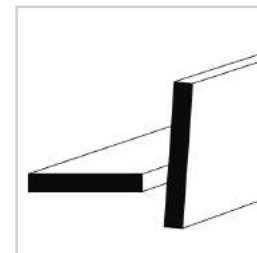

VERGÜTUNGSSTAHL C45E BREITFLACH
EN10058/EN10083

mm	mm	6 mtr	kg/mtr
160	20	X	25,120
180	15	X	21,200
180	20	X	28,260
200	20	X	31,400

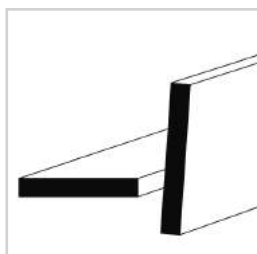

Wir erweitern ständig unser Lagerprogramm, nicht aufgeführte Abmessungen sind auf Anfrage lieferbar.

BLANKSTAHL S235JRC+C H11 FLACH
EN10277/EN10278/EN10025

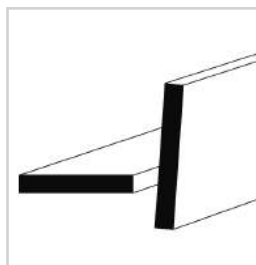

mm	mm	3 mtr	6 mtr	kg/mtr	mm	mm	3 mtr	6 mtr	kg/mtr
5	4	X		0,157	20	15	X	X	2,360
6	4	X		0,189	20	16	X		2,515
7	3	X		0,165	22	3	X		0,518
8	3	X		0,189	22	4	X		0,691
8	4	X		0,251	22	5	X		0,860
8	5	X		0,315	22	6	X		1,040
8	6	X		0,375	22	8	X		1,380
10	2	X		0,157	22	10	X		1,730
10	3	X		0,236	25	2	X		0,393
10	4	X		0,314	25	3	X		0,589
10	5	X		0,393	25	4	X		0,785
10	6	X		0,472	25	5	X		0,980
10	8	X		0,630	25	6	X		1,180
12	3	X		0,283	25	8	X		1,570
12	4	X		0,377	25	10	X		1,960
12	5	X		0,471	25	12	X		2,360
12	6	X		0,570	25	14	X		2,740
12	8	X		0,754	25	15	X	X	2,940
12	10	X		0,940	25	16	X		3,140
14	3	X		0,330	25	18	X		3,530
14	4	X		0,440	25	20	X		3,930
14	5	X		0,550	28	6	X		1,320
14	6	X		0,660	28	10	X		2,200
14	8	X		0,880	28	12	X		2,640
15	2	X		0,230	30	2	X		0,471
15	3	X		0,353	30	3	X		0,707
15	4	X		0,471	30	4	X		0,942
15	5	X		0,589	30	5	X		1,180
15	6	X		0,707	30	6	X		1,410
15	7	X		0,819	30	8	X		1,880
15	8	X		0,942	30	10	X		2,360
15	10	X		1,180	30	12	X	X	2,830
15	12	X		1,415	30	15	X	X	3,530
16	2	X		0,250	30	16	X		3,770
16	3	X		0,377	30	20	X	X	4,710
16	4	X		0,502	30	25	X		5,890
16	5	X		0,630	32	5	X		1,260
16	6	X		0,750	32	8	X		2,010
16	8	X		1,005	32	10	X		2,510
16	10	X		1,260	35	3	X		0,824
16	12	X		1,505	35	4	X		1,099
18	3	X		0,425	35	5	X		1,370
18	4	X		0,565	35	6	X		1,650
18	5	X		0,710	35	8	X		2,200
18	6	X		0,850	35	10	X	X	2,750
18	8	X		1,130	35	12	X		3,300
18	10	X		1,410	35	15	X		4,120
18	12	X		1,700	35	16	X		4,400
20	2	X		0,314	35	18	X		4,950
20	3	X		0,471	35	20	X		5,500
20	4	X		0,628	35	25	X	X	6,870
20	5	X		0,790	35	30	X		8,240
20	6	X		0,940	40	3	X		0,942
20	8	X		1,260	40	4	X		1,256
20	10	X		1,570	40	5	X		1,570
20	12	X		1,880	40	6	X		1,880

Wir erweitern ständig unser Lagerprogramm, nicht aufgeführte Abmessungen sind auf Anfrage lieferbar.

BLANKSTAHL S235JRC+C H11 FLACH

EN10277/EN10278/EN10025

mm	mm	3 mtr	6 mtr	kg/mtr	mm	mm	3 mtr	6 mtr	kg/mtr
40	8	X		2,510	60	35	X		16,490
40	10	X	X	3,140	60	40	X		18,840
40	12	X	X	3,770	60	50	X		23,560
40	15	X	X	4,710	65	8	X		4,080
40	16	X		5,020	65	10	X		5,100
40	18	X	X	5,650	65	12	X		6,120
40	20	X	X	6,280	65	15	X		7,650
40	25	X	X	7,850	65	20	X		10,210
40	30	X	X	9,420	70	4	X		2,198
40	35	X		10,990	70	5	X		2,750
45	3	X		1,060	70	6	X		3,300
45	4	X		1,413	70	8	X		4,400
45	5	X		1,766	70	10	X		5,500
45	6	X		2,120	70	12	X		6,600
45	8	X		2,830	70	15	X		8,240
45	10	X		3,530	70	20	X		10,990
45	12	X		4,240	70	25	X		13,740
45	15	X		5,300	70	30	X		16,490
45	20	X		7,070	70	35	X		19,230
45	25	X		8,830	70	40	X	X	21,980
45	30	X		10,600	70	50	X		27,400
45	35	X		12,360	75	12	X		7,070
50	3	X		1,178	75	20	X		11,780
50	4	X		1,570	80	4	X	X	2,510
50	5	X		1,960	80	5	X		3,140
50	6	X		2,360	80	6	X	X	3,770
50	8	X		3,140	80	8	X	X	5,020
50	10	X	X	3,930	80	10	X		6,280
50	12	X	X	4,710	80	12	X	X	7,540
50	15	X	X	5,890	80	15	X	X	9,420
50	16	X		6,280	80	16	X		10,050
50	20	X	X	7,850	80	20	X	X	12,560
50	25	X	X	9,810	80	25	X	X	15,600
50	30	X	X	11,780	80	30	X	X	18,840
50	35	X		13,740	80	35	X		21,980
50	40	X	X	15,700	80	40	X	X	25,120
55	5	X		2,160	80	50	X	X	31,400
55	6	X		2,590	80	60	X	X	37,680
55	10	X		4,320	90	5	X		3,530
55	12	X		5,180	90	6	X		4,240
55	15	X		6,480	90	8	X		5,650
55	20	X		8,640	90	10	X		7,070
55	25	X		10,790	90	12	X		8,480
60	3	X		1,413	90	15	X		10,600
60	4	X		1,884	90	20	X	X	14,130
60	5	X		2,360	90	25	X		17,660
60	6	X	X	2,830	90	30	X		21,200
60	8	X	X	3,770	90	40	X		28,260
60	10	X	X	4,710	90	50	X		35,320
60	12	X	X	5,650	90	60	X		42,400
60	14	X		6,600	100	4	X		3,140
60	15	X	X	7,070	100	5	X		3,930
60	16	X		7,540	100	6	X		4,710
60	18	X		8,480	100	8	X		6,280
60	20	X	X	9,420	100	10	X	X	7,850
60	25	X		11,780	100	12	X	X	9,420
60	30	X	X	14,130	100	15	X		11,770

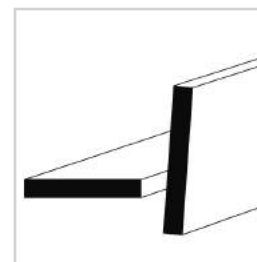

Wir erweitern ständig unser Lagerprogramm, nicht aufgeführte Abmessungen sind auf Anfrage lieferbar.

BLANKSTAHL S235JRC+C H11 FLACH
EN10277/EN10278/EN10025

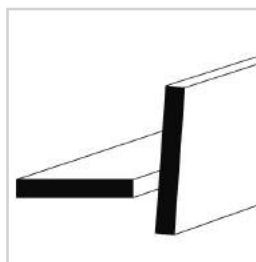

mm	mm	3 mtr	6 mtr	kg/mtr	mm	mm	3 mtr	6 mtr	kg/mtr
100	16	X		12,560	150	25	X		29,440
100	20	X	X	15,700	150	30	X		35,330
100	25	X		19,630	150	32	X		37,680
100	30	X	X	23,550	150	35	X		41,210
100	32	X		25,120	150	40	X		47,100
100	35	X		27,480	150	50	X		58,880
100	40	X		31,400	150	60	X		70,700
100	50	X		39,260	160	6	X		7,540
100	60	X	X	47,100	160	8	X		10,050
110	6	X		5,180	160	10	X		12,560
110	8	X		6,910	160	12	X		15,070
110	10	X		8,640	160	15	X		18,840
110	12	X	X	10,360	160	20	X		25,120
110	15	X		12,950	160	25	X		31,400
110	20	X		17,270	160	30	X		37,680
110	25	X		21,600	160	40	X		50,240
110	30	X		25,910	160	50	X		62,800
110	35	X		30,223	180	6	X		8,478
120	5	X		4,710	180	8	X		11,300
120	6	X		5,650	180	10	X		14,130
120	8	X		7,540	180	12	X		16,956
120	10	X		9,420	180	15	X		21,200
120	12	X		11,300	180	20	X		28,260
120	15	X		14,130	180	25	X		35,360
120	20	X	X	18,840	180	30	X	X	42,390
120	25	X		23,550	180	40	X		56,520
120	30	X		28,260	200	5	X		7,850
120	40	X		37,680	200	6	X		9,420
120	50	X		47,100	200	8	X		12,560
120	60	X		56,520	200	10	X		15,700
120	80	X		75,400	200	12	X		18,840
125	15	X		14,720	200	15	X		23,550
130	6	X		6,120	200	20	X		31,400
130	8	X	X	8,160	200	25	X		39,250
130	10	X		10,210	200	30	X		47,100
130	12	X		12,250	200	40	X		62,800
130	15	X		15,310	200	50	X		78,500
130	20	X		20,410	200	60	X		96,000
130	25	X		25,510	220	10	X		17,270
130	30	X		30,620	220	12	X		20,724
140	6	X		6,590	220	15	X		25,905
140	8	X		8,790	220	20	X		34,540
140	10	X		10,990	220	30	X	X	51,810
140	12	X		13,190	250	8	X		15,700
140	15	X		16,490	250	10	X		19,625
140	20	X		21,980	250	12	X		23,550
140	25	X		27,480	250	15	X		29,440
140	30	X		32,970	250	20	X		39,250
140	40	X		43,960	250	25	X		49,063
140	50	X		54,960	250	30	X		58,880
150	5	X		5,890	250	40	X		78,500
150	6	X		7,070	300	10	X		23,550
150	8	X		9,420	300	12	X		28,260
150	10	X		11,770	300	15	X		35,330
150	12	X		14,130	300	20	X		47,100
150	15	X		17,660	300	25	X		58,900
150	20	X		23,550	300	30	X		70,660

Wir erweitern ständig unser Lagerprogramm, nicht aufgeführte Abmessungen sind auf Anfrage lieferbar.

BLANKSTAHL S235JRC+C H11 FLACH

EN10277/EN10278/EN10025

mm	mm	3 mtr	6 mtr	kg/mtr
300	40	X		94,200
350	12	X		32,970
350	15	X		41,213
350	20	X		54,950

mm	mm	3 mtr	6 mtr	kg/mtr
400	10	X		31,400
400	12	X		37,680
400	15	X		47,100
400	20	X		62,800

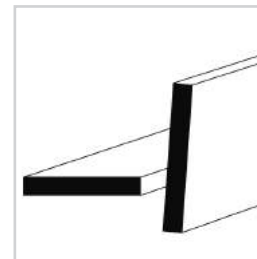
BLANKSTAHL C45+C H11 FLACH

EN10277/EN10278/EN10083

mm	mm	3 mtr	6 mtr	kg/mtr
30	6		X	1,410
35	15		X	4,120
40	8		X	2,510
40	10		X	3,140
40	15		X	4,710
40	20	X		6,280
40	25	X		7,850
40	30	X		9,420
45	12		X	4,240
50	20		X	7,850
50	35	X		13,740

mm	mm	3 mtr	6 mtr	kg/mtr
60	10		X	4,710
60	40	X		18,840
80	12		X	7,540
100	15		X	11,770
100	20	X		15,700
100	40		X	31,400
100	50	X	X	39,300
120	15	X		14,100
120	20	X		18,800
120	40		X	37,700
120	50		X	47,100

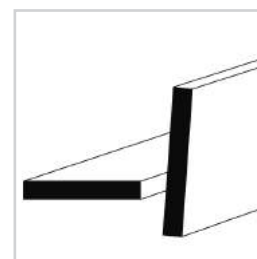
BLANKSTAHL S235JRC+C/SH H9 RUND

EN10277/EN10278/EN10025

mm	3 mtr	6 mtr	kg/mtr
3	X		0,055
4	X		0,099
5	X		0,154
6	X	X	0,222
7	X		0,302
8	X	X	0,395
9	X	X	0,499
10	X	X	0,617
11	X	X	0,746
12	X	X	0,888
13		X	1,040
14		X	1,210
15		X	1,390
16		X	1,580
17		X	1,782
18		X	2,000
19		X	2,230
20		X	2,466
22		X	2,980
23		X	3,261
24		X	3,550
25		X	3,850

mm	3 mtr	6 mtr	kg/mtr
26		X	4,170
28		X	4,830
30		X	5,550
32		X	6,310
35		X	7,550
36		X	7,990
38		X	8,900
40		X	9,860
42		X	10,900
45		X	12,500
50		X	15,400
55		X	18,700
60		X	22,200
65		X	26,050
70		X	30,200
75		X	34,700
80		X	39,500
90		X	49,900
100		X	61,700
110		X	74,600
120		X	88,800

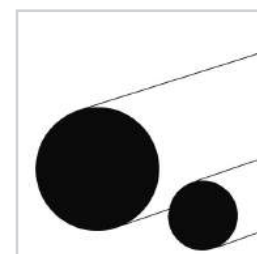

Wir erweitern ständig unser Lagerprogramm, nicht aufgeführte Abmessungen sind auf Anfrage lieferbar.

BLANKSTAHL S355J2C+C/SH H9 RUND
EN10277/EN10278/EN10025

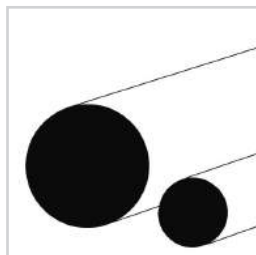

mm	3 mtr	6 mtr	kg/mtr	mm	3 mtr	6 mtr	kg/mtr
6	X	X	0,222	40	X	X	9,865
8		X	0,395	42		X	10,880
9		X	0,499	45		X	12,480
10	X	X	0,617	50		X	15,410
12		X	0,888	55		X	18,650
14		X	1,208	60		X	22,190
15		X	1,387	65		X	26,050
16		X	1,578	70		X	30,210
18		X	1,998	75		X	34,680
20		X	2,466	80		X	39,460
22		X	2,984	85		X	44,550
24		X	3,549	90		X	49,940
25		X	3,853	100	X	X	61,650
26		X	4,168	110		X	74,563
28		X	4,834	120		X	88,736
30		X	5,546	130		X	104,000
32		X	6,313	140		X	120,780
35		X	7,549				

BLANKSTAHL C35+C/SH H9 RUND
EN10277/EN10278/EN10083

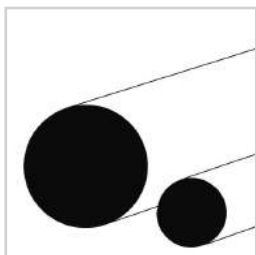

mm	3 mtr	6 mtr	kg/mtr	mm	3 mtr	6 mtr	kg/mtr
6	X		0,222	40		X	9,860
8		X	0,395	42		X	10,880
10	X	X	0,617	45		X	12,479
12		X	0,888	50		X	15,400
14		X	1,210	55		X	18,700
15		X	1,390	60		X	22,190
16		X	1,580	65		X	26,100
18		X	2,000	70		X	30,200
20		X	2,466	75		X	34,680
22		X	2,980	80		X	39,438
24		X	3,550	85		X	44,550
25		X	3,850	90		X	49,900
26		X	4,170	95		X	55,640
28		X	4,830	100		X	61,623
30		X	5,550	110		X	74,563
32		X	6,310	120		X	88,736
35		X	7,550	150		X	138,651

Wir erweitern ständig unser Lagerprogramm, nicht aufgeführte Abmessungen sind auf Anfrage lieferbar.

BLANKSTAHL C45+C/SH H9 RUND

EN10277/EN10278/EN10083

mm	3 mtr	6 mtr	kg/mtr	mm	3 mtr	6 mtr	kg/mtr
8	X	X	0,395	40		X	9,860
10		X	0,617	45		X	12,479
12		X	0,888	50		X	15,400
14		X	1,210	55		X	18,641
15		X	1,390	60		X	22,184
16		X	1,578	65		X	26,050
18		X	2,000	70		X	30,200
20		X	2,470	75		X	34,663
21	X		2,719	80		X	39,438
22		X	2,980	90		X	49,900
24		X	3,550	100		X	61,623
25		X	3,850	110		X	74,563
30		X	5,550	120		X	88,736
35		X	7,550	130		X	104,142

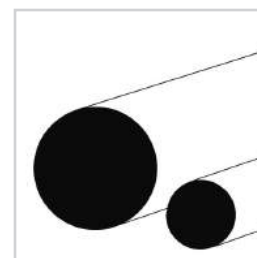
BLANKSTAHL C45+SL H6 GESCHLIFFEN RUND

EN10277/EN10278/EN10083

mm	3 mtr	6 mtr	kg/mtr	mm	3 mtr	6 mtr	kg/mtr
8	X		0,395	35		X	7,549
10		X	0,617	40		X	9,865
12		X	0,888	45		X	12,480
14		X	1,210	50		X	15,410
15		X	1,387	55		X	18,650
16		X	1,578	60		X	22,190
17		X	1,782	65		X	26,050
18		X	1,998	70		X	30,210
20		X	2,466	75		X	34,680
22		X	2,984	80		X	39,460
24		X	3,551	90		X	49,940
25		X	3,853	100		X	61,650
28		X	4,834	110		X	74,600
30		X	5,549	120		X	88,736

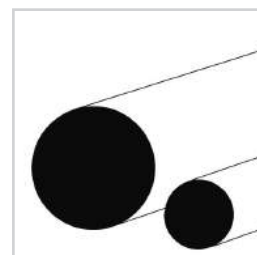

Wir erweitern ständig unser Lagerprogramm, nicht aufgeführte Abmessungen sind auf Anfrage lieferbar.

BLANKSTAHL 16MNCR5+C/SH H9 RUND
EN10277/EN10278/EN10084

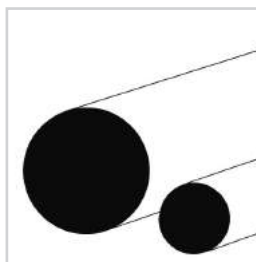

mm	3 mtr	6 mtr	kg/mtr	mm	3 mtr	6 mtr	kg/mtr
8	X		0,395	35	X		7,553
10	X		0,617	40	X		9,865
15	X		1,387	45	X		12,480
18	X		1,998	50	X		15,410
20	X		2,466	55	X		18,650
25	X		3,853	60	X		22,190
30	X		5,549	70	X		30,210

AUTOMATENSTAHL 11SMN30+C/SH H9 RUND
EN10277/EN10278/EN10087

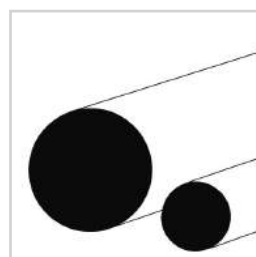

mm	3 mtr	kg/mtr	mm	3 mtr	kg/mtr
4	X	0,099	32	X	6,310
5	X	0,154	34	X	7,127
6	X	0,222	35	X	7,550
7	X	0,302	36	X	7,990
8	X	0,395	40	X	9,860
9	X	0,499	42	X	10,880
10	X	0,617	43	X	11,400
12	X	0,888	45	X	12,500
13	X	1,040	50	X	15,400
14	X	1,210	52	X	16,663
15	X	1,390	55	X	18,700
16	X	1,580	60	X	22,200
17	X	1,782	65	X	26,050
18	X	2,000	70	X	30,200
19	X	2,230	75	X	34,680
20	X	2,470	80	X	39,438
22	X	2,980	85	X	44,522
24	X	3,550	90	X	49,914
25	X	3,850	95	X	55,614
26	X	4,170	100	X	61,623
28	X	4,830	110	X	74,563
30	X	5,550	120	X	88,736

AUTOMATENSTAHL 11SMNPB30/37+C/SH H9 RUND
EN10277/EN10278/EN10087

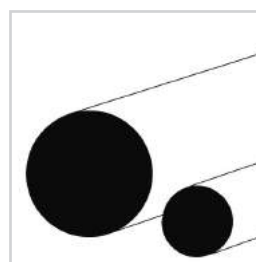

mm	3 mtr	6 mtr	kg/mtr	mm	3 mtr	6 mtr	kg/mtr
4	X		0,099	35		X	7,549
15	X		1,387	40	X		9,865
19	X		2,225	50	X		15,410
20	X		2,466	52	X		16,663
30	X		5,549	85	X		44,522

Wir erweitern ständig unser Lagerprogramm, nicht aufgeführte Abmessungen sind auf Anfrage lieferbar.

BLANKSTAHL S235JRC+C H11 VIERKANT

EN10277/EN100278/EN10025

mm	3 mtr	6 mtr	kg/mtr	mm	3 mtr	6 mtr	kg/mtr
4	X		0,126	25	X	X	4,906
5	X		0,196	28	X		6,154
6	X		0,283	30	X	X	7,065
8	X		0,502	32	X		8,038
10	X		0,785	35	X		9,616
11	X		0,950	36	X		10,174
12	X		1,130	40	X	X	12,560
13	X		1,327	45	X		15,896
14	X		1,539	50	X	X	19,625
15	X		1,766	60	X	X	28,260
16	X		2,010	70	X		38,465
17	X		2,269	80	X	X	50,240
18	X		2,543	90	X		63,585
20	X	X	3,140	100	X	X	78,500
22	X		3,799	120	X		113,040
24		X	4,522				

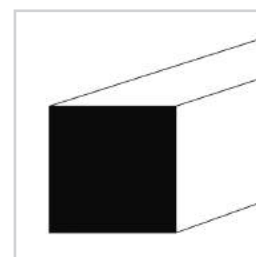

BLANKSTAHL S355J2C+C H11 VIERKANT

mm	3 mtr	6 mtr	kg/mtr	mm	mm	3 mtr	6 mtr	kg/mtr
20		X	3,140	60		X		28,260
25		X	4,906	70		X		38,460
30		X	7,065	80		X		50,240
35		X	9,616	90		X		63,585
40		X	12,560	100		X		78,500
50		X	19,625					

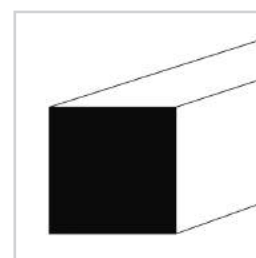

BLANKSTAHL C45+C H11 VIERKANT

EN10277/EN10278/EN10083

mm	3 mtr	6 mtr	kg/mtr	mm	3 mtr	6 mtr	kg/mtr
12	X		1,130	40	X		12,560
15	X		1,766	45	X		15,890
18	X		2,543	50	X	X	19,620
20	X		3,140	60	X	X	28,260
22	X		3,799	70		X	38,460
25	X		4,906	80	X		50,240
30		X	7,065	90	X		63,580
35	X		9,616	100	X		78,500

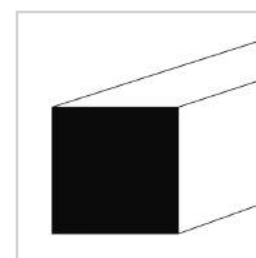

AUTOMATENSTAHL 11SMN30+C H11 SECHSKANT

EN10277/EN10278/EN10087

mm	3 mtr	6 mtr	kg/mtr	mm	3 mtr	6 mtr	kg/mtr
10	X		0,680	24	X		3,916
11	X		0,823	27	X		4,956
12	X		0,979	30	X		6,118
13	X		1,149	36	X		8,811
17	X		1,965	55	X		20,565
19	X		2,454				

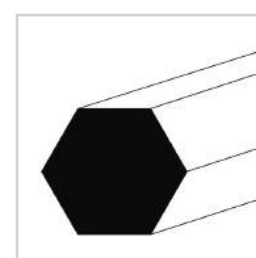

Wir erweitern ständig unser Lagerprogramm, nicht aufgeführte Abmessungen sind auf Anfrage lieferbar.

AUTOMATENSTAHL 11SMNPB30/37+C H11 SECHSKANT
EN10277/EN10278/EN10087

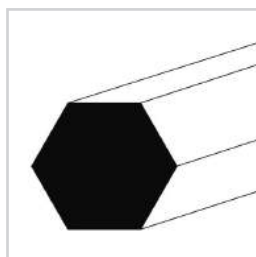

mm	3 mtr	6 mtr	kg/mtr	mm	3 mtr	6 mtr	kg/mtr
8	X		0,435	24	X		3,916
9	X		0,551	27	X		4,956
13	X		1,149	30	X		6,118
14	X		1,330	32	X		6,961
17	X		1,965	36	X		8,811
19	X		2,454	41	X		11,428
22	X		3,290	46	X		14,385

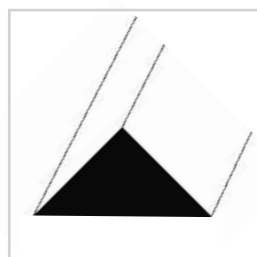

BLANKSTAHL S235JRC+C DREIKANT
EN10277/EN 10278/EN 10025

mm	mm	mm	3 mtr	6 mtr	kg/mtr	mm	mm	mm	3 mtr	6 mtr	kg/mtr
10	10	10	X		0,350	15	15	21,15	X		0,900
10	10	14,1	X		0,400	20	20	28,30	X		1,570

BLANKSTAHL S235JRC+C GLEICHSCH. WINKEL
DIN 59370/EN10025

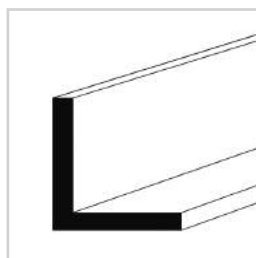

mm	mm	mm	3 mtr	6 mtr	kg/mtr	mm	mm	mm	3 mtr	6 mtr	kg/mtr
10	10	2	X		0,280	30	30	5	X		2,180
12	12	2	X		0,380	35	35	3	X		1,600
12	12	3	X		0,570	35	35	4	X		2,100
15	15	2	X		0,490	35	35	5	X		2,570
15	15	3	X		0,620	40	40	3	X		1,820
20	20	2	X		0,590	40	40	4	X		2,420
20	20	3	X		0,880	40	40	5	X		2,970
20	20	4	X		1,140	40	40	6	X		3,520
25	25	2	X		0,750	45	45	5	X		3,380
25	25	3	X		1,120	50	50	5	X		3,770
25	25	4	X		1,450	50	50	6	X		4,470
25	25	5	X		1,770	60	60	6	X	X	5,420
30	30	2	X		0,950	80	80	8	X	X	9,660
30	30	3	X		1,360	100	100	10	X	X	15,100
30	30	4	X		1,780						

BLANKSTAHL S235JRC+C UNGLEICHSCH. WINKEL
DIN 59370/EN10025

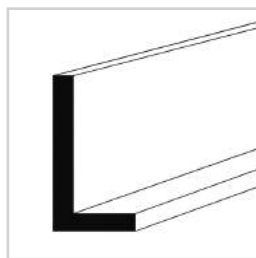

mm	mm	mm	3 mtr	6 mtr	kg/mtr	mm	mm	mm	3 mtr	6 mtr	kg/mtr
20	10	3	X		0,640	45	30	4	X		2,250
20	15	3	X		0,740	45	30	5	X		2,770
20	15	4	X		0,900	50	30	5	X		2,960
25	15	3	X		0,870	60	30	5	X		3,370
30	20	3	X		1,110	60	40	5	X		3,760
30	20	4	X		1,450	80	40	6	X		5,410
40	20	3	X		1,350	100	50	10	X	X	11,100
40	20	4	X		1,770	130	65	10		X	14,600
40	20	5	X		2,100	150	75	12		X	22,000
40	30	3	X		1,650						

Wir erweitern ständig unser Lagerprogramm, nicht aufgeführte Abmessungen sind auf Anfrage lieferbar.

BLANKER KEILSTAHL C45+C H9/H11 FLACH
DIN 6680/EN10083

mm	mm	3 mtr	kg/mtr	mm	mm	3 mtr	kg/mtr
8	7	X	0,440	20	12	X	1,884
10	6	X	0,470	22	14	X	2,418
10	8	X	0,630	25	14	X	2,750
12	8	X	0,754	28	16	X	3,520
12	10	X	0,940	32	18	X	4,520
14	9	X	0,990	36	20	X	5,650
16	10	X	1,260	40	22	X	6,910
18	11	X	1,554				

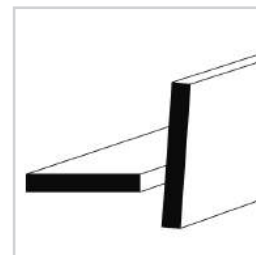
BLANKER KEILSTAHL C45+C H11 VIERKANT
DIN 6680/EN10083

mm	3 mtr	kg/mtr	mm	3 mtr	kg/mtr
5	X	0,196	12	X	1,130
6	X	0,283	14	X	1,539
8	X	0,502	16	X	2,010
10	X	0,785			

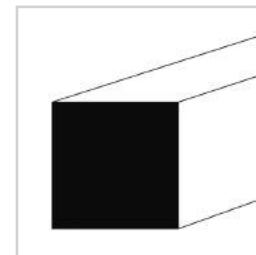

SILBERSTAHL 115CRV3 RUND
EN10278/ISO 4957

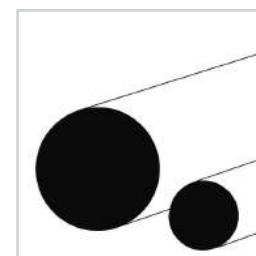
mm	2 mtr	kg/mtr	mm	2 mtr	kg/mtr
2	X	0,025	14	X	1,208
2,5	X	0,039	15	X	1,387
3	X	0,055	16	X	1,578
4	X	0,099	17	X	1,782
5	X	0,154	18	X	1,998
6	X	0,222	20	X	2,466
7	X	0,302	22	X	2,984
8	X	0,395	24	X	3,551
9	X	0,499	25	X	3,853
10	X	0,617	30	X	5,550
11	X	0,746	35	X	7,550
12	X	0,888	40	X	9,860
13	X	1,042	50	X	15,400

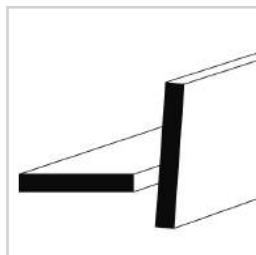

Wir erweitern ständig unser Lagerprogramm, nicht aufgeführte Abmessungen sind auf Anfrage lieferbar.

■ EDELSTAHL 1.4301 VOM BAND FLACH, HL 4 / 6 MTR
EN10058/EN10088



mm	mm	4 mtr	6 mtr	kg/mtr	mm	mm	4 mtr	6 mtr	kg/mtr
10,0	3,0	X		0,240	50,0	8,0		X	3,140
15,0	3,0	X		0,353	50,0	10,0		X	3,930
15,0	4,0	X		0,471	50,0	12,0		X	4,710
15,0	5,0	X		0,589	60,0	4,0		X	1,884
15,0	6,0	X		0,707	60,0	5,0		X	2,360
20,0	3,0		X	0,471	60,0	6,0		X	2,830
20,0	4,0		X	0,628	60,0	8,0		X	3,770
20,0	5,0		X	0,785	60,0	10,0		X	4,710
20,0	6,0		X	0,942	60,0	12,0		X	5,700
20,0	8,0		X	1,260	70,0	5,0		X	2,750
20,0	10,0		X	1,570	70,0	6,0		X	3,300
25,0	3,0		X	0,589	70,0	8,0		X	4,400
25,0	4,0		X	0,785	70,0	10,0		X	5,500
25,0	5,0		X	0,981	80,0	5,0		X	3,140
25,0	6,0		X	1,178	80,0	6,0		X	3,770
25,0	8,0		X	1,570	80,0	8,0		X	5,020
25,0	10,0		X	1,963	80,0	10,0		X	6,280
30,0	3,0		X	0,710	80,0	12,0		X	7,540
30,0	4,0		X	0,942	100,0	5,0		X	3,930
30,0	5,0		X	1,177	100,0	6,0		X	4,710
30,0	6,0		X	1,413	100,0	8,0		X	6,280
30,0	8,0		X	1,884	100,0	10,0		X	7,850
30,0	10,0		X	2,355	100,0	12,0		X	11,300
35,0	4,0		X	1,100	120,0	5,0		X	4,710
35,0	5,0		X	1,370	120,0	6,0		X	5,650
35,0	6,0		X	1,650	120,0	8,0		X	7,450
35,0	8,0		X	2,200	120,0	10,0		X	9,420
35,0	10,0		X	2,750	120,0	12,0		X	11,300
40,0	3,0		X	0,942	140,0	8,0		X	8,950
40,0	4,0		X	1,260	140,0	10,0		X	11,200
40,0	5,0		X	1,570	150,0	6,0		X	7,200
40,0	6,0		X	1,880	150,0	8,0		X	9,600
40,0	8,0		X	2,510	150,0	10,0		X	12,000
40,0	10,0		X	3,140	160,0	10,0		X	12,560
50,0	3,0		X	1,180	180,0	10,0		X	14,130
50,0	4,0		X	1,570	200,0	8,0		X	12,560
50,0	5,0		X	1,960	200,0	10,0		X	15,700
50,0	6,0		X	2,360	200,0	12,0		X	18,840

Wir erweitern ständig unser Lagerprogramm, nicht aufgeführte Abmessungen sind auf Anfrage lieferbar.

■ EDELSTAHL 1.4301 GEWALZT FLACH, HL 6 MTR
EN10058/EN10088

mm	mm	6 mtr	kg/mtr
20,0	12,0	X	1,880
20,0	15,0	X	2,360
25,0	12,0	X	2,355
25,0	15,0	X	2,940
25,0	20,0	X	4,000
30,0	12,0	X	2,826
30,0	15,0	X	3,532
30,0	20,0	X	4,710
30,0	25,0	X	5,900
40,0	12,0	X	3,770
40,0	15,0	X	4,710
40,0	20,0	X	6,280
40,0	25,0	X	7,850
40,0	30,0	X	9,420
50,0	15,0	X	5,890
50,0	20,0	X	7,850
50,0	25,0	X	9,810

mm	mm	6 mtr	kg/mtr
50,0	30,0	X	11,800
60,0	15,0	X	7,070
60,0	20,0	X	9,420
60,0	30,0	X	14,100
60,0	40,0	X	18,840
80,0	15,0	X	9,420
80,0	20,0	X	12,600
80,0	30,0	X	18,800
80,0	40,0	X	25,120
100,0	15,0	X	11,800
100,0	20,0	X	15,700
100,0	25,0	X	19,600
100,0	30,0	X	23,600
100,0	40,0	X	31,400
120,0	15,0	X	14,100
120,0	20,0	X	18,800

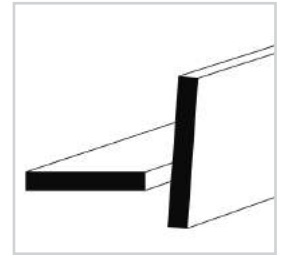

■ EDELSTAHL 1.4301 GESCHLIFFEN K240 FLACH, HL 4 / 6 MTR
EN10058/EN10088

mm	mm	4 mtr	6 mtr	kg/mtr
20,0	5,0		X	0,790
20,0	6,0		X	0,940
20,0	8,0		X	1,260
20,0	10,0		X	1,570
25,0	5,0		X	0,980
25,0	6,0		X	1,180
25,0	8,0		X	1,570
25,0	10,0		X	1,960
30,0	4,0		X	0,942
30,0	5,0		X	1,180
30,0	6,0		X	1,413
30,0	8,0		X	1,884
30,0	10,0		X	2,360
30,0	12,0		X	2,830
40,0	4,0		X	1,260
40,0	5,0		X	1,570
40,0	6,0		X	1,880
40,0	8,0		X	2,510
40,0	10,0		X	3,140
40,0	12,0		X	3,770
40,0	15,0		X	4,710
50,0	5,0		X	1,960
50,0	6,0		X	2,360
50,0	8,0		X	3,140

mm	mm	4 mtr	6 mtr	kg/mtr
50,0	10,0		X	3,930
50,0	12,0		X	4,710
50,0	15,0		X	5,890
60,0	5,0		X	2,360
60,0	6,0		X	2,830
60,0	8,0		X	3,770
60,0	10,0		X	4,720
60,0	12,0		X	5,650
60,0	15,0		X	7,070
80,0	5,0		X	3,140
80,0	6,0		X	3,770
80,0	8,0		X	5,020
80,0	10,0		X	6,300
100,0	5,0		X	3,930
100,0	6,0		X	4,710
100,0	8,0		X	6,280
100,0	10,0		X	7,850
120,0	8,0		X	7,450
120,0	10,0		X	9,420
140,0	8,0		X	8,900
140,0	10,0		X	11,200
150,0	8,0		X	9,600
150,0	10,0		X	12,000

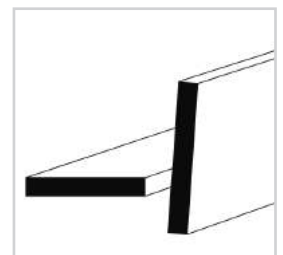

Wir erweitern ständig unser Lagerprogramm, nicht aufgeführte Abmessungen sind auf Anfrage lieferbar.

■ EDELSTAHL 1.4301 GEZOGEN FLACH
EN10278/EN10088

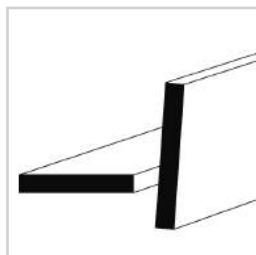

mm	mm	3 mtr	kg/mtr	mm	mm	3 mtr	kg/mtr
10,0	5,0	X	0,400	50,0	6,0	X	2,360
15,0	6,0	X	0,707	50,0	8,0	X	3,140
15,0	8,0	X	0,960	50,0	10,0	X	3,930
15,0	10,0	X	1,180	50,0	12,0	X	4,710
15,0	12,0	X	1,413	50,0	15,0	X	5,890
20,0	5,0	X	0,790	50,0	20,0	X	7,850
20,0	6,0	X	0,940	50,0	25,0	X	9,810
20,0	8,0	X	1,260	50,0	30,0	X	11,800
20,0	10,0	X	1,570	60,0	5,0	X	2,360
20,0	12,0	X	1,880	60,0	6,0	X	2,830
20,0	15,0	X	2,360	60,0	8,0	X	3,770
25,0	5,0	X	0,980	60,0	10,0	X	4,710
25,0	6,0	X	1,180	60,0	12,0	X	5,650
25,0	8,0	X	1,570	60,0	15,0	X	7,070
25,0	10,0	X	1,960	60,0	20,0	X	9,420
25,0	12,0	X	2,360	60,0	25,0	X	11,780
25,0	15,0	X	2,940	60,0	30,0	X	14,100
25,0	20,0	X	3,930	60,0	40,0	X	18,840
30,0	5,0	X	1,180	70,0	8,0	X	4,400
30,0	6,0	X	1,410	80,0	5,0	X	3,140
30,0	8,0	X	1,880	80,0	6,0	X	3,770
30,0	10,0	X	2,360	80,0	8,0	X	5,020
30,0	12,0	X	2,830	80,0	10,0	X	6,280
30,0	15,0	X	3,532	80,0	15,0	X	9,420
30,0	20,0	X	4,710	80,0	20,0	X	12,560
30,0	25,0	X	5,890	80,0	30,0	X	18,800
40,0	5,0	X	1,570	80,0	40,0	X	25,120
40,0	6,0	X	1,880	100,0	5,0	X	3,930
40,0	8,0	X	2,510	100,0	6,0	X	4,710
40,0	10,0	X	3,140	100,0	8,0	X	6,280
40,0	12,0	X	3,770	100,0	10,0	X	7,850
40,0	15,0	X	4,710	100,0	12,0	X	9,420
40,0	20,0	X	6,280	100,0	15,0	X	11,780
40,0	25,0	X	7,850	100,0	20,0	X	15,700
40,0	30,0	X	9,420	100,0	30,0	X	23,600
50,0	5,0	X	1,960				

Wir erweitern ständig unser Lagerprogramm, nicht aufgeführte Abmessungen sind auf Anfrage lieferbar.

■ EDELSTAHL 1.4301 GEZOGEN RUND
EN10278/EN10088

mm	3 mtr	6 mtr	kg/mtr	mm	3 mtr	6 mtr	kg/mtr
2,0	X		0,030	28,0	X		4,834
3,0	X		0,055	30,0	X		5,549
4,0	X		0,099	32,0	X		6,310
5,0	X		0,154	33,0	X		6,710
6,0	X		0,222	35,0	X		7,553
8,0	X	X	0,400	40,0	X		9,865
10,0	X	X	0,617	42,0	X		10,880
12,0	X	X	0,888	45,0	X		12,490
14,0	X	X	1,208	50,0	X		15,414
15,0	X	X	1,387	55,0	X		18,700
16,0	X	X	1,580	60,0	X		22,195
18,0	X		1,998	65,0	X		26,100
20,0	X	X	2,470	70,0	X		30,210
22,0	X		2,984	80,0	X		39,500
24,0	X		3,551	90,0	X		49,940
25,0	X	X	3,853	100,0	X		62,800
26,0	X		4,170				

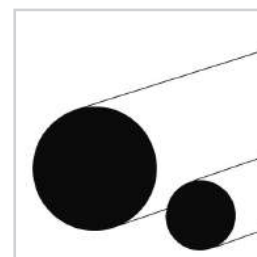

■ EDELSTAHL 1.4301 GEWALZT RUND
EN10060/EN10088

mm	6 mtr	kg/mtr	mm	6 mtr	kg/mtr
80,0	X	39,500	140,0	X	121,000
90,0	X	49,940	150,0	X	139,000
100,0	X	62,800	160,0	X	161,000
120,0	X	88,800	180,0	X	200,000
125,0	X	96,000	200,0	X	251,000
130,0	X	104,000			

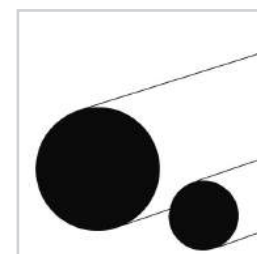

■ EDELSTAHL 1.4301 GESCHLIFFEN K240 RUND

mm	3 mtr	6 mtr	kg/mtr	mm	3 mtr	6 mtr	kg/mtr
8,0	X	X	0,400	15,0	X	X	1,387
10,0	X	X	0,617	16,0	X	X	1,578
12,0	X	X	0,888	20,0	X	X	2,470
14,0	X	X	1,208				

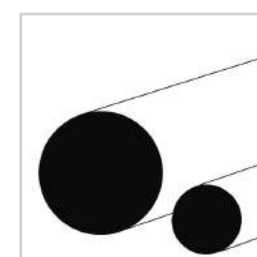

Wir erweitern ständig unser Lagerprogramm, nicht aufgeführte Abmessungen sind auf Anfrage lieferbar.

EDELSTAHL 1.4305 GEZOGEN RUND
EN10278/EN10088

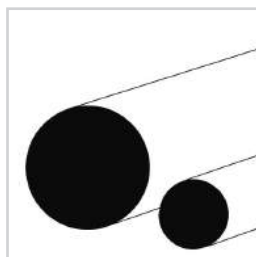

mm	3 mtr	kg/mtr	mm	3 mtr	kg/mtr
5,0	X	0,154	28,0	X	4,834
6,0	X	0,222	30,0	X	5,550
8,0	X	0,400	32,0	X	6,310
10,0	X	0,620	35,0	X	7,550
12,0	X	0,890	40,0	X	9,870
14,0	X	1,208	45,0	X	12,490
15,0	X	1,390	50,0	X	15,700
16,0	X	1,580	55,0	X	18,650
18,0	X	2,000	60,0	X	22,200
20,0	X	2,470	70,0	X	30,210
22,0	X	2,984	80,0	X	39,460
24,0	X	3,551	90,0	X	49,940
25,0	X	3,850	100,0	X	62,800
26,0	X	4,170			

EDELSTAHL 1.4571 GEZOGEN RUND
EN10278/EN10088

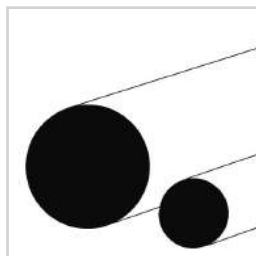

mm	3 mtr	kg/mtr	mm	3 mtr	kg/mtr
8,0	X	0,400	30,0	X	5,549
10,0	X	0,620	35,0	X	7,553
12,0	X	0,890	40,0	X	9,870
15,0	X	1,390	45,0	X	12,490
16,0	X	1,580	50,0	X	15,700
18,0	X	2,000	60,0	X	22,200
20,0	X	2,470	70,0	X	30,210
25,0	X	3,850	80,0	X	39,500

EDELSTAHL 1.4301 GEZOGEN VIERKANT
EN10278/EN10088

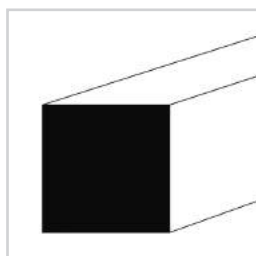

mm	3 mtr	kg/mtr	mm	3 mtr	kg/mtr
6,0	X	0,283	20,0	X	3,140
8,0	X	0,502	25,0	X	5,200
10,0	X	0,785	30,0	X	7,070
12,0	X	1,130	35,0	X	9,620
14,0	X	1,540	40,0	X	12,560
15,0	X	1,766	50,0	X	20,000
16,0	X	2,010	60,0	X	28,800

EDELSTAHL 1.4301 GEZOGEN + GESCHLIFFEN VIERKANT K240

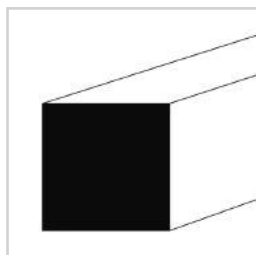

mm	3 mtr	kg/mtr	mm	3 mtr	kg/mtr
10,0	X	0,790	15,0	X	1,770
12,0	X	1,130	20,0	X	3,140

Wir erweitern ständig unser Lagerprogramm, nicht aufgeführte Abmessungen sind auf Anfrage lieferbar.

EDELSTAHL 1.4305 GEZOGEN VIERKANT
EN10278/EN10088

mm	3 mtr	kg/mtr	mm	3 mtr	kg/mtr
10,0	X	0,785	25,0	X	5,200
12,0	X	1,130	30,0	X	7,070
15,0	X	1,766	40,0	X	12,560
20,0	X	3,140			

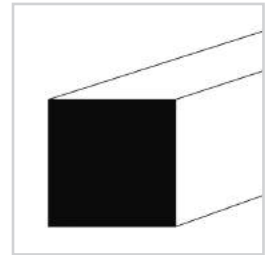

EDELSTAHL 1.4301 GEZOGEN SECHSKANT
EN10278/EN10088

mm	3 mtr	kg/mtr	mm	3 mtr	kg/mtr
8,0	X	0,450	17,0	X	1,970
10,0	X	0,683	19,0	X	2,480
12,0	X	0,980	22,0	X	3,290
13,0	X	1,150	24,0	X	3,940
14,0	X	1,330	27,0	X	4,960

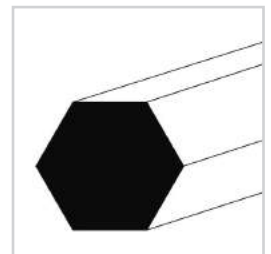

EDELSTAHL 1.4301 GEWALZT U-PROFIL
DIN 1026/EN10088

mm	mm	mm	mm	6 mtr	kg/mtr	mm	mm	mm	mm	6 mtr	kg/mtr
40,0	20,0	3	3	X	1,800	100,0	50,0	6	6	X	8,940
60,0	30,0	6	6	X	5,100	150,0	75,0	9	9	X	20,000
80,0	40,0	5	5	X	5,940						

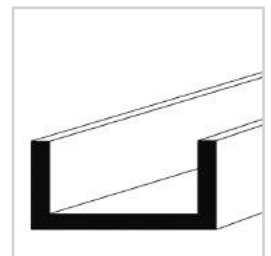

EDELSTAHL 1.4301 WARMGEWALZT WINKEL GLEICHSCH.
DIN 1028/EN10088

mm	mm	mm	6 mtr	kg/mtr	mm	mm	mm	6 mtr	kg/mtr
15,0	15,0	3	X	0,707	45,0	45,0	5	X	3,340
20,0	20,0	3	X	0,880	50,0	50,0	5	X	3,770
25,0	25,0	3	X	1,120	50,0	50,0	6	X	4,470
30,0	30,0	3	X	1,360	60,0	60,0	6	X	5,420
30,0	30,0	4	X	1,780	70,0	70,0	7	X	7,470
35,0	35,0	4	X	2,100	80,0	80,0	8	X	9,660
40,0	40,0	4	X	2,420	100,0	100,0	10	X	15,100
40,0	40,0	5	X	2,970					

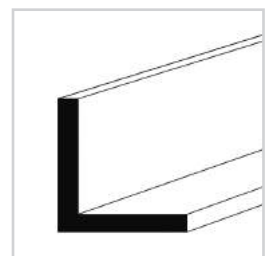

EDELSTAHL 1.4301 WARMGEWALZT WINKEL UNGLEICHSCH.
DIN 1028/EN10088

mm	mm	mm	6 mtr	kg/mtr	mm	mm	mm	6 mtr	kg/mtr
40,0	20,0	4	X	1,800	60,0	40,0	5	X	3,730
50,0	30,0	5	X	2,950	80,0	40,0	6	X	5,410
60,0	30,0	5	X	3,370	100,0	50,0	6	X	6,800

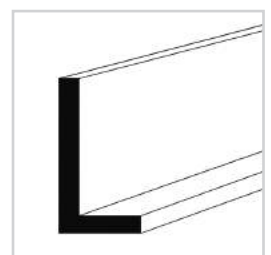

Wir erweitern ständig unser Lagerprogramm, nicht aufgeführte Abmessungen sind auf Anfrage lieferbar.

EDELSTAHL 1.4301 WARMGEWALZT WINKEL GESCHL. K240
DIN 1028/EN10088

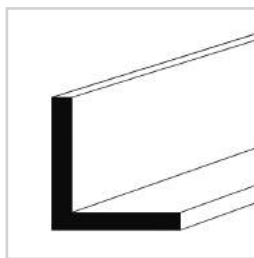

mm	mm	mm	6 mtr	kg/mtr
25,0	25,0	3	X	1,120
30,0	30,0	3	X	1,360
40,0	40,0	4	X	2,420
50,0	50,0	5	X	3,770
60,0	60,0	6	X	5,420

EDELSTAHL 1.4301 QUADRATROHR ROH
EN10088

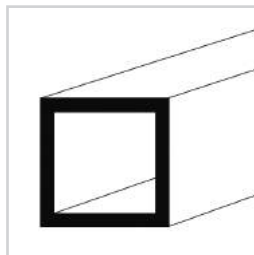

mm	mm	mm	6 mtr	kg/mtr	mm	mm	mm	6 mtr	kg/mtr
15,0	15,0	1,5	X	0,676	60,0	60,0	3	X	5,634
20,0	20,0	2	X	1,202	60,0	60,0	4	X	7,412
25,0	25,0	2	X	1,527	60,0	60,0	5	X	9,140
30,0	30,0	2	X	1,853	70,0	70,0	3	X	6,611
30,0	30,0	3	X	2,704	80,0	80,0	2	X	5,108
35,0	35,0	2	X	2,178	80,0	80,0	3	X	7,587
40,0	40,0	2	X	2,504	80,0	80,0	4	X	10,016
40,0	40,0	3	X	3,681	80,0	80,0	5	X	12,395
40,0	40,0	4	X	4,808	100,0	100,0	2	X	6,410
45,0	45,0	2	X	2,830	100,0	100,0	3	X	9,540
50,0	50,0	2	X	3,155	100,0	100,0	4	X	12,620
50,0	50,0	3	X	4,657	100,0	100,0	5	X	15,650
50,0	50,0	4	X	6,110	120,0	120,0	3	X	11,493
50,0	50,0	5	X	7,512	120,0	120,0	4	X	15,224
60,0	60,0	2	X	3,806					

EDELSTAHL 1.4301 QUADRATROHR GESCHLIFFEN K240
EN10088

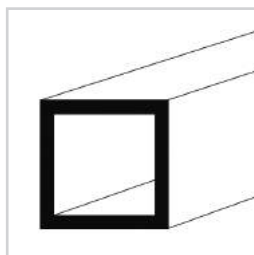

mm	mm	mm	6 mtr	kg/mtr	mm	mm	mm	6 mtr	kg/mtr
15,0	15,0	1,5	X	0,676	60,0	60,0	2	X	3,800
20,0	20,0	2	X	1,200	60,0	60,0	3	X	5,634
25,0	25,0	2	X	1,527	60,0	60,0	4	X	7,412
30,0	30,0	2	X	1,853	80,0	80,0	2	X	5,108
30,0	30,0	3	X	2,704	80,0	80,0	3	X	7,587
35,0	35,0	2	X	2,178	100,0	100,0	2	X	6,410
40,0	40,0	2	X	2,504	100,0	100,0	3	X	9,540
40,0	40,0	3	X	3,681	100,0	100,0	4	X	12,620
50,0	50,0	2	X	3,160	120,0	120,0	3	X	11,500
50,0	50,0	3	X	4,657					

Wir erweitern ständig unser Lagerprogramm, nicht aufgeführte Abmessungen sind auf Anfrage lieferbar.

■ EDELSTAHL 1.4301 RECHTECKROHR ROH
EN 10088

mm	mm	mm	6 mtr	kg/mtr	mm	mm	mm	6 mtr	kg/mtr
20,0	10,0	1,5	X	0,676	60,0	40,0	3	X	4,657
25,0	10,0	1,5	X	0,798	60,0	40,0	4	X	6,110
25,0	15,0	1,5	X	0,920	80,0	20,0	2	X	3,155
30,0	10,0	1,5	X	0,920	80,0	40,0	2	X	3,806
30,0	15,0	1,5	X	1,042	80,0	40,0	3	X	5,634
30,0	15,0	2	X	1,365	80,0	40,0	4	X	7,412
30,0	20,0	2	X	1,527	80,0	50,0	3	X	6,122
40,0	15,0	1,5	X	1,286	80,0	60,0	3	X	6,611
40,0	20,0	2	X	1,853	100,0	40,0	2	X	4,457
40,0	30,0	2	X	2,178	100,0	40,0	3	X	6,611
50,0	20,0	2	X	2,178	100,0	50,0	2	X	4,783
50,0	25,0	2	X	2,341	100,0	50,0	3	X	7,099
50,0	30,0	2	X	2,504	100,0	50,0	4	X	9,365
50,0	30,0	3	X	3,681	100,0	60,0	3	X	7,587
50,0	40,0	2	X	2,830	100,0	60,0	4	X	10,016
60,0	20,0	2	X	2,504	120,0	40,0	2	X	5,108
60,0	30,0	2	X	2,830	120,0	40,0	3	X	7,587
60,0	30,0	3	X	4,169	120,0	60,0	3	X	8,564
60,0	40,0	2	X	3,155	120,0	60,0	4	X	11,318

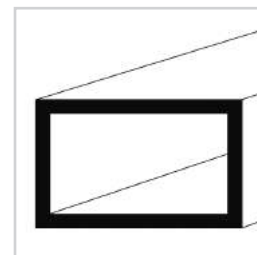

■ EDELSTAHL 1.4301 RECHTECKROHR GESCHLIFFEN K240
EN ISO 1127/EN10088

mm	mm	mm	6 mtr	kg/mtr	mm	mm	mm	6 mtr	kg/mtr
30,0	15,0	1,5	X	1,042	60,0	40,0	2	X	3,155
30,0	15,0	2	X	1,365	60,0	40,0	3	X	4,657
30,0	20,0	2	X	1,527	80,0	40,0	2	X	3,806
40,0	15,0	1,5	X	1,286	80,0	40,0	3	X	5,634
40,0	20,0	2	X	1,853	80,0	50,0	3	X	6,120
40,0	30,0	2	X	2,178	80,0	60,0	3	X	6,611
50,0	20,0	2	X	2,178	100,0	40,0	2	X	4,457
50,0	30,0	2	X	2,504	100,0	40,0	3	X	6,611
50,0	30,0	3	X	3,681	100,0	50,0	2	X	4,783
60,0	20,0	2	X	2,504	100,0	50,0	3	X	7,099
60,0	30,0	2	X	2,830	100,0	60,0	3	X	7,587
60,0	30,0	3	X	4,169	120,0	60,0	3	X	8,564

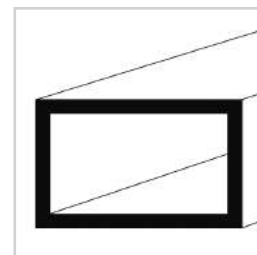

■ EDELSTAHL 1.4301 RUNDROHR GESCHLIFFEN K240 + GEGLÜHT
EN10217/EN10088

mm	mm	6 mtr	kg/mtr
26,9	2,0	X	1,247
33,7	2,0	X	1,588
42,4	2,0	X	2,030

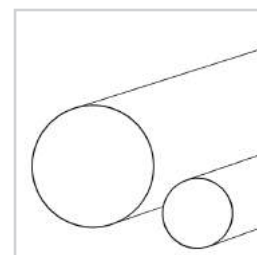

Wir erweitern ständig unser Lagerprogramm, nicht aufgeführte Abmessungen sind auf Anfrage lieferbar.

■ EDELSTAHL 1.4301 RUNDROHR HF/TIG GESCHW. ROH
EN ISO 1127/EN10088

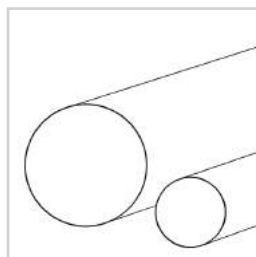

mm	mm	6 mtr	kg/mtr	mm	mm	6 mtr	kg/mtr
6,0	1,0	X	0,130	60,3	2,5	X	3,620
8,0	1,0	X	0,175	60,3	3,0	X	4,300
20,0	2,0	X	0,900	60,3	4,0	X	5,639
21,3	2,0	X	0,967	70,0	2,0	X	3,405
21,3	2,5	X	1,177	76,1	2,0	X	3,711
25,0	2,0	X	1,160	76,1	3,0	X	5,490
26,9	2,0	X	1,247	80,0	2,0	X	3,906
26,9	2,5	X	1,527	88,9	2,0	X	4,352
30,0	2,0	X	1,402	88,9	3,0	X	6,453
30,0	3,0	X	2,030	101,6	2,0	X	4,988
33,7	2,0	X	1,588	101,6	3,0	X	7,407
33,7	2,5	X	2,025	101,6	4,0	X	9,810
33,7	3,0	X	2,306	104,0	2,0	X	5,108
40,0	2,0	X	1,903	108,0	2,0	X	5,330
40,0	3,0	X	2,779	114,3	2,0	X	5,624
42,4	2,0	X	2,023	114,3	3,0	X	8,361
42,4	2,5	X	2,591	139,7	2,0	X	6,896
42,4	3,0	X	3,141	139,7	3,0	X	10,269
48,3	2,0	X	2,319	154,0	2,0	X	7,612
48,3	2,5	X	2,975	168,3	2,0	X	8,328
48,3	3,0	X	3,403	168,3	3,0	X	12,417
50,0	2,0	X	2,404	204,0	2,0	X	10,150
54,0	2,0	X	2,604	219,1	3,0	X	16,233
60,3	2,0	X	2,920				

■ EDELSTAHL 1.4301 RUNDROHR HF GESCHW. + GESCHL. K240
EN ISO 1127/EN10088

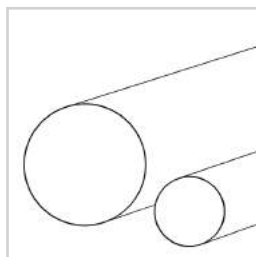

mm	mm	6 mtr	kg/mtr	mm	mm	6 mtr	kg/mtr
10,0	1,5	X	0,319	40,0	2,0	X	1,903
12,0	1,5	X	0,394	42,4	2,0	X	2,030
14,0	1,5	X	0,470	42,4	2,5	X	2,498
15,0	1,5	X	0,509	42,4	3,0	X	2,960
16,0	1,0	X	0,370	48,3	2,0	X	2,319
16,0	1,5	X	0,545	48,3	2,5	X	2,867
16,0	2,0	X	0,701	48,3	3,0	X	3,403
17,2	2,0	X	0,761	50,0	2,0	X	2,404
18,0	1,5	X	0,620	54,0	2,0	X	2,600
20,0	1,5	X	0,695	60,3	2,0	X	2,920
20,0	2,0	X	0,901	60,3	3,0	X	4,300
21,3	2,0	X	0,967	70,0	2,0	X	3,420
25,0	2,0	X	1,152	76,1	2,0	X	3,711
26,9	2,0	X	1,247	76,1	3,0	X	5,490
26,9	2,5	X	1,527	88,9	2,0	X	4,352
30,0	2,0	X	1,402	88,9	3,0	X	6,453
33,7	2,0	X	1,588	101,6	2,0	X	4,988
33,7	2,5	X	1,953	101,6	3,0	X	7,407
33,7	3,0	X	2,306	101,6	4,0	X	9,810
35,0	2,0	X	1,653	114,3	2,0	X	5,624
38,0	2,0	X	1,803	114,3	3,0	X	8,361

Wir erweitern ständig unser Lagerprogramm, nicht aufgeführte Abmessungen sind auf Anfrage lieferbar.

■ EDELSTAHLBLECH 1.4301 2B (IIIC)

EN10028/EN10088

Stärke mm	1000 x 2000 mm kg/Tfl.	1250 x 2500 mm kg/Tfl.	1500 x 3000 mm kg/Tfl.
0,5	8,000		
0,6	9,600	15,000	
0,7	11,200		
0,8	12,800	20,000	28,800
1,0	16,000	25,000	36,000
1,2	20,000	31,500	45,000
1,5	24,000	38,000	54,000
2,0	32,000	50,000	72,000
2,5	40,000	62,500	90,000
3,0	48,000	75,000	108,000
4,0	64,000	100,000	144,000
5,0	80,000	125,000	180,000
6,0	96,000	150,000	216,000

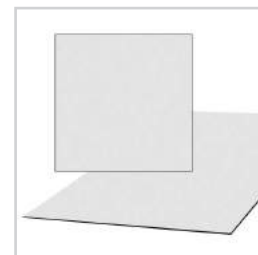

■ EDELSTAHLBLECH 1.4301 2B (IIIC) EINSEITIG FOLIERT

EN10028/EN10088

Stärke mm	1000 x 2000 mm kg/Tfl.	1250 x 2500 mm kg/Tfl.	1500 x 3000 mm kg/Tfl.
1,0	16,000	25,000	36,000
1,5	24,000	37,500	54,000
2,0	32,000	50,000	72,000
3,0	48,000	75,000	108,000

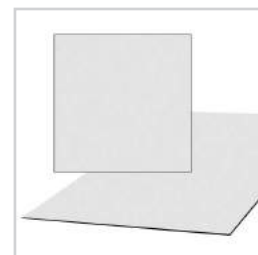

■ EDELSTAHLBLECH 1.4301 2B (IIIC)

EINSEITIG GESCHLIFFEN K240 + FOLIERT

EN10028/EN10088

Stärke mm	1000 x 2000 mm kg/Tfl.	1250 x 2500 mm kg/Tfl.	1500 x 3000 mm kg/Tfl.
0,8	12,800	20,000	
1,0	16,000	25,000	36,000
1,5	24,000	37,500	54,000
2,0	32,000	50,000	72,000
3,0	48,000	75,000	108,000
4,0	64,000	100,000	144,000
5,0	80,000	125,000	180,000

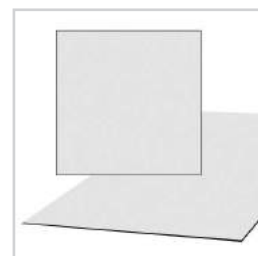

■ EDELSTAHLBLECH 1.4301 2B (IIIC)

EINSEITIG GEBÜRSTET K240 + FOLIERT (DUPLOSCHLIFF)

EN10028/EN10088

Stärke mm	1000 x 2000 mm kg/Tfl.	1250 x 2500 mm kg/Tfl.	1500 x 3000 mm kg/Tfl.
0,8	12,800	20,000	
1,0	16,000	25,000	36,000
1,5	24,000	37,500	54,000
2,0	32,000	50,000	72,000
3,0	48,000	75,000	108,000

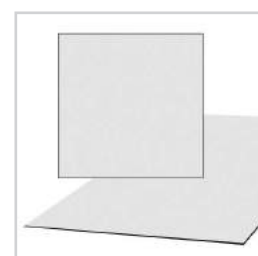

Wir erweitern ständig unser Lagerprogramm, nicht aufgeführte Abmessungen sind auf Anfrage lieferbar.

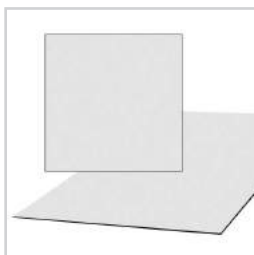

EDELSTAHLBLECH 1.4301 1D (IIA)
EN10028/EN10088

Stärke mm	1000 x 2000 mm kg/Tfl.	1250 x 2500 mm kg/Tfl.	1500 x 3000 mm kg/Tfl.
3,0	48,000	75,000	108,000
4,0	64,000	100,000	144,000
5,0	80,000	125,000	182,000
6,0	96,000	152,000	216,000
8,0	128,000	200,000	292,000
10,0	160,000	253,000	360,000
12,0	202,000	310,000	443,000
15,0	245,000	390,000	545,000
20,0	320,000	517,000	740,000

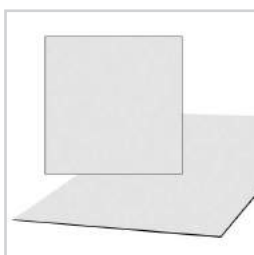

EDELSTAHLBLECH 1.4571 2B (IIIC)
EN10028/EN10088

Stärke mm	1000 x 2000 mm kg/Tfl.	1250 x 2500 mm kg/Tfl.	1500 x 3000 mm kg/Tfl.
1,0	16,000	25,000	36,000
1,5	24,000	37,500	54,000
2,0	32,000	50,000	72,000
3,0	48,000	75,000	108,000
4,0	64,000	100,000	144,000
5,0	80,000	125,000	180,000

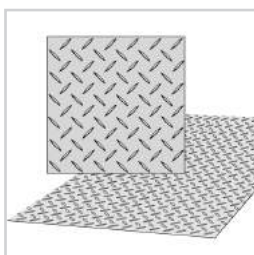

EDELSTAHL 1.4301 TRÄNENBLECH „MANDORLA“
EN10204/EN10088

Stärke mm	1000 x 2000 mm kg/Tfl.	1250 x 2500 mm kg/Tfl.	1500 x 3000 mm kg/Tfl.	1250 x 3000 mm kg/Tfl.
3,0	54,000	86,000	135,000	102,000
4,0	70,000	113,000	169,000	
5,0	84,000	131,000	199,000	
6,0	105,000	155,000	235,000	

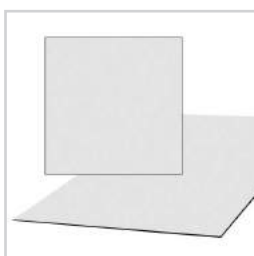

EDELSTAHLBLECH 1.4301 2B (IIIC)
BEIDSEITIG GEBÜRSTET+ FOLIERT (DUPLOSCHLIFF)

Stärke mm	1000 x 2000 mm kg/Tfl.	1250 x 2500 mm kg/Tfl.	1500 x 3000 mm kg/Tfl.
1,5	24,000	38,000	54,000
2,0	32,000	50,000	72,000

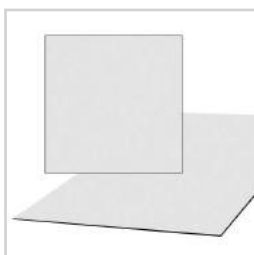

EDELSTAHLBLECH 1.4301 2B (IIIC)
BEIDSEITIG GESCHLIFFEN K240 + FOLIERT

Stärke mm	1000 x 2000 mm kg/Tfl.	1250 x 2500 mm kg/Tfl.	1500 x 3000 mm kg/Tfl.
1,5	24,000	38,000	54,000
2,0	32,000	50,000	72,000

Wir erweitern ständig unser Lagerprogramm, nicht aufgeführte Abmessungen sind auf Anfrage lieferbar.

EDELSTAHLBOGEN 1.4541 NORM 3S 90° EINNAHT
EN 10253-2

Abmessung
21,3 x 2 mm
25,0 x 2 mm
26,9 x 2 mm
30,0 x 2 mm
33,7 x 2 mm
40,0 x 2 mm
42,4 x 2 mm
48,3 x 2 mm
60,3 x 2 mm
76,1 x 2 mm



EDELSTAHLBOGEN 1.4307 NORM 3S 90° EINNAHT
EN 10253-2. GESCHL. K240

Abmessung
33,7 x 2 mm
42,4 x 2 mm



ABDECKTELLER LEICHT GEWÖLBT
EDELSTAHL 1.4301

Abmessung
27 x 1,5 mm
33 x 2,0 mm
42 x 2,0 mm
48 x 2,0 mm



RONDE GESCHLIFFEN, EINSEITIG FOLIERT
EDELSTAHL 1.4301

Außen Ø	Materialstärke
33 mm	4,0 mm
42 mm	4,0 mm
48 mm	4,0 mm
60 mm	4,0 mm
70 mm	4,0 mm
80 mm	4,0 mm
80 mm	6,0 mm
100 mm	6,0 mm
120 mm	6,0 mm

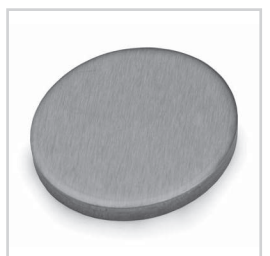

RONDE MIT 2 BOHRUNGEN GESCHL. EINSEITIG FOLIERT
EDELSTAHL 1.4301

Außen Ø	Bohrung	Materialstärke
100 mm	2 x 11 mm	6,0 mm



Wir erweitern ständig unser Lagerprogramm, nicht aufgeführte Abmessungen sind auf Anfrage lieferbar.



ROHR-ABSCHLUSSSTOPFEN GERADE
EDELSTAHL 1.4301

Außen Ø	Materialstärke
25,0 mm	2,0 mm
30,2 mm	2,0 mm
33,7 mm	2,0 mm
40,0 mm	2,0 mm



ROHR-ABSCHLUSSSTOPFEN GEWÖLBT
EDELSTAHL 1.4301 MIT GEWINDE M8

Außen Ø	Materialstärke
33,7 mm	2,0 mm
42,4 mm	2,0 mm
48,3 mm	2,0 mm



ROHR-ABSCHLUSSSTOPFEN GEWÖLBT
EDELSTAHL 1.4301

Außen Ø	Materialstärke
26,9 mm	2,0 mm
30,2 mm	2,0 mm
33,7 mm	2,0 mm
40,2 mm	2,0 mm
42,4 mm	2,0 mm
42,4 mm	2,6 mm
48,3 mm	2,0 mm
60,3 mm	2,0 mm



ROHR-KUGELSTOPFEN
EDELSTAHL 1.4301 EDELMATT

Außen Ø	Materialstärke
33,7 mm	2,0 mm
42,4 mm	2,0 mm
48,3 mm	2,0 mm



ROHR-ANSCHLUSSPLATTE
EDELSTAHL 1.4301 GEEIGNET FÜR RUNDROHR

Abmessung	Rohr Ø
64 x 24 x 4 mm	42,4 - 48,3 mm
64 x 24 x 4 mm	33,7 mm

Wir erweitern ständig unser Lagerprogramm, nicht aufgeführte Abmessungen sind auf Anfrage lieferbar.

HANDLAUFTRÄGERSTÜTZE GERADE
EDELSTAHL 1.4301 MIT GEWINDE M8

Länge	Ø
125 mm	12,0 mm



HANDLAUFTRÄGER MIT ROHRANSCHLUSSPLATTE
EDELSTAHL 1.4301 EDELMATT

Ø
12,0 mm



HANDLAUFTRÄGER ZUM ANSCHWEISSEN
EDELSTAHL 1.4301 MATTPOLIERT

Ø
12,0 mm



Gelenkstift mit Gewinde M8
EDELSTAHL 1.4301

Abmessung
14,0 x 52,0 mm



QUERSTABHALTER
FEINGUSS MATT POLIERT FÜR RUNDROHR MIT 424 MM

Bohrung	Ø	für Rohr
12,2 mm	22 mm	42,4 mm



ROHR-VERBINDUNGSSTÜCK
EDELSTAHL 1.4301

Abmessung
42,4 x 2 mm



Wir erweitern ständig unser Lagerprogramm, nicht aufgeführte Abmessungen sind auf Anfrage lieferbar.



ROHRECKE 90°
EDELSTAHL 1.4301

Abmessung

42,4 x 2,0 mm



WANDROSETTE
EDELSTAHL 1.4301 EDELMATT

Abmessung

Länge

45 x 10 mm

12,5 mm

76 x 13 mm

12,5 mm

76 x 13 mm

33,8 mm

76 x 13 mm

42,5 mm



MASSIVKUGEL MIT GEWINDEBUCHSE
EDELSTAHL 1.4301 (V2A) EDELMATT

Ø

Gewinde

15 mm

M 5

20 mm

M 5

25 mm

M 6

30 mm

M 6

40 mm

M 8

50 mm

M 8



HOHLKUGEL MIT GEWINDEBUCHSE
EDELSTAHL 1.4301 (V2A) EDELMATT

Ø

Gewinde

60 mm

M 8

70 mm

M 10

80 mm

M 10



ESG-KLEMMBEFESTIGUNG
EDELSTAHL (V2A) FÜR RUNDROHR 42.4 MM

Plattendicke

6,0 mm

8,0 mm

Wir erweitern ständig unser Lagerprogramm, nicht aufgeführte Abmessungen sind auf Anfrage lieferbar.

MUFFE EDELSTAHL 1.4301 + 1.4571
EN 10241

Zoll
3/8
1/2
3/4
1
1 1/4
1 1/2



ANSCHWEISSNIPPEL EDELSTAHL 1.4541
EN 10241

Zoll
1/2
3/4
3/8
1
1 1/4
1 1/2



WINKEL EDELSTAHL 1.4571
EN 10241

Zoll
1/2
3/4
1
1 1/4



T-STÜCK EDELSTAHL 1.4571
EN 10241

Zoll
1/2
3/4
1
1 1/4



Wir erweitern ständig unser Lagerprogramm, nicht aufgeführte Abmessungen sind auf Anfrage lieferbar.

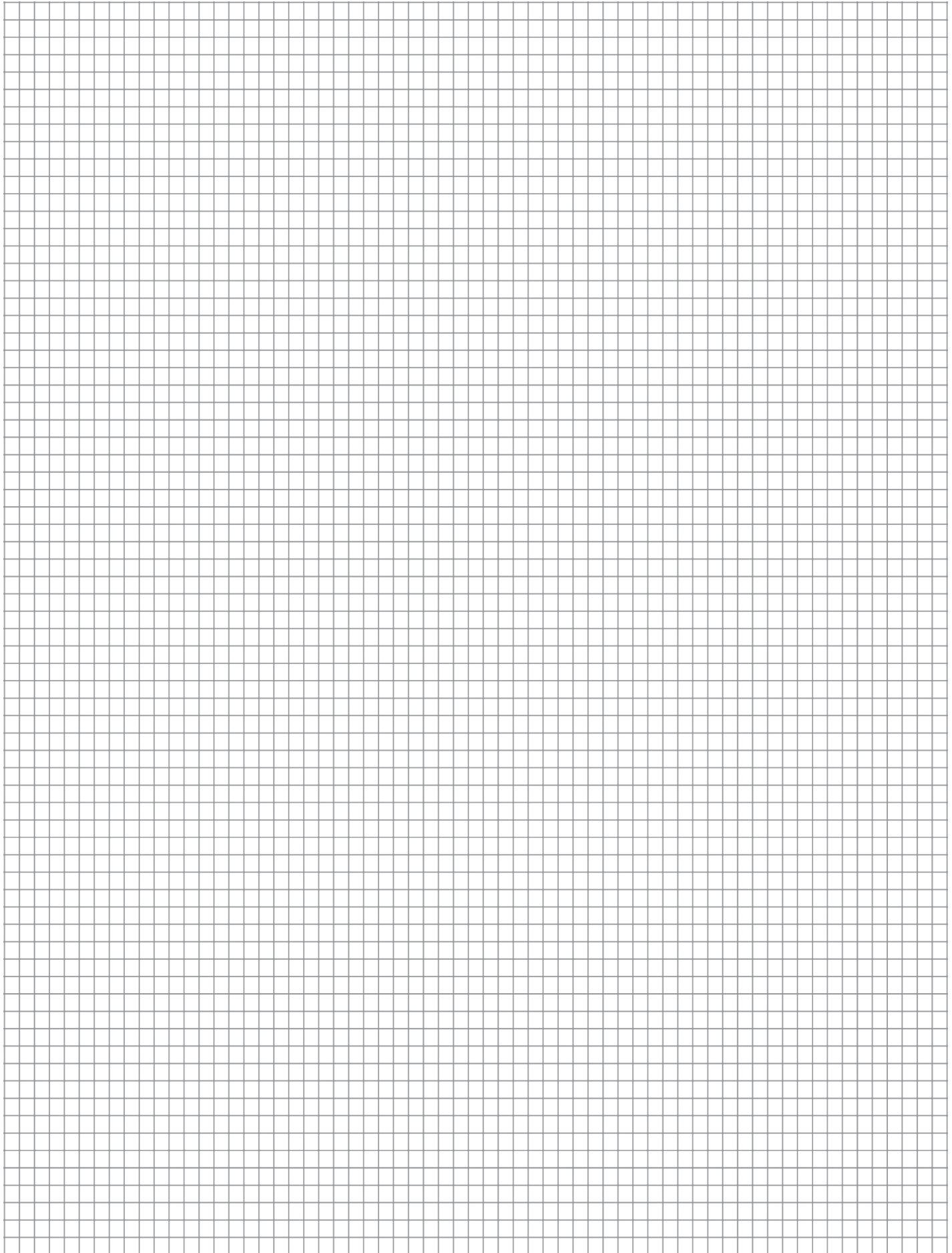

■ AlMgSi0.5 F22 AW6060 FLACH
EN755-5/EN573-3

mm	mm	6 mtr	kg/mtr
12	3	X	0,100
15	3	X	0,125
15	5	X	0,202
15	6	X	0,245
15	8	X	0,324
15	10	X	0,405
20	3	X	0,165
20	4	X	0,220
20	5	X	0,270
20	6	X	0,325
20	8	X	0,435
20	10	X	0,540
20	12	X	0,648
20	15	X	0,810
25	3	X	0,203
25	4	X	0,270
25	5	X	0,340
25	6	X	0,405
25	8	X	0,540
25	10	X	0,675
25	12	X	0,840
25	15	X	1,015
25	20	X	1,350
30	3	X	0,245
30	4	X	0,324
30	5	X	0,405
30	6	X	0,490
30	8	X	0,650
30	10	X	0,810
30	12	X	0,975
30	15	X	1,220
30	20	X	1,620
40	3	X	0,324
40	4	X	0,435
40	5	X	0,540
40	6	X	0,648
40	8	X	0,864
40	10	X	1,080
40	12	X	1,300
40	15	X	1,620
40	20	X	2,160
40	30	X	3,240
50	3	X	0,405
50	4	X	0,540

mm	mm	6 mtr	kg/mtr
50	5	X	0,675
50	6	X	0,810
50	8	X	1,080
50	10	X	1,350
50	12	X	1,620
50	15	X	2,030
50	20	X	2,700
60	3	X	0,486
60	4	X	0,650
60	5	X	0,810
60	6	X	0,972
60	8	X	1,300
60	10	X	1,620
60	12	X	1,940
60	15	X	2,430
60	20	X	3,240
70	5	X	0,945
70	10	X	1,890
80	3	X	0,650
80	4	X	0,860
80	5	X	1,080
80	6	X	1,300
80	8	X	1,730
80	10	X	2,160
80	12	X	2,592
80	15	X	3,240
80	20	X	4,320
90	10	X	2,430
100	3	X	0,810
100	4	X	1,100
100	5	X	1,350
100	6	X	1,620
100	8	X	2,160
100	10	X	2,700
100	15	X	4,050
100	20	X	5,600
120	5	X	1,620
120	6	X	1,944
120	8	X	2,600
120	10	X	3,240
120	15	X	4,860
120	20	X	6,480
150	10	X	4,050
200	10	X	5,400

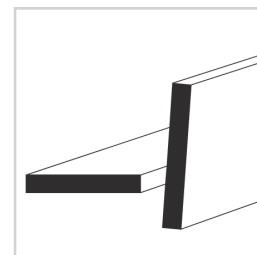

Wir erweitern ständig unser Lagerprogramm, nicht aufgeführte Abmessungen sind auf Anfrage lieferbar.

■ **AlMgSi0.5 AW6060 RUND**
EN755-3/EN573-3

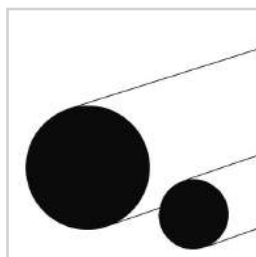

mm	6 mtr	kg/mtr
8	X	0,140
10	X	0,212
12	X	0,305
15	X	0,480
16	X	0,543
20	X	0,850

mm	6 mtr	kg/mtr
25	X	1,320
30	X	1,910
40	X	3,390
50	X	5,300
60	X	7,630

■ **AlMgSi0.5 F22 AW6060 VIERKANT**
EN755-4/EN573-3

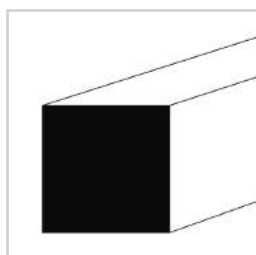

mm	6 mtr	kg/mtr
8	X	0,175
10	X	0,270
12	X	0,390
15	X	0,610
18	X	0,680

mm	6 mtr	kg/mtr
20	X	1,080
25	X	1,690
30	X	2,430
40	X	4,320
50	X	6,750

■ **AlMgSi0.5 F22 AW6060 U-PROFIL**
EN755-9/EN573-3

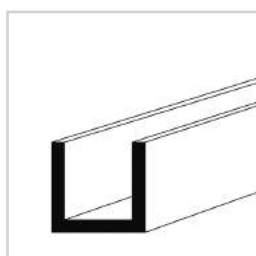

mm	mm	mm	6 mtr	kg/mtr
15	15	2	X	0,221
20	20	2	X	0,320
20	20	3	X	0,455
25	25	2	X	0,400
25	25	3	X	0,560
30	20	2	X	0,350
30	30	2	X	0,490
30	30	3	X	0,715
35	35	3	X	0,800

mm	mm	mm	6 mtr	kg/mtr
40	20	2	X	0,410
40	30	3	X	0,790
40	40	4	X	1,250
50	30	3	X	0,842
50	50	4	X	1,533
50	50	5	X	1,940
60	30	3	X	0,925
60	40	2,5	X	0,911
60	60	4	X	1,858

Wir erweitern ständig unser Lagerprogramm, nicht aufgeführte Abmessungen sind auf Anfrage lieferbar.

AIMgSI0.5 F22 AW6060 T-PROFIL
EN755-9/EN573-3

mm	mm	mm	6 mtr	kg/mtr	mm	mm	mm	6 mtr	kg/mtr
20	20	2	X	0,205	40	40	4	X	0,820
25	25	3	X	0,380	50	50	5	X	1,285
30	30	3	X	0,461	60	60	4	X	1,252

AIMgSI0.5 F22 AW6060 WINKEL GLEICHSCHENKLIG
EN755-9/EN573-3

mm	mm	mm	6 mtr	kg/mtr	mm	mm	mm	6 mtr	kg/mtr
15	15	2	X	0,151	45	45	2	X	0,480
15	15	3	X	0,220	50	50	2	X	0,531
20	20	2	X	0,205	50	50	3	X	0,785
20	20	3	X	0,299	50	50	4	X	1,040
25	25	2	X	0,259	50	50	5	X	1,290
25	25	3	X	0,380	60	60	2	X	0,637
25	25	4	X	0,500	60	60	3	X	0,950
30	30	2	X	0,313	60	60	4	X	1,252
30	30	3	X	0,465	60	60	5	X	1,552
30	30	4	X	0,604	60	60	6	X	1,850
30	30	5	X	0,742	60	60	8	X	2,420
35	35	2	X	0,370	80	80	4	X	1,685
35	35	3	X	0,545	80	80	6	X	2,500
40	40	2	X	0,423	80	80	8	X	3,283
40	40	3	X	0,650	100	100	4	X	2,110
40	40	4	X	0,824	100	100	6	X	3,140
40	40	5	X	1,015	100	100	10	X	5,200

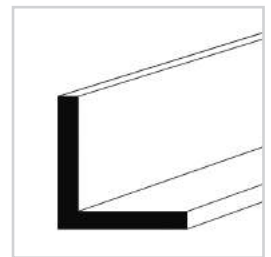

AIMgSI0.5 F22 AW6060 WINKEL GLEICHSCHENKLIG
EN755-9/EN573-3

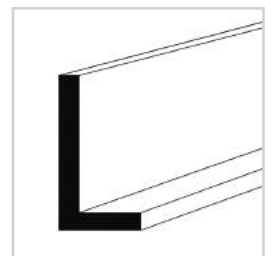
mm	mm	mm	6 mtr	kg/mtr	mm	mm	mm	6 mtr	kg/mtr
20	10	2	X	0,151	50	30	4	X	0,821
20	15	2	X	0,178	50	30	5	X	1,027
25	10	2	X	0,180	50	40	4	X	0,929
25	15	2	X	0,205	60	20	2	X	0,425
25	20	2	X	0,235	60	30	3	X	0,704
30	15	2	X	0,232	60	30	5	X	1,163
30	20	2	X	0,260	60	40	2	X	0,530
30	20	3	X	0,380	60	40	3	X	0,785
30	20	4	X	0,500	60	40	4	X	1,040
40	15	2	X	0,290	60	40	5	X	1,285
40	20	2	X	0,315	80	30	3	X	0,900
40	20	3	X	0,461	80	40	2	X	0,655
40	20	4	X	0,604	80	40	4	X	1,253
40	30	2	X	0,370	80	40	6	X	1,850
40	30	3	X	0,545	80	60	6	X	2,171
50	20	2	X	0,370	100	30	3	X	1,027
50	20	3	X	0,545	100	50	3	X	1,200
50	30	2	X	0,426	100	50	5	X	1,958
50	30	3	X	0,625					

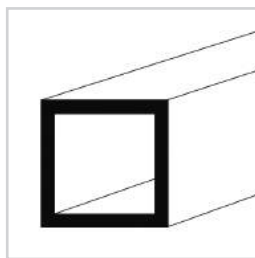

Wir erweitern ständig unser Lagerprogramm, nicht aufgeführte Abmessungen sind auf Anfrage lieferbar.

■ **AlMgSi0.5 F22 AW6060 QUADRATROHR**
EN755-8/EN573-3



mm	mm	mm	6 mtr	kg/mtr
15	15	2	X	0,281
20	20	2	X	0,388
20	20	3	X	0,550
25	25	2	X	0,497
25	25	3	X	0,713
30	30	2	X	0,615
30	30	3	X	0,880
35	35	2	X	0,756
40	40	2	X	0,826
40	40	3	X	1,199
40	40	4	X	1,560

mm	mm	mm	6 mtr	kg/mtr
50	50	2	X	1,037
50	50	3	X	1,540
50	50	4	X	1,987
60	60	2	X	1,253
60	60	3	X	1,820
60	60	4	X	2,419
80	80	3	X	2,495
80	80	4	X	3,283
100	100	3	X	3,143
100	100	4	X	4,150
100	100	5	X	5,130

■ **AlMgSi0.5 F22 AW6060 RECHTECKROHR**
EN755-8/EN573-3

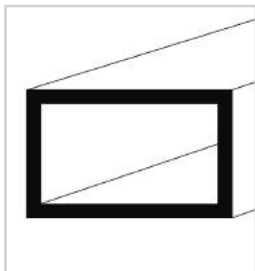

mm	mm	mm	6 mtr	kg/mtr
20	10	2	X	0,324
20	15	2	X	0,335
25	20	2	X	0,443
30	15	2	X	0,460
30	20	2	X	0,496
30	20	3	X	0,713
40	20	2	X	0,604
40	20	3	X	0,874
40	30	2	X	0,713
40	30	3	X	1,037
50	15	2	X	0,660
50	20	2	X	0,712
50	25	2	X	0,765
50	30	2	X	0,821
50	30	3	X	1,198
50	40	3	X	1,458
60	20	2	X	0,822
60	30	2	X	0,961
60	30	3	X	1,430
60	40	2	X	1,040
60	40	3	X	1,523

mm	mm	mm	6 mtr	kg/mtr
60	40	4	X	1,980
80	20	2	X	1,040
80	30	3	X	1,690
80	40	2	X	1,253
80	40	3	X	1,847
80	40	4	X	2,419
80	50	4	X	2,640
80	60	3	X	2,175
80	60	4	X	2,950
100	20	2	X	1,274
100	30	3	X	2,010
100	40	3	X	2,171
100	40	4	X	2,930
100	50	3	X	2,333
100	50	4	X	3,070
100	60	3	X	2,495
100	60	4	X	3,290
120	20	2	X	1,469
120	60	4	X	3,800
200	50	4	X	5,440

■ **AlMgSi0.5 F22 AW6060 RUNDROHR**
EN755-7/EN573-3

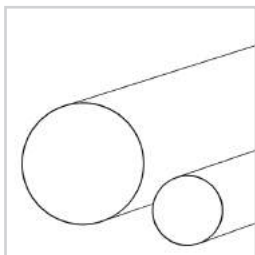

mm	mm	6 mtr	kg/mtr
16	2	X	0,240
20	2	X	0,305
20	3	X	0,433
20	5	X	0,670
25	2	X	0,390
25	3	X	0,560
30	2	X	0,475
30	3	X	0,660
32	2	X	0,509

mm	mm	6 mtr	kg/mtr
35	2	X	0,560
40	2	X	0,645
40	3	X	0,942
50	2	X	0,820
50	3	X	1,196
60	2	X	0,990
60	3	X	1,450
80	2	X	1,325
80	3	X	1,959

Wir erweitern ständig unser Lagerprogramm, nicht aufgeführte Abmessungen sind auf Anfrage lieferbar.

ALCU4PBMGMN AW2007T4 FLACH
EN755-5/EN573-3

mm	mm	3 mtr	kg/mtr
20	10	X	0,560
20	15	X	0,840
25	10	X	0,700
25	15	X	1,050
25	20	X	1,400
30	10	X	0,840
30	12	X	1,000
30	15	X	1,260
30	20	X	1,680
30	25	X	2,100
40	10	X	1,120
40	12	X	1,340
40	15	X	1,680
40	20	X	2,240
40	25	X	2,800
40	30	X	3,360
50	10	X	1,400
50	15	X	2,100
50	20	X	2,800
50	25	X	3,375
50	30	X	4,200
50	40	X	5,600

mm	mm	3 mtr	kg/mtr
60	10	X	1,680
60	12	X	1,950
60	15	X	2,520
60	20	X	3,360
60	30	X	4,860
60	40	X	6,720
80	10	X	2,240
80	12	X	2,690
80	15	X	3,360
80	20	X	4,480
80	30	X	6,720
80	40	X	8,960
100	10	X	2,800
100	12	X	3,360
100	15	X	4,200
100	20	X	5,600
100	30	X	8,400
100	40	X	11,200
100	50	X	14,000
120	20	X	6,700
120	30	X	10,000

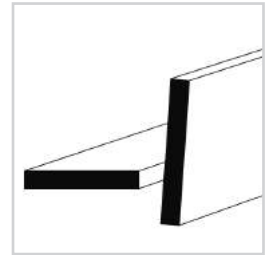
ALCU4PBMGMN AW2007T4 RUND
EN755-3/EN754-3/EN573-3

mm	3 mtr	kg/mtr
6	X	0,080
8	X	0,140
10	X	0,220
12	X	0,320
15	X	0,490
16	X	0,563
20	X	0,880
25	X	1,370
28	X	1,760
30	X	1,980
32	X	2,250
35	X	2,690
40	X	3,520
45	X	4,450
50	X	5,490
55	X	6,650
60	X	7,910

mm	3 mtr	kg/mtr
65	X	9,300
70	X	10,770
75	X	12,370
80	X	14,070
85	X	15,700
90	X	17,500
95	X	21,000
100	X	21,980
110	X	26,600
120	X	31,200
130	X	37,200
140	X	43,000
150	X	48,600
160	X	56,000
180	X	72,500
200	X	87,300

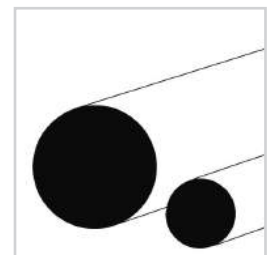
ALCU4PBMGMN AW2007T4 VIERKANT
EN754-4/EN573-3

mm	3 mtr	kg/mtr
15	X	0,630
20	X	1,120
25	X	1,750
30	X	2,520
40	X	4,480

mm	3 mtr	kg/mtr
50	X	7,000
60	X	10,100
70	X	13,700
80	X	17,900
100	X	28,000

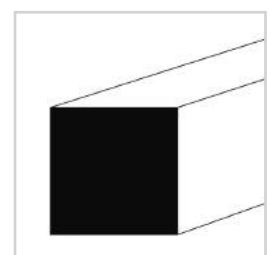

Wir erweitern ständig unser Lagerprogramm, nicht aufgeführte Abmessungen sind auf Anfrage lieferbar.

■ **BLECH AL99.5 AW1050A H14/H24**
EN573-3/EN485-1

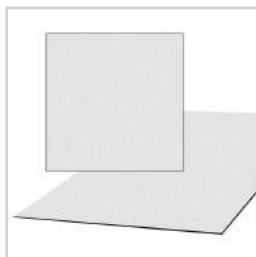

Stärke mm	1000 x 2000 mm kg/Tfl.	1250 x 2500 mm kg/Tfl.	1500 x 3000 mm kg/Tfl.
0,8	4,400	6,800	
1,0	5,500	8,500	12,200
1,5	8,500	13,000	18,500
2,0	11,000	17,000	25,000
2,5	13,500	21,500	30,500
3,0	16,500	25,500	37,000
4,0	22,000	34,000	50,000
5,0	27,000	43,000	61,000

■ **BLECH AL99.5 AW1050A H14/H24 EINSEITIG FOLIERT**
EN573-3/EN485-1

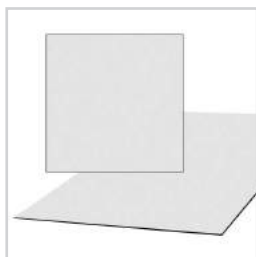

Stärke mm	1000 x 2000 mm kg/Tfl.	1250 x 2500 mm kg/Tfl.	1500 x 3000 mm kg/Tfl.
1,5	8,500	13,000	18,500
2,0	11,000	17,000	25,000
3,0	16,500	25,500	37,000

■ **BLECH ALMG1 AW5005 H14/H24 EINSEITIG FOLIERT**
BANDELOX. E6/EV1

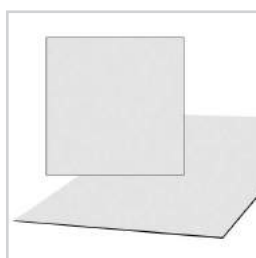

Stärke mm	1000 x 2000 mm kg/Tfl.	1250 x 2500 mm kg/Tfl.	1500 x 3000 mm kg/Tfl.
2	11,000	17,000	25,000

Wir erweitern ständig unser Lagerprogramm, nicht aufgeführte Abmessungen sind auf Anfrage lieferbar.

BLECH AlMg3 AW5754 H22
EN573-3/EN485-1

Stärke mm	1000 x 2000 mm kg/Tfl.	1250 x 2500 mm kg/Tfl.	1500 x 3000 mm kg/Tfl.
1,0	5,500	8,500	12,200
1,5	8,500	13,000	18,500
2,0	11,000	17,000	25,000
2,5	13,500	21,500	30,500
3,0	16,500	25,500	37,000
4,0	22,000	34,000	50,000
5,0	27,000	43,000	61,000

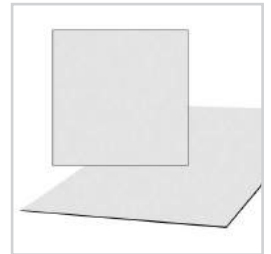
BLECH AlMg3 AW5754 H111
EN485-3/EN573-3

Stärke mm	1000 x 2000 mm kg/Tfl.	1250 x 2500 mm kg/Tfl.	1500 x 3000 mm kg/Tfl.
6,0	33,000	51,000	73,000
8,0	44,000	68,000	98,000
10,0	56,000	87,000	126,000

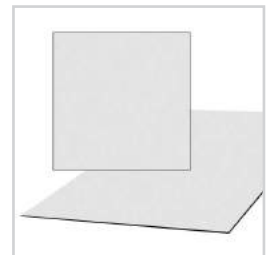

BLECH AlMg3 AW5754 H22 EINSEITIG FOLIERT
EN573-3/EN485-1

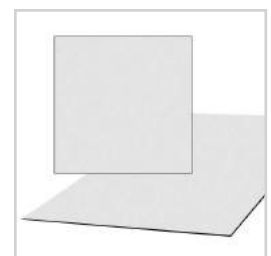
Stärke mm	1000 x 2000 mm kg/Tfl.	1250 x 2500 mm kg/Tfl.	1500 x 3000 mm kg/Tfl.
1,5	8,500	13,000	18,500
2,0	11,000	17,000	25,000
3,0	16,500	25,500	37,000

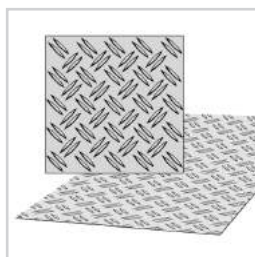

Wir erweitern ständig unser Lagerprogramm, nicht aufgeführte Abmessungen sind auf Anfrage lieferbar.

■ **DUETT-WARZENBLECH AIMg3 AW5754**
EN1386/EN573-3



Stärke mm	1000 x 2000 mm kg/Tfl.	1250 x 2500 mm kg/Tfl.	1500 x 3000 mm kg/Tfl.
1,5/2,0	9,000	14,000	20,000
2,5/4,0	15,500	24,000	34,500
3,5/5,0	21,000	32,500	47,000
5,0/6,5	29,000	45,000	65,000
8,0/9,5	46,000	71,000	102,000

■ **QUINTETT-WARZENBLECH AIMg3 AW5754**
EN1386/EN573-3

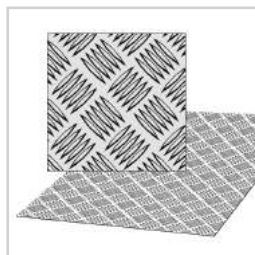

Stärke mm	1000 x 2000 mm kg/Tfl.	1250 x 2500 mm kg/Tfl.	1500 x 3000 mm kg/Tfl.
2,5/4,0	16,000	24,500	35,000
3,5/5,0	21,500	33,000	47,500
5,0/6,5	29,500	45,500	66,000

Wir erweitern ständig unser Lagerprogramm, nicht aufgeführte Abmessungen sind auf Anfrage lieferbar.

KUPFER CU-ETP CW004A/005A RUND
EN12164/EN1982

mm	4 mtr	kg/mtr	mm	4 mtr	kg/mtr
6,0	X	0,250	20,0	X	2,800
8,0	X	0,450	25,0	X	4,370
10,0	X	0,700	30,0	X	6,290
12,0	X	1,010	40,0	X	11,800
15,0	X	1,570	50,0	X	17,480

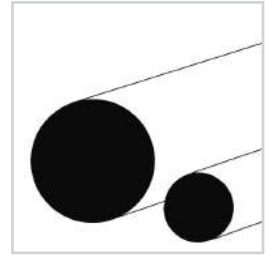
KUPFER CU-ETP CW004A/005A VIERKANT
EN12164/EN1982

mm	4 mtr	kg/mtr	mm	4 mtr	kg/mtr
8,0	X	0,570	25,0	X	5,560
10,0	X	0,890	30,0	X	8,010
15,0	X	2,000	50,0	X	22,250
20,0	X	3,560			

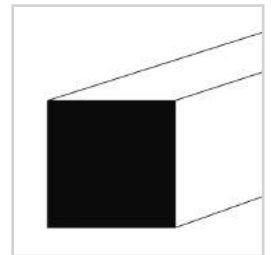
KUPFERBLECH CU-DHP CW024A HALBHART
EN1652/EN1982

Stärke mm	1000 x 2000 mm kg/Tfl,
0,6	10,800
0,7	12,500
0,8	14,300
1,0	18,000
1,5	27,000
2,0	36,000
3,0	54,000

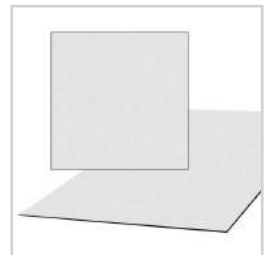
ROTGUSS CuSn7ZnPb7 CC493K RUND
EN12164/EN1982

mm	3 mtr	kg/mtr	mm	3 mtr	kg/mtr
21,0	X	3,000	41,0	X	11,900
26,0	X	4,800	51,0	X	18,400
31,0	X	6,800	61,0	X	26,300

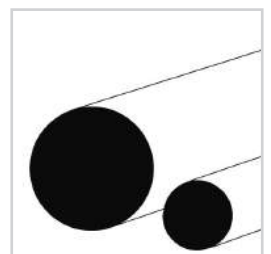

Wir erweitern ständig unser Lagerprogramm, nicht aufgeführte Abmessungen sind auf Anfrage lieferbar.

MESSING CuZn39Pb3 CW614N RUND

EN12164/EN1982

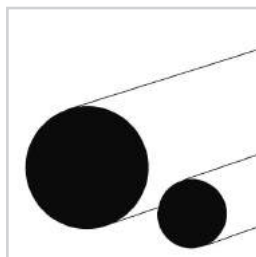

mm	3 mtr	kg/mtr	mm	3 mtr	kg/mtr
3	X	0,060	25	X	4,170
4	X	0,100	30	X	6,010
5	X	0,160	35	X	8,180
6	X	0,240	40	X	10,700
8	X	0,420	42	X	11,800
10	X	0,670	45	X	13,500
12	X	0,960	50	X	16,700
14	X	1,310	60	X	24,030
15	X	1,500	70	X	32,700
16	X	1,710	80	X	42,700
18	X	2,160	90	X	54,000
20	X	2,670	100	X	66,700
22	X	3,230	120	X	96,100

MESSING CuZn39Pb3 CW614N VIERKANT

EN12164/EN1982

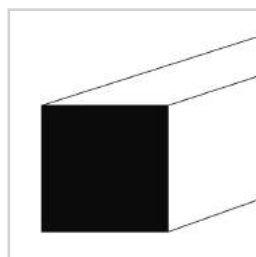

mm	3 mtr	kg/mtr	mm	3 mtr	kg/mtr
10	X	0,850	30	X	7,650
15	X	1,910	40	X	13,600
20	X	3,400	50	X	21,250
25	X	5,310			

MESSINGBLECH CuZn37 CW508L

EN1652/EN1982

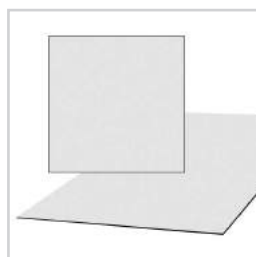

Stärke mm	1000 x 2000 mm kg/Tfl.
1,0	17,000
1,5	26,000
2,0	34,000
3,0	52,000
4,0	68,000

MASSIVKUGEL MESSING POLIERT MIT GEWINDEBUCHSE



Ø	Gewinde
20 mm	M 5
25 mm	M 6
30 mm	M 6
40 mm	M 8
50 mm	M 8

HOHLKUGEL MESSING POLIERT MIT GEWINDEBUCHSE



Ø	Gewinde
60 mm	M 8

Wir erweitern ständig unser Lagerprogramm, nicht aufgeführte Abmessungen sind auf Anfrage lieferbar.



BEWEHRUNGSTECHNIK HALFEN



BETON, FASSADE, MONTAGETECHNIK – in diesen drei Bereichen bieten wir Ihnen eine breite Produktpalette. Dabei steht hinter jedem Produkt die Qualität und die technische Kompetenz einer bekannten Marke. HALFEN, DEHA und FRIMEDA, das sind die Marken, mit denen HALFEN für jede Befestigungsaufgabe das geeignete System bietet. Wir bieten anwendungsorientierte Lösungen mit hohem technischen Anspruch und auf höchstem Qualitäts- und Sicherheitsniveau.

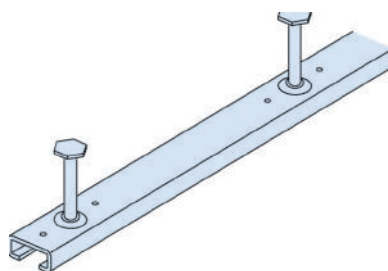

**HALFEN ANKERSCHIENE FEUERVERZINKT
KALTPROFILIERT**

Typ	Bezeichnung	Länge
HTA	28/15	10 cm
HTA	28/15	15 cm
HTA	28/15	20 cm
HTA	28/15	25 cm
HTA	28/15	30 cm
HTA	28/15	35 cm
HTA	28/15	40 cm
HTA	28/15	55 cm
HTA	28/15	80 cm
HTA	28/15	105 cm
HTA	28/15	205 cm
HTA	28/15	607 cm
HTA	38/17	10 cm
HTA	38/17	15 cm
HTA	38/17	20 cm
HTA	38/17	25 cm
HTA	38/17	30 cm
HTA	38/17	35 cm
HTA	38/17	40 cm
HTA	38/17	55 cm
HTA	38/17	80 cm
HTA	38/17	105 cm
HTA	38/17	205 cm
HTA	38/17	607 cm
HTA	40/25	607 cm
HTA	49/30	607 cm

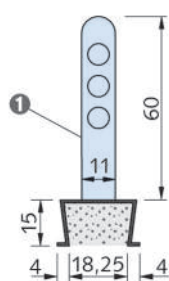
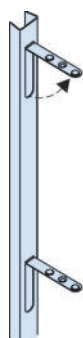

**HALFEN MAUERANSCHLUSSSCHIENE
SENDZIMIERVERZINKT**

Typ	Bezeichnung	Länge
HMS	25/15-D	250 cm

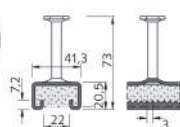
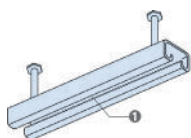

**HALFEN ANKERSCHIENE GEZAHNT FEUERVERZINKT
KALTPROFILIERT**

Typ	Bezeichnung	Länge
HZA	41/22	10 cm
HZA	41/22	15 cm
HZA	41/22	20 cm
HZA	41/22	25 cm
HZA	41/22	30 cm
HZA	41/22	35 cm
HZA	41/22	40 cm
HZA	41/22	607 cm

Wir erweitern ständig unser Lagerprogramm, nicht aufgeführte Abmessungen sind auf Anfrage lieferbar.



HALFEN Ankerschienen



HALFEN HMS Maueranschlussschiene



HALFEN HBS-05 Bewehrungsschraubanschlüsse



HALFEN HZA Ankerschiene gezahnt



HALFEN Trapezblech Befestigungsschiene



HALFEN HBT Bewehrungsrückbiegeanschluss



HALFEN Sparrenfuß



HALFEN Grip-Connector



Torx - Einsatz

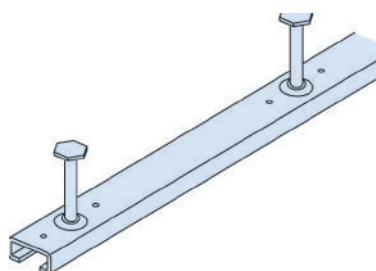

HALFEN ANKERSCHIENE EDELSTAHL A4
KALTPROFILIERT 1.4571 / 1.4401

Typ	Bezeichnung	Länge
HTA	28/15	10 cm
HTA	28/15	15 cm
HTA	28/15	20 cm
HTA	28/15	25 cm
HTA	28/15	30 cm
HTA	28/15	105 cm
HTA	28/15	607 cm
HTA	38/17	10 cm
HTA	38/17	15 cm
HTA	38/17	20 cm
HTA	38/17	25 cm
HTA	38/17	30 cm
HTA	38/17	35 cm
HTA	38/17	607 cm

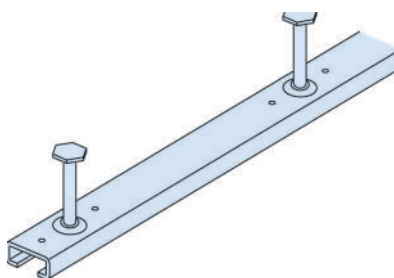

HALFEN ANKERSCHIENE „TYP K“ EDELSTAHL A4
KALTPROFILIERT 1.4571 / 1.4401

Mit verkürztem Ankerabstand

Typ	Bezeichnung	Länge
HTA	38/17	607 cm

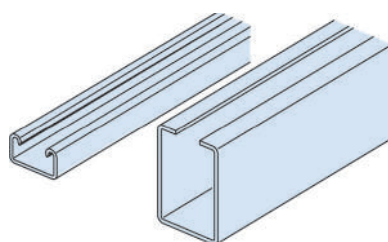

HALFEN MONTAGESCHIENE WALZBLANK
KALTPROFILIERT

Typ	Bezeichnung	Länge
HM	20/12	600 cm
HM	28/12	600 cm
HM	28/15	607 cm
HM	28/28	600 cm
HM	315	600 cm
HM	36/20	600 cm
HM	36/36	600 cm
HM	38/17	607 cm
HM	40/25	607 cm
HM	41/22	600 cm
HM	41/22-D	600 cm
HM	41/41	600 cm
HM	41/62	600 cm
HM	422	600 cm
HM	486	600 cm
HM	49/30	607 cm
HM	50/40	600 cm

Wir erweitern ständig unser Lagerprogramm, nicht aufgeführte Abmessungen sind auf Anfrage lieferbar.

**HALFEN MONTAGESCHIENE GEZAHNT WALZBLANK
KALTPROFILIERT**

Typ	Bezeichnung	Länge
HZM	41/22	607 cm

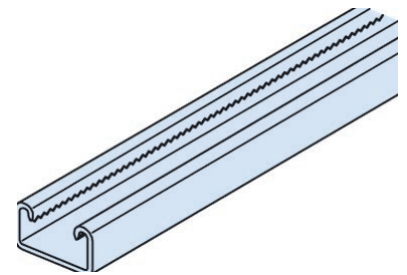
**HALFEN MONTAGESCHIENE FEUERVERZINKT
KALTPROFILIERT**

Typ	Bezeichnung	Länge
HM	20/12	600 cm
HM	28/12	600 cm
HM	28/15	607 cm
HM	28/28	600 cm
HM	315	600 cm
HM	36/20	600 cm
HM	36/36	600 cm
HM	38/17	607 cm
HM	40/25	607 cm
HM	41/22	600 cm
HM	41/41	600 cm
HM	422	600 cm
HM	49/30	607 cm
HM	50/40	600 cm

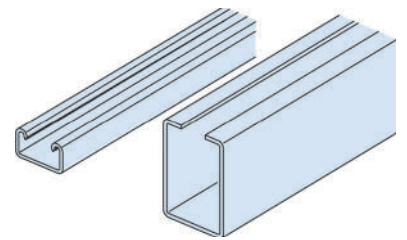
**HALFEN MONTAGESCHIENE GEZAHNT FEUERVERZINKT
KALTPROFILIERT**

Typ	Bezeichnung	Länge
HZM	41/22	607 cm

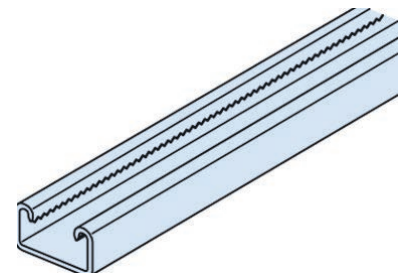

**HALFEN MONTAGESCHIENE SENDZIMIRVERZINKT
KALTPROFILIERT**

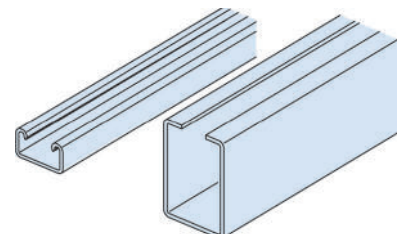
Typ	Bezeichnung	Länge
HM	35/50	600 cm
HM	41/22	600 cm

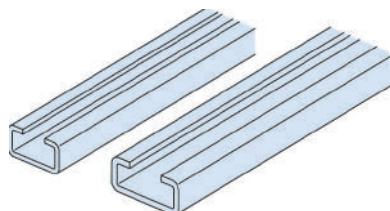

Wir erweitern ständig unser Lagerprogramm, nicht aufgeführte Abmessungen sind auf Anfrage lieferbar.

HALFEN MONTAGESCHIENE EDELSTAHL A2
KALTPROFILIERT 1.4301



Typ	Bezeichnung	Länge
HM	20/12	600 cm
HM	28/15	607 cm
HM	38/17	607 cm
HM	40/25	607 cm
HM	49/30	607 cm

HALFEN MONTAGESCHIENE EDELSTAHL A4
KALTPROFILIERT 1.4571 / 1.4401

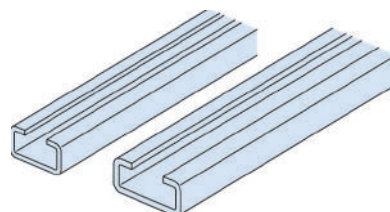

Typ	Bezeichnung	Länge
HM	28/15	607 cm
HM	38/17	607 cm

HALFEN MONTAGESCHIENE WALZBLANK
KALTPROFILIERT

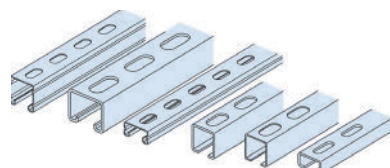

Typ	Bezeichnung	Länge
HL	20/12	600 cm
HL	28/15	607 cm
HL	28/28	600 cm
HL	36/36	600 cm
HL	41/22	600 cm
HL	41/41	600 cm
HL	50/40	600 cm

HALFEN LOCHSCHIENE SK WALZBLANK
KALTPROFILIERT

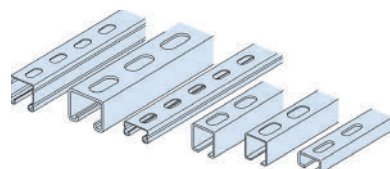

Lochung 6.5 x 30 mm

Typ	Bezeichnung	Länge
HL	28/15	607 cm

HALFEN LOCHSCHIENE FEUERVERZINKT
KALTPROFILIERT

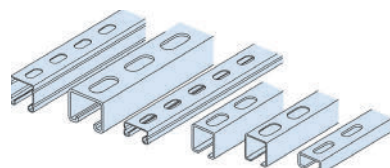

Typ	Bezeichnung	Länge
HL	20/12	600 cm
HL	28/15	607 cm
HL	28/28	600 cm
HL	36/36	600 cm
HL	41/22	600 cm
HL	41/41	600 cm
HL	50/40	600 cm

Wir erweitern ständig unser Lagerprogramm, nicht aufgeführte Abmessungen sind auf Anfrage lieferbar.

HALFEN LOCHSCHIENE SENDZIMIRVERZINKT
KALTPROFILIERT

Typ	Bezeichnung	Länge
HL	28/28	600 cm
HL	41/22	600 cm

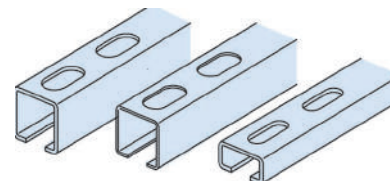
HALFEN LOCHSCHIENE EDELSTAHL A2
KALTPROFILIERT 1.4301

Typ	Bezeichnung	Länge
HL	20/12	600 cm
HL	28/15	607 cm

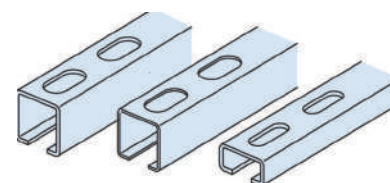
HALFEN ANKERSCHIENE GEZAHNT DYNAGRIP
WARMGEWALZT, FEUERVERZINKT

Typ	Bezeichnung	Länge
HZA	29/20	607 cm
HZA	38/23	607 cm

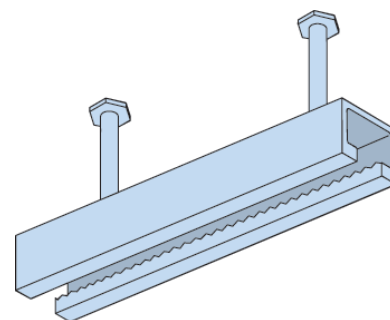
HALFEN MONTAGESCHIENE GEZAHNT DYNAGRIP
WARMGEWALZT, FEUERVERZINKT

Typ	Bezeichnung	Länge
HZM	29/20	607 cm
HZM	38/23	607 cm

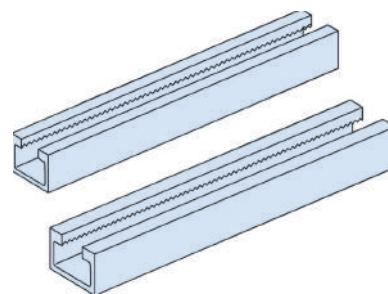

Wir erweitern ständig unser Lagerprogramm, nicht aufgeführte Abmessungen sind auf Anfrage lieferbar.

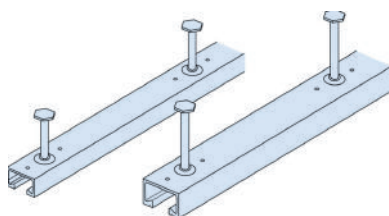

**HALFEN ANKERSCHIENE FEUERVERZINKT
WARMGEWALZT**

Typ	Bezeichnung	Länge
HTA	40/22	15 cm
HTA	40/22	20 cm
HTA	40/22	25 cm
HTA	40/22	30 cm
HTA	40/22	35 cm
HTA	40/22	40 cm
HTA	40/22	55 cm
HTA	40/22	80 cm
HTA	40/22	105 cm
HTA	40/22	607 cm
HTA	50/30	15 cm
HTA	50/30	20 cm
HTA	50/30	25 cm
HTA	50/30	30 cm
HTA	50/30	35 cm
HTA	50/30	40 cm
HTA	50/30	55 cm
HTA	50/30	80 cm
HTA	50/30	105 cm
HTA	50/30	607 cm

Ausführung Ankerschienen CE ETA auf Anfrage

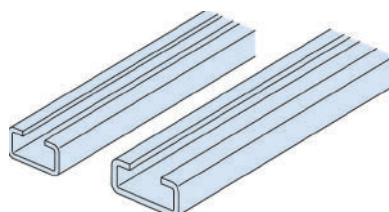

**HALFEN MONTAGESCHIENE WALZBLANK
WARMGEWALZT**

Typ	Bezeichnung	Länge
HM	40/22	607 cm
HM	50/30	607 cm

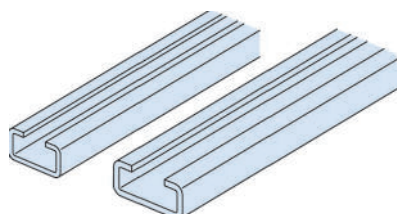

**HALFEN MONTAGESCHIENE FEUERVERZINKT
WARMGEWALZT**

Typ	Bezeichnung	Länge
HM	40/22	607 cm
HM	50/30	607 cm

Wir erweitern ständig unser Lagerprogramm, nicht aufgeführte Abmessungen sind auf Anfrage lieferbar.

HALFEN ANKERSCHIENE FEUERVERZINKT
WARMGEWALZT

schwer

Typ	Bezeichnung	Länge
HTA	52/34	15 cm
HTA	52/34	20 cm
HTA	52/34	25 cm
HTA	52/34	30 cm
HTA	52/34	40 cm
HTA	52/34	80 cm
HTA	52/34	607 cm
HTA	72/48	30 cm
HTA	72/48	607 cm

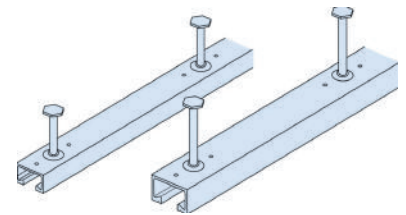
HALFEN MONTAGESCHIENE WALZBLANK
WARMGEWALZT

schwer

Typ	Bezeichnung	Länge
HM	52/34	607 cm
HM	72/48	607 cm

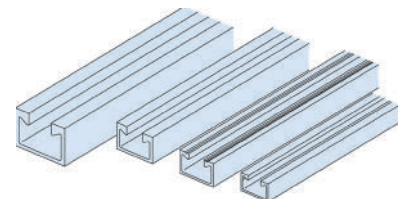

HALFEN MONTAGESCHIENE FEUERVERZINKT
WARMGEWALZT

schwer

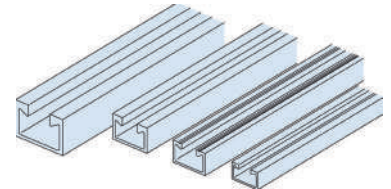
Typ	Bezeichnung	Länge
HM	52/34	607 cm
HM	72/48	607 cm

HALFEN MONTAGESCHIENE EDELSTAHL A4
WARMGEWALZT 1.4571 / 1.4401

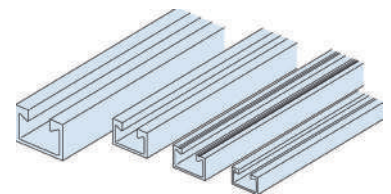
Typ	Bezeichnung	Länge
HM	40/22	607 cm

HALFEN TRAPEZBLECH-BEFESTIGUNGSSCHIENE
FEUERVERZINKT

Typ	Bezeichnung	Länge
HTU 60/22/3	AN2	300 cm
HTU 60/22/3	D2	300 cm
HTU 60/22/3	AN3	300 cm
HTU 60/22/6	AN2	300 cm

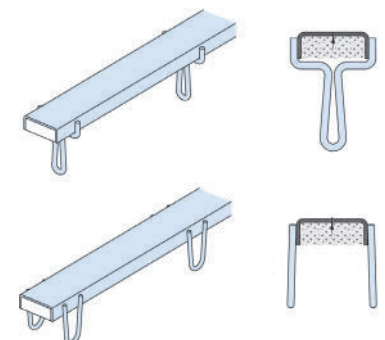

Wir erweitern ständig unser Lagerprogramm, nicht aufgeführte Abmessungen sind auf Anfrage lieferbar.

■ HALFEN MUFFENSTAB MIT SCHRAUBMUFFE



Typ	Bezeichnung
HS-05-S	12/400
HBS-05-S	12/610
HBS-05-S	12/860
HBS-05-S	12/1180
HBS-05-S	14/990
HBS-05-S	14/1370
HBS-05-S	16/400
HBS-05-S	16/1110
HBS-05-S	16/1570
HBS-05-S	20/400
HBS-05-S	20/1380
HBS-05-S	25/400
HBS-05-S	25/1730
HBS-05-S	28/400
HBS-05-S	28/1930

■ HALFEN ANSCHLUSSSTAB



Typ	Bezeichnung
HBS-05-A	12/400
HBS-05-A	12/590
HBS-05-A	12/840
HBS-05-A	12/1160
HBS-05-A	14/970
HBS-05-A	14/1350
HBS-05-A	16/375
HBS-05-A	16/1085
HBS-05-A	16/1545
HBS-05-A	20/370
HBS-05-A	20/1350
HBS-05-A	25/360
HBS-05-A	25/1690
HBS-05-A	28/360
HBS-05-A	28/1890

Wir erweitern ständig unser Lagerprogramm, nicht aufgeführte Abmessungen sind auf Anfrage lieferbar.

**HALFEN NAGELTELLER KUNSTSTOFF
FÜR MUFFENSTAB**

Typ	Ø
HBS-05	12 mm
HBS-05	14 mm
HBS-05	16 mm
HBS-05	20 mm

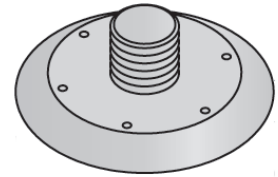
**HALFEN METALL-NAGELPLATTE
OHNE SCHRAUBE**

Typ	Ø
HBS-05	25 mm

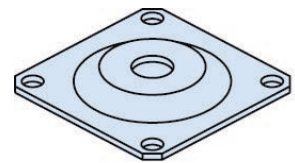

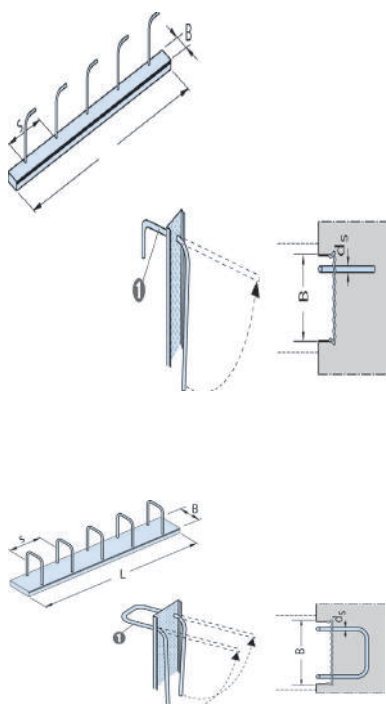

**HALFEN BEWEHRUNGS-RÜCKBIEGEANSCHLUSS
TYP 5 BÜGELELEMENT**

Typ	Bezeichnung	Breite	Länge	für Wand
HBT 55	8/15	58 mm	1250 mm	-
HBT 55	10/15	58 mm	1250 mm	-
HBT 85	12/15	86 mm	1250 mm	-
HBT 120	8/15	122 mm	1250 mm	13-18 cm
HBT 120	10/15	122 mm	1250 mm	13-18 cm
HBT 120	12/15	122 mm	1250 mm	13-18 cm
HBT 150	8/15	150 mm	1250 mm	16-21 cm
HBT 150	10/15	150 mm	1250 mm	16-21 cm
HBT 150	12/15	150 mm	1250 mm	16-21 cm
HBT 190	8/15	186 mm	1250 mm	19-24 cm
HBT 190	10/15	186 mm	1250 mm	19-24 cm
HBT 190	12/15	186 mm	1250 mm	19-24 cm
HBT 220	8/15	222 mm	1250 mm	23-28 cm
HBT 220	10/15	222 mm	1250 mm	23-28 cm
HBT 220	12/15	222 mm	1250 mm	23-28 cm

HALFEN GRIP-CONNECTOR

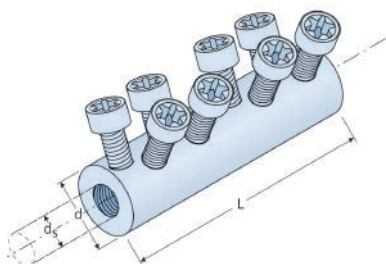

Typ	Abmessung
HGC 12	31.8 x 100 mm
HGC 14	38.0 x 112 mm
HGC 16	38.0 x 140 mm
HGC 20	48.3 x 164 mm
HGC 25	51.0 x 216 mm
HGC 28	60.3 x 252 mm



**TORX-EINSATZ
FÜR 25 UND 28 MM**

Typ	Bezeichnung
HGC	22 x T80

Wir erweitern ständig unser Lagerprogramm, nicht aufgeführte Abmessungen sind auf Anfrage lieferbar.

HALFEN SCHRAUBE GALVANISCH VERZINKT 4.6

Typ	Bezeichnung	Gewinde	VPE
HS	20/12	M 6 x 20	100 Stk.
HS	20/12	M 8 x 15	100 Stk.
HS	20/12	M 8 x 20	100 Stk.
HS	20/12	M 8 x 25	100 Stk.
HS	20/12	M 8 x 30	100 Stk.
HS	20/12	M 8 x 40	100 Stk.

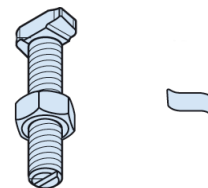

HALFEN SCHRAUBE GALVANISCH VERZINKT

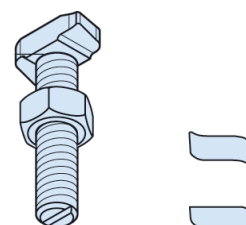
Typ	Bezeichnung	Gewinde	VPE
HS	28/15	M 6 x 15	100 Stk.
HS	28/15	M 6 x 20	100 Stk.
HS	28/15	M 6 x 40	100 Stk.
HS	28/15	M 8 x 15	100 Stk.
HS	28/15	M 8 x 20	100 Stk.
HS	28/15	M 8 x 25	100 Stk.
HS	28/15	M 8 x 30	100 Stk.
HS	28/15	M 8 x 40	100 Stk.
HS	28/15	M 8 x 50	100 Stk.
HS	28/15	M 8 x 60	100 Stk.
HS	28/15	M 8 x 80	100 Stk.
HS	28/15	M 10 x 20	100 Stk.
HS	28/15	M 10 x 25	100 Stk.
HS	28/15	M 10 x 30	100 Stk.
HS	28/15	M 10 x 40	100 Stk.
HS	28/15	M 10 x 50	100 Stk.
HS	28/15	M 10 x 60	100 Stk.
HS	28/15	M 10 x 80	100 Stk.
HS	28/15	M 10 x 125	50 Stk.
HS	28/15	M 10 x 150	50 Stk.
HS	28/15	M 12 x 30	100 Stk.
HS	28/15	M 12 x 50	50 Stk.

HALFEN SCHRAUBE EDELSTAHL (A2-70)

1.4301

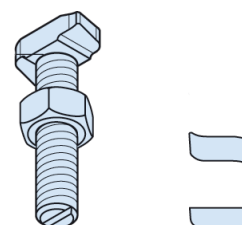
Typ	Bezeichnung	Gewinde	VPE
HS	28/15	M 8 x 30	100 Stk.
HS	28/15	M 10 x 20	100 Stk.
HS	28/15	M 10 x 30	100 Stk.



Wir erweitern ständig unser Lagerprogramm, nicht aufgeführte Abmessungen sind auf Anfrage lieferbar.

■ **HALFEN SCHRAUBE GALVANISCH VERZINKT 4.6**

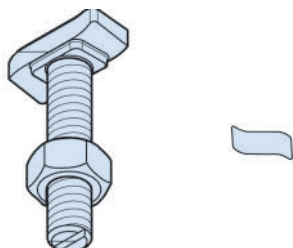

Typ	Bezeichnung	Gewinde	VPE
HS	38/17	M 10 x 20	100 Stk.
HS	38/17	M 10 x 30	100 Stk.
HS	38/17	M 10 x 40	100 Stk.
HS	38/17	M 10 x 50	100 Stk.
HS	38/17	M 10 x 60	100 Stk.
HS	38/17	M 10 x 80	50 Stk.
HS	38/17	M 10 x 100	50 Stk.
HS	38/17	M 10 x 150	50 Stk.
HS	38/17	M 12 x 20	100 Stk.
HS	38/17	M 12 x 30	100 Stk.
HS	38/17	M 12 x 40	50 Stk.
HS	38/17	M 12 x 50	50 Stk.
HS	38/17	M 12 x 60	50 Stk.
HS	38/17	M 12 x 80	50 Stk.
HS	38/17	M 12 x 100	50 Stk.
HS	38/17	M 12 x 125	50 Stk.
HS	38/17	M 12 x 150	25 Stk.
HS	38/17	M 12 x 200	25 Stk.
HS	38/17	M 16 x 30	50 Stk.
HS	38/17	M 16 x 40	50 Stk.
HS	38/17	M 16 x 50	50 Stk.
HS	38/17	M 16 x 60	50 Stk.
HS	38/17	M 16 x 80	25 Stk.
HS	38/17	M 16 x 100	25 Stk.
HS	38/17	M 16 x 125	25 Stk.
HS	38/17	M 16 x 150	25 Stk.
HS	38/17	M 16 x 200	25 Stk.

Wir erweitern ständig unser Lagerprogramm, nicht aufgeführte Abmessungen sind auf Anfrage lieferbar.

HALFEN SCHRAUBE GALVANISCH VERZINKT 4.6

Typ	Bezeichnung	Gewinde	VPE
HS	40/22	M 10 x 20	100 Stk.
HS	40/22	M 10 x 30	100 Stk.
HS	40/22	M 10 x 40	100 Stk.
HS	40/22	M 10 x 50	100 Stk.
HS	40/22	M 10 x 60	100 Stk.
HS	40/22	M 10 x 80	50 Stk.
HS	40/22	M 10 x 100	50 Stk.
HS	40/22	M 12 x 20	100 Stk.
HS	40/22	M 12 x 30	100 Stk.
HS	40/22	M 12 x 40	50 Stk.
HS	40/22	M 12 x 50	50 Stk.
HS	40/22	M 12 x 60	50 Stk.
HS	40/22	M 12 x 80	50 Stk.
HS	40/22	M 12 x 100	50 Stk.
HS	40/22	M 12 x 150	50 Stk.
HS	40/22	M 12 x 200	25 Stk.
HS	40/22	M 16 x 30	50 Stk.
HS	40/22	M 16 x 40	50 Stk.
HS	40/22	M 16 x 50	50 Stk.
HS	40/22	M 16 x 60	25 Stk.
HS	40/22	M 16 x 80	25 Stk.
HS	40/22	M 16 x 100	25 Stk.
HS	40/22	M 16 x 125	25 Stk.
HS	40/22	M 16 x 150	25 Stk.
HS	40/22	M 16 x 250	25 Stk.

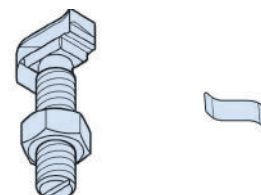
**HALFEN SCHRAUBE FEUERVERZINKT 8.8
GEZAHNT**

Typ	Bezeichnung	Gewinde	VPE
HZS	41/22	M 12 x 35	100 Stk.
HZS	41/22	M 12 x 50	100 Stk.
HZS	41/22	M 16 x 50	25 Stk.
HZS	41/22	M 16 x 100	25 Stk.

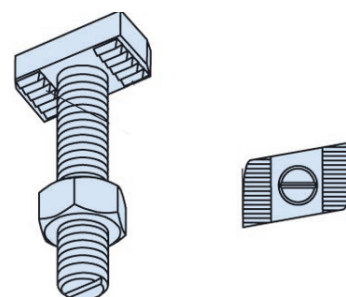

**HALFEN SCHRAUBE GALVANISCH VERZINKT 4.6
OHNE MUTTER**

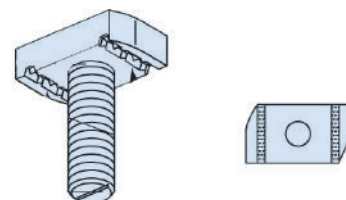
Typ	Bezeichnung	Gewinde
HZS	41/41	M 10 x 50
HZS	41/41	M 12 x 75

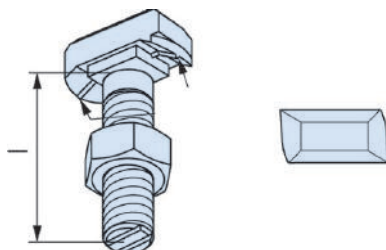

Wir erweitern ständig unser Lagerprogramm, nicht aufgeführte Abmessungen sind auf Anfrage lieferbar.

HALFEN SCHRAUBE GALVANISCH VERZINKT 4.6



Typ	Bezeichnung	Gewinde	VPE
HS	50/30	M 10 x 30	100 Stk.
HS	50/30	M 10 x 40	100 Stk.
HS	50/30	M 10 x 50	100 Stk.
HS	50/30	M 12 x 30	100 Stk.
HS	50/30	M 12 x 40	50 Stk.
HS	50/30	M 12 x 50	50 Stk.
HS	50/30	M 12 x 60	50 Stk.
HS	50/30	M 12 x 80	50 Stk.
HS	50/30	M 12 x 100	50 Stk.
HS	50/30	M 16 x 30	50 Stk.
HS	50/30	M 16 x 40	50 Stk.
HS	50/30	M 16 x 50	50 Stk.
HS	50/30	M 16 x 60	25 Stk.
HS	50/30	M 16 x 80	25 Stk.
HS	50/30	M 16 x 100	25 Stk.
HS	50/30	M 16 x 125	25 Stk.
HS	50/30	M 16 x 150	25 Stk.
HS	50/30	M 16 x 200	25 Stk.
HS	50/30	M 20 x 35	25 Stk.
HS	50/30	M 20 x 45	25 Stk.
HS	50/30	M 20 x 55	25 Stk.
HS	50/30	M 20 x 65	25 Stk.
HS	50/30	M 20 x 75	25 Stk.
HS	50/30	M 20 x 100	25 Stk.
HS	50/30	M 20 x 125	25 Stk.
HS	50/30	M 20 x 150	25 Stk.

HALFEN SCHRAUBE GALVANISCH VERZINKT 8.8

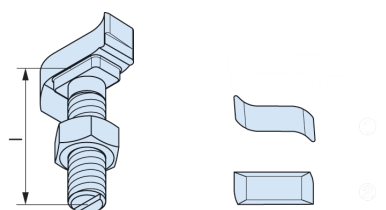

Typ	Bezeichnung	Gewinde	VPE
HS	40/22	M 16 x 60	25 Stk.
HS	40/22	M 16 x 80	25 Stk.
HS	50/30	M 12 x 45	25/50 Stk.
HS	50/30	M 12 x 80	25 Stk.
HS	50/30	M 16 x 40	50 Stk.
HS	50/30	M 16 x 60	25 Stk.
HS	50/30	M 16 x 80	10 Stk.
HS	50/30	M 16 x 100	25 Stk.
HS	50/30	M 20 x 45	25 Stk.
HS	50/30	M 20 x 80	25 Stk.
HS	50/30	M 20 x 100	10 Stk.

Wir erweitern ständig unser Lagerprogramm, nicht aufgeführte Abmessungen sind auf Anfrage lieferbar.

HALFEN SCHRAUBE MIT KERBZAHN VERZINKT

Typ	Bezeichnung	Gewinde	VPE
HSR	40/22	M 16 x 40 GV 8.8	50 Stk.
HSR	40/22	M 16 x 60 GV 8.8	25 Stk.
HSR	50/30	M 16 x 40 FV 8.8	50 Stk.
HSR	50/30	M 16 x 60 GV 8.8	25 Stk.
HSR	50/30	M 20 x 45 GV 8.8	25 Stk.
HSR	50/30	M 20 x 60 GV 8.8	25 Stk.
HSR	50/30	M 20 x 75 GV 8.8	25 Stk.

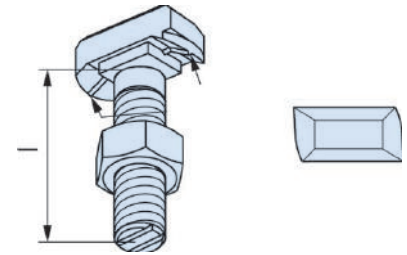

GV = galvanisch verzinkt
FV = feuerverzinkt

HALFEN SCHRAUBE FEUERVERZINKT

Typ	Bezeichnung	Gewinde	VPE
HS	28/15	M 10 x 30 FV 4.6	100 Stk.
HS	38/17	M 10 x 30 FV 4.6	100 Stk.
HS	38/17	M 12 x 30 FV 4.6	100 Stk.
HS	38/17	M 12 x 70 FV 8.8	50 Stk.
HS	38/17	M 16 x 30 FV 4.6	50 Stk.
HS	38/17	M 16 x 50 FV 4.6	50 Stk.
HS	38/17	M 16 x 60 FV 8.8	50 Stk.
HS	40/22	M 12 x 30 FV 4.6	100 Stk.
HS	40/22	M 12 x 50 FV 4.6	50 Stk.
HS	40/22	M 16 x 50 FV 4.6	50 Stk.
HS	50/30	M 12 x 40 FV 4.6	50 Stk.
HS	50/30	M 16 x 40 FV 4.6	50 Stk.
HS	50/30	M 16 x 50 FV 4.6	50 Stk.
HS	50/30	M 16 x 100 FV 4.6	25 Stk.
HS	72/48	M 20 x 50 FV 4.6	20 Stk.
HS	72/48	M 20 x 75 FV 4.6	20 Stk.
HS	72/48	M 20 x 100 FV 4.6	15 Stk.
HS	72/48	M 24 x 75 FV 4.6	15 Stk.

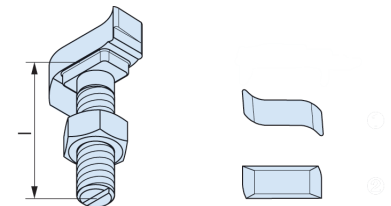

Wir erweitern ständig unser Lagerprogramm, nicht aufgeführte Abmessungen sind auf Anfrage lieferbar.

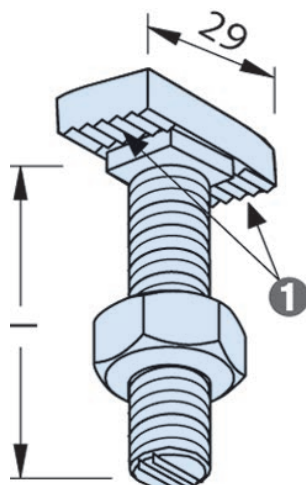

**HALFEN SCHRAUBE GALVANISCH VERZINKT 8.8
GEZAHNT DYNAGRIP**

Typ	Bezeichnung	Gewinde	VPE
HZS	29/20	M 12 x 30	100 Stk.
HZS	29/20	M 12 x 40	50 Stk.
HZS	29/20	M 12 x 50	50 Stk.
HZS	29/20	M 12 x 60	50 Stk.
HZS	38/23	M 12 x 30	100 Stk.
HZS	38/23	M 12 x 40	50 Stk.
HZS	38/23	M 12 x 50	50 Stk.
HZS	38/23	M 12 x 60	50 Stk.
HZS	38/23	M 16 x 50	50 Stk.
HZS	38/23	M 16 x 60	25 Stk.

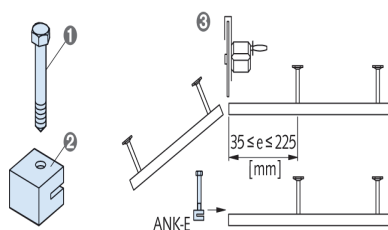

HALFEN ENDANKER FEUERVERZINKT

Typ	Bezeichnung	VPE
ANK-E1	28/15	25 Stk.
ANK-E2	38/17 und 40/22	25 Stk.

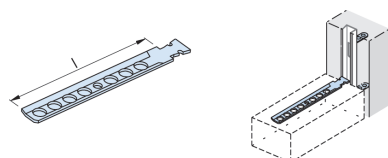

**HALFEN SCHRAUBE GALVANISCH VERZINKT 8.8
FEUERVERZINKT**

Typ	Bezeichnung	VPE
ML 85	für 28/15	200 Stk.
ML 120	für 28/15	200 Stk.
ML 180	für 28/15	200 Stk.
BL 85	für 38/17	200 Stk.
BL 120	für 38/17	200 Stk.
BL 180	für 38/17	200 Stk.

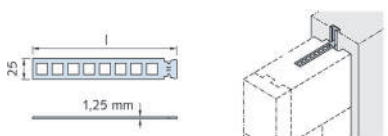

**HALFEN MAUERANSCHLUSSANKER
EDELSTAHL 1.4301 (A2)**

Für Dünnbettmörtel
Für Profil 28/15

Typ	Länge	VPE
ML1	125 mm	100/200 Stk.
ML1	185 mm	100 Stk.
ML1	245 mm	100 Stk.

Wir erweitern ständig unser Lagerprogramm, nicht aufgeführte Abmessungen sind auf Anfrage lieferbar.

**HALFEN NAGELANSCHLUSSANKER
FEUERVERZINKT**

Typ	Bezeichnung	VPE
N 95	für 28/15	150 Stk.
N 120	für 28/15	150 Stk.
BN 120	für 38/17	150 Stk.
BN 185	für 38/17	150 Stk.

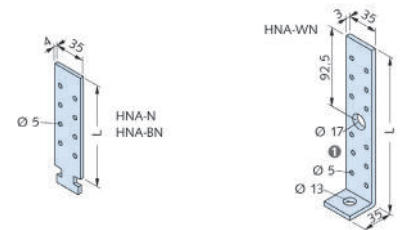

HALFEN SPARRENFUSS FEUERVERZINKT

Typ	Bezeichnung
HSF	6/12

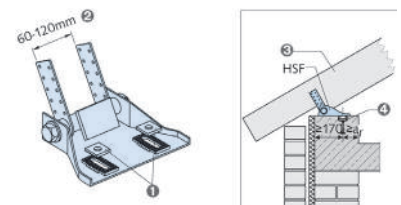

Wir erweitern ständig unser Lagerprogramm, nicht aufgeführte Abmessungen sind auf Anfrage lieferbar.

M 6, M 8:

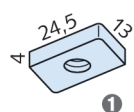

M 10:

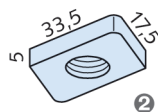

HALFEN GEWINDEPLATTE GALVANISCH VERZINKT

Typ	Bezeichnung	Gewinde	VPE
GWP	20/12	M 5	200 Stk.
GWP	20/12	M 6	200 Stk.
GWP	28/15	M 6	200 Stk.
GWP	28/15	M 8	200 Stk.
GWP	28/15	M 10	200 Stk.
GWP	38/17	M 6	100 Stk.
GWP	38/17	M 8	100 Stk.
GWP	38/17	M 10	100 Stk.
GWP	38/17	M 12	100 Stk.
GWP	40/22	M 6	100 Stk.
GWP	40/22	M 8	100 Stk.
GWP	40/22	M 10	100 Stk.
GWP	40/22	M 12	100 Stk.
GWP	41/22	M 6	100 Stk.
GWP	41/22	M 8	100 Stk.
GWP	41/22	M 10	100 Stk.
GWP	41/22	M 12	100 Stk.
GWP	41/22	M 16	100 Stk.
GWP	41/41	M 6	100 Stk.
GWP	41/41	M 8	100 Stk.
GWP	41/41	M 10	100 Stk.
GWP	41/41	M 12	100 Stk.
GWP	41/41	M 16	100 Stk.
GWP	50/30	M 8	100 Stk.
GWP	50/30	M 10	100 Stk.
GWP	50/30	M 12	100 Stk.
GWP	50/30	M 16	100 Stk.
GWP	50/40	M 6	100 Stk.
GWP	50/40	M 8	100 Stk.
GWP	50/40	M 10	100 Stk.
GWP	50/40	M 12	100 Stk.
GWP	50/40	M 16	100 Stk.
GWP	72/48	M 12	50 Stk.
GWP	72/48	M 16	50 Stk.
GWP	72/48	M 20	50 Stk.

HALFEN KLEMMPLATTE FEUERVERZINKT

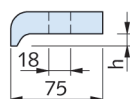
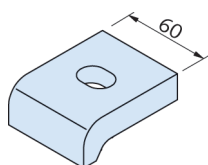

Typ	Bezeichnung
KLP	60/10
KLP	60/12
KLP	60/14
KLP	60/16
KLP	60/18
KLP	60/20

Wir erweitern ständig unser Lagerprogramm, nicht aufgeführte Abmessungen sind auf Anfrage lieferbar.

HALFEN DÜBELLEISTE

Typ	Bezeichnung	Maß-Kette
HDB	10/125-2/200	50/100/50
HDB	10/125-3/300	50/2x100/50
HDB	10/135-2/200	50/100/50
HDB	10/135-3/300	50/2x100/50
HDB	10/145-2/200	50/100/50
HDB	10/145-3/300	50/2x100/50
HDB	10/155-2/220	55/110/55
HDB	10/155-3-330	55/2x110/55
HDB	10/165-2/240	60/120/60
HDB	10/165-3/360	60/2x120/60
HDB	10/175-2/240	60/120/60
HDB	10/175-3/360	60/2x120/60
HDB	10/185-2/280	70/140/70
HDB	10/185-3/420	70/2x140/70
HDB	10/195-2/280	70/140/70
HDB	10/195-3/420	70/2x140/70
HDB	10/205-2/280	70/140/70
HDB	10/205-3/420	70/2x140/70
HDB	10/215-2/300	75/150/75
HDB	10/215-3/450	75/2x150/75
HDB	12/155-2/220	55/110/55
HDB	12/155-3/330	55/2x110/55
HDB	12/165-2/240	60/120/60
HDB	12/165-3/360	60/2x120/60
HDB	12/175-2/240	60/120/60
HDB	12/175-3/360	60/2x120/60
HDB	12/185-2/280	70/140/70
HDB	12/185-3/420	70/2x140/70
HDB	12/195-2/280	70/140/70
HDB	12/195-3/420	70/2x140/70
HDB	12/205-2/280	70/140/70
HDB	12/205-3/420	70/2x140/70
HDB	12/215-2/300	75/150/75
HDB	12/215-3/450	75/2x150/75
HDB	12/225-2/320	80/160/80
HDB	12/225-3/480	80/2x160/80
HDB	12/235-2/340	85/170/85
HDB	12/235-3/510	85/2x170/85

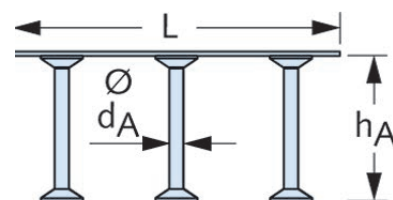
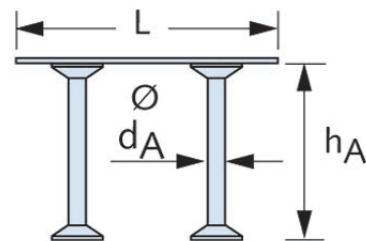

■ HALFEN DÜBELLEISTE

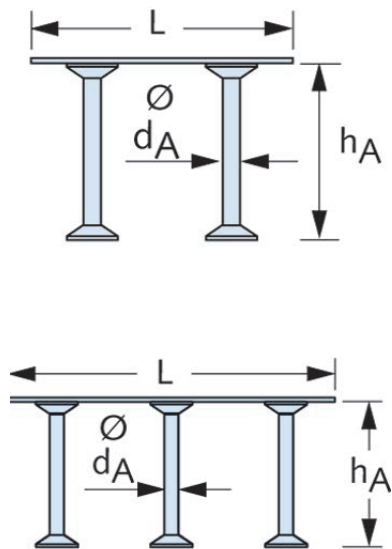

Typ	Bezeichnung	Maß-Kette
HDB	14/155-2/220	55/110/55
HDB	14/155-3/330	55/2x110/55
HDB	14/175-2/240	60/120/60
HDB	14/175-3/360	60/2x120/60
HDB	14/185-2/280	70/140/70
HDB	14/185-3/420	70/2x140/70
HDB	14/195-2/280	70/140/70
HDB	14/195-3/420	70/2x140/70
HDB	14/205-2/280	70/140/70
HDB	14/205-3/420	70/2x140/70
HDB	14/215-2/300	75/150/75
HDB	14/215-3/450	75/2x150/75
HDB	14/225-2/320	80/160/80
HDB	14/225-3/480	80/2x160/80
HDB	14/235-2/340	85/170/85
HDB	14/235-3/510	85/2x170/85
HDB	14/245-2/360	90/180/90
HDB	14/245-3/540	90/2x180/90
HDB	14/255-2/360	90/180/90
HDB	14/255-3/540	90/2x180/90
HDB	14/265-2/400	100/200/100
HDB	14/265-3/600	100/2x200/100
HDB	16/205-2/280	70/140/70
HDB	16/205-3/420	70/2x140/70
HDB	16/215-2/300	75/150/75
HDB	16/215-3/450	75/2x150/75
HDB	16/235-2/340	85/170/85
HDB	16/235-3/510	85/2x170/85
HDB	16/245-2/360	90/180/90
HDB	16/245-3/540	90/2x180/90
HDB	16/255-2/360	90/180/90
HDB	16/255-3/540	90/2x180/90
HDB	16/265-2/400	100/200/100
HDB	16/265-3/600	100/2x200/100
HDB	16/275-2/400	100/200/100
HDB	16/275-3/600	100/2x200/100
HDB	16/285-2/420	105/210/105
HDB	16/285-3/630	105/2x210/105
HDB	20/235-2/340	85/170/85
HDB	20/235-3/510	85/2x170/85
HDB	20/245-2/360	90/180/90
HDB	20/245-3/540	90/2x180/90
HDB	20/255-2/360	90/180/90
HDB	20/255-3/540	90/2x180/90
HDB	20/265-2/400	100/200/100
HDB	20/265-3/600	100/2x200/100

Wir erweitern ständig unser Lagerprogramm, nicht aufgeführte Abmessungen sind auf Anfrage lieferbar.

HALFEN ABSTANDHALTER

Typ	Höhe mm
HDB	20 mm
HDB	25 mm
HDB	30 mm
HDB	35 mm

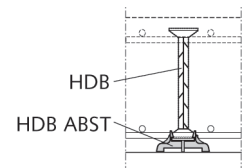

HALFEN KLEMMBÜGEL
FÜR DEN EINBAU VON OBEN

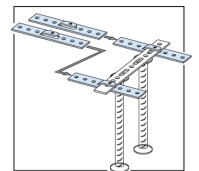
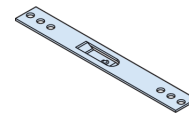
Typ
HDB

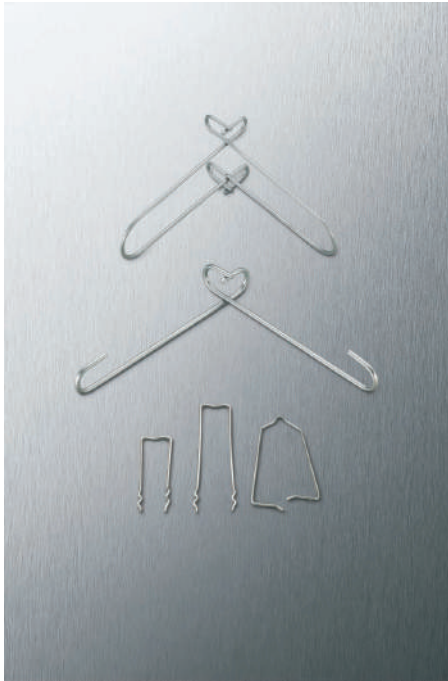

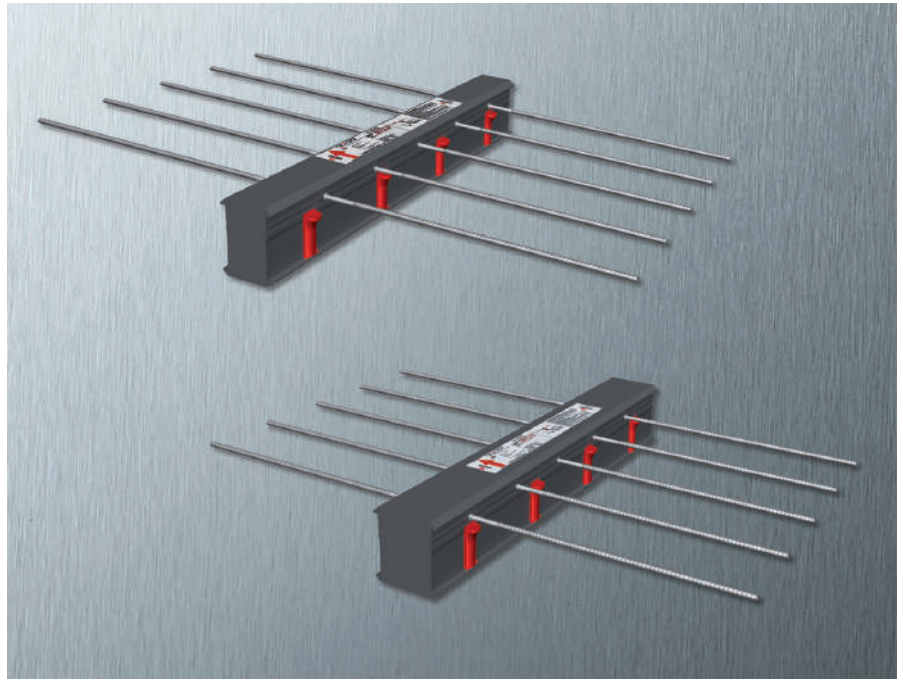

HALFEN Sandwichplatten-Traganker



HALFEN HIT Iso-Elemente HIT-HP MV und HIT-SP MV



HALFEN HDB Durchstanzbewehrung



HALFEN SP-MVA Manschetten-Verbundanker

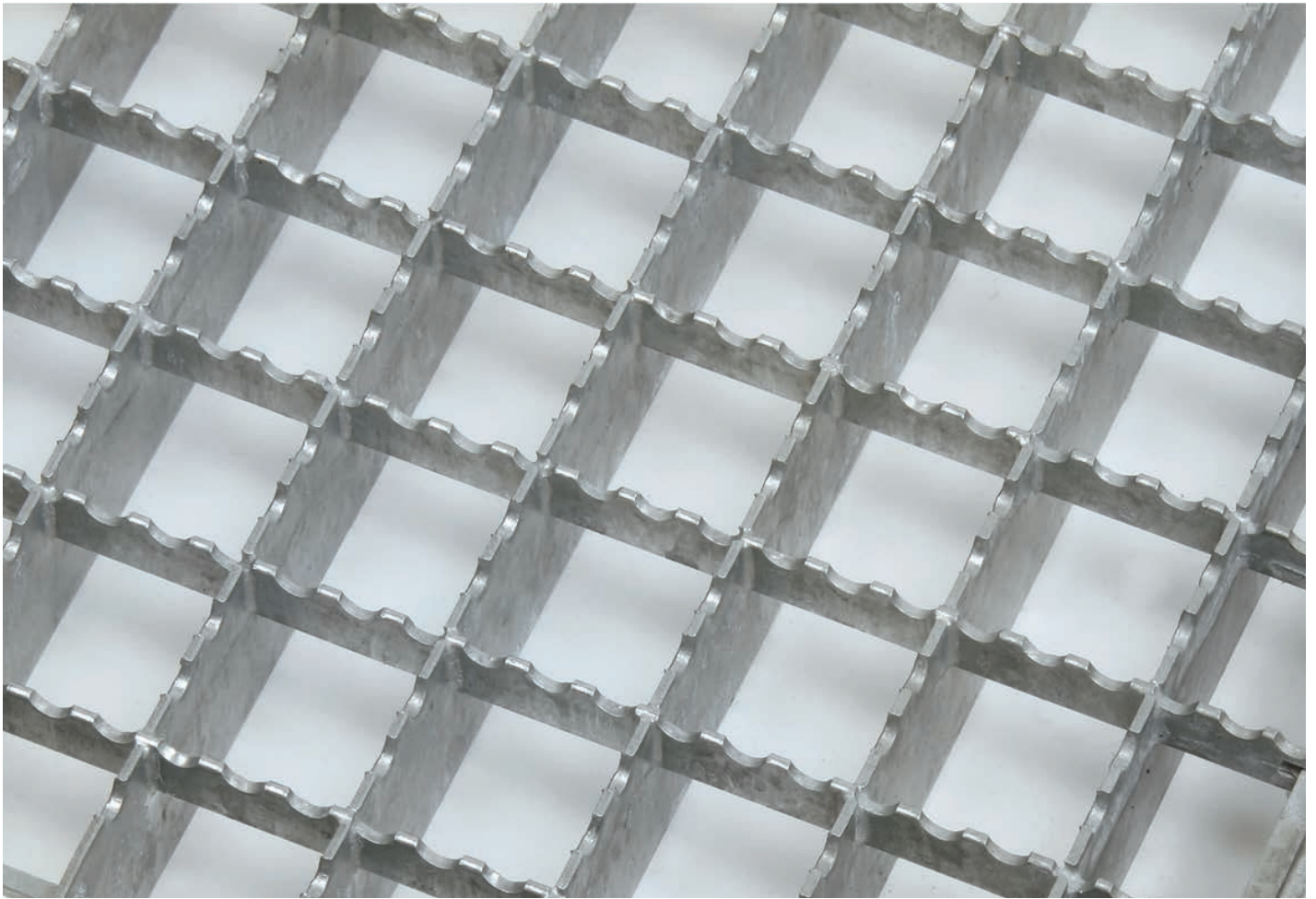

GITTERROSTE

■ **FACHBEGRIFFE**

■ **TRAGSTÄBE**

Tragstäbe sind belastungsaufnehmende, senkrecht stehende Flacheisen, welche in parallelem Abstand zueinander von Auflage zu Auflage verlaufen.



■ **FÜLLSTÄBE**

Die Füllstäbe verlaufen quer zu den Tragstäben und verbinden diese miteinander, indem sie an den Kreuzungspunkten verpreßt bzw. verschweißt werden.

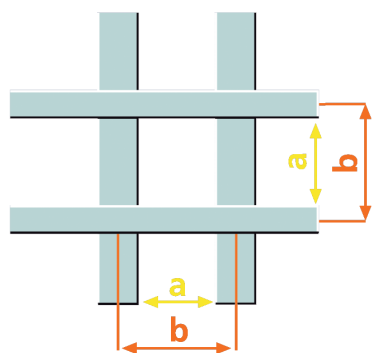

■ **MASCHENWEITE**

Lichtes Maß (a) jeweils zwischen Trag- und Füllstäben

■ **MASCHENTEILUNG**

Das Maß von Mitte zu Mitte (b) jeweils bei Trag- und Füllstäben

■ **RANDEINFASSUNG**

Die Roste werden in der Regel rundum eingefasst.
Einfassung aus: Flacheisen, T-Profil oder U-Profil.

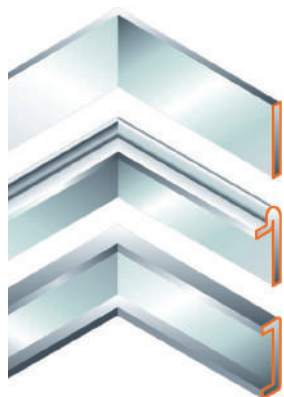

■ STÜTZWEITE (TRAGSTABRICHTUNG)

Tragstäbe liegen von Rostauflage zu Rostauflage und tragen die Belastung.
Tragstabenden sollten mindestens 30 mm aufliegen.

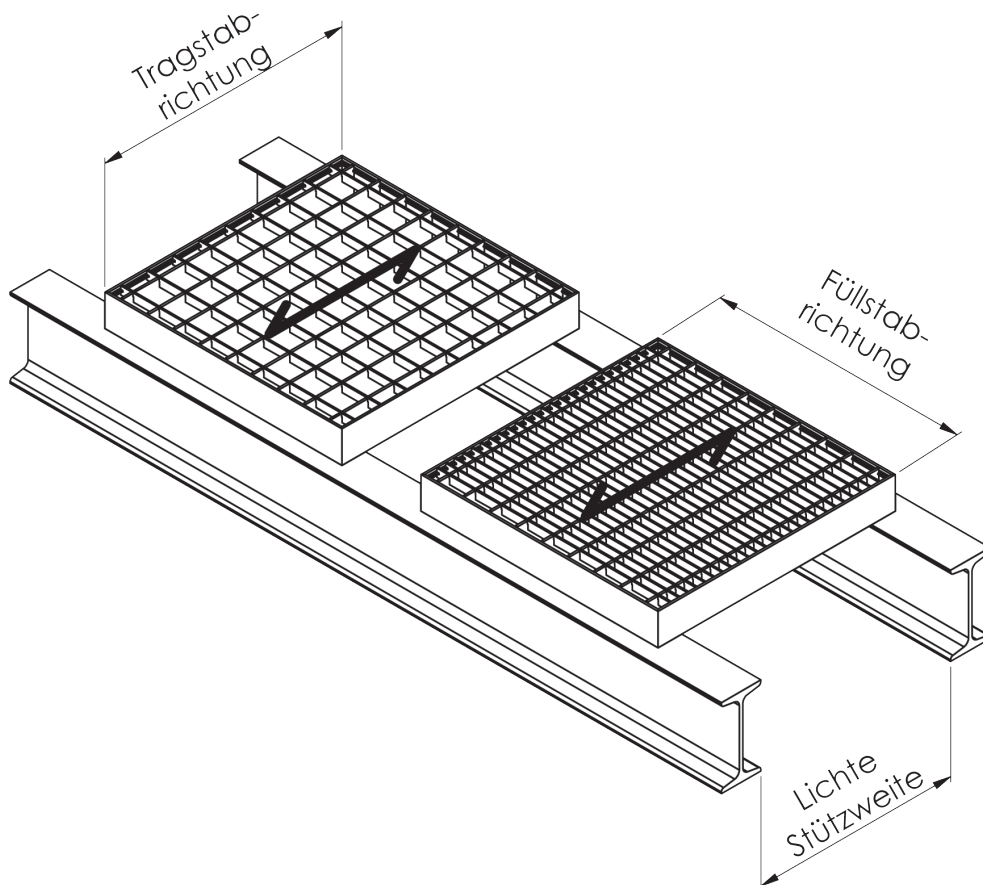

BAU-NORMROSTE TYP P

Abmessung = Rahmenaußenmaß, Roste in Länge und Breite 10 mm kleiner als Rahmenaußenmaße, erstgenanntes Maß = Tragstabrichtung
Einfassung T-Profile bzw. U-Profile, feuerverzinkt, mit oder ohne Rahmen

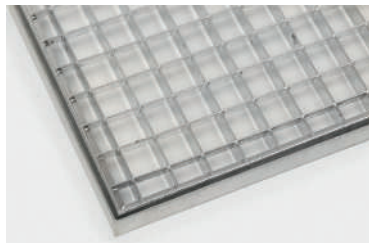

Bauhöhe	Abmessung	Maschenweite
20 mm	300 x 500 mm	30 x 30 mm
20 mm	300 x 600 mm	30 x 30 mm
20 mm	350 x 500 mm	30 x 30 mm
20 mm	400 x 600 mm	30 x 30 mm
20 mm	400 x 700 mm	30 x 30 mm
20 mm	400 x 800 mm	30 x 30 mm
20 mm	400 x 900 mm	30 x 30 mm
20 mm	400 x 1000 mm	30 x 30 mm
20 mm	400 x 1100 mm	30 x 30 mm
20 mm	400 x 1200 mm	30 x 30 mm
20 mm	500 x 800 mm	30 x 30 mm
20 mm	500 x 900 mm	30 x 30 mm
20 mm	500 x 1000 mm	30 x 30 mm
20 mm	500 x 1100 mm	30 x 30 mm
20 mm	600 x 1000 mm	30 x 30 mm
20 mm	600 x 1200 mm	30 x 30 mm

BAU-NORMROSTE TYP P

Abmessung = Rahmenaußenmaß, Roste in Länge und Breite 10 mm kleiner als Rahmenaußenmaße, erstgenanntes Maß = Tragstabrichtung
Einfassung T-Profile bzw. U-Profile, feuerverzinkt, mit oder ohne Rahmen

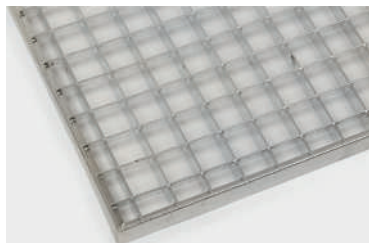

Bauhöhe	Abmessung	Maschenweite
25 mm	500 x 700 mm	30 x 30 mm
25 mm	500 x 800 mm	30 x 30 mm
25 mm	500 x 900 mm	30 x 30 mm
25 mm	500 x 1000 mm	30 x 30 mm
25 mm	500 x 1100 mm	30 x 30 mm
25 mm	500 x 1200 mm	30 x 30 mm
25 mm	600 x 800 mm	30 x 30 mm
25 mm	600 x 900 mm	30 x 30 mm
25 mm	600 x 1000 mm	30 x 30 mm
25 mm	600 x 1200 mm	30 x 30 mm
25 mm	800 x 500 mm	30 x 30 mm
25 mm	900 x 500 mm	30 x 30 mm

Wir erweitern ständig unser Lagerprogramm, nicht aufgeführte Abmessungen sind auf Anfrage lieferbar.

■ BAU-NORMROSTE TYP P

Abmessung = Rahmenaußenmaß, Roste in Länge und Breite 10 mm kleiner als Rahmenaußenmaße, erstgenanntes Maß = Tragstabrichtung
Einfassung T-Profile bzw. U-Profile, feuerverzinkt, mit oder ohne Rahmen

Bauhöhe	Abmessung	Maschenweite
30 mm	500 x 1200 mm	30 x 30 mm
30 mm	600 x 1200 mm	30 x 30 mm
30 mm	1000 x 500 mm	30 x 30 mm
30 mm	1000 x 600 mm	30 x 30 mm
30 mm	1100 x 500 mm	30 x 30 mm
30 mm	1100 x 600 mm	30 x 30 mm
30 mm	1200 x 400 mm	30 x 30 mm
30 mm	1200 x 500 mm	30 x 30 mm
30 mm	1200 x 600 mm	30 x 30 mm

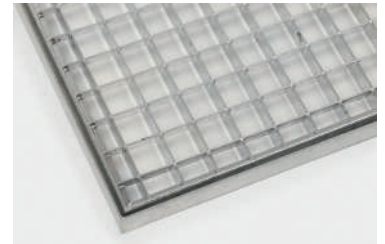

■ BAU-NORMROSTE TYP P

Abmessung = Rahmenaußenmaß, Roste in Länge und Breite 10 mm kleiner als Rahmenaußenmaße, erstgenanntes Maß = Tragstabrichtung
Einfassung T-Profile bzw. U-Profile, feuerverzinkt, mit oder ohne Rahmen

Bauhöhe	Abmessung	Maschenweite
20 mm	300 x 600 mm	30 x 10 mm
20 mm	350 x 500 mm	30 x 10 mm
20 mm	400 x 600 mm	30 x 10 mm
20 mm	400 x 700 mm	30 x 10 mm
20 mm	400 x 800 mm	30 x 10 mm
20 mm	400 x 900 mm	30 x 10 mm
20 mm	400 x 1000 mm	30 x 10 mm
20 mm	400 x 1100 mm	30 x 10 mm
20 mm	400 x 1200 mm	30 x 10 mm
20 mm	500 x 800 mm	30 x 10 mm
20 mm	500 x 900 mm	30 x 10 mm
20 mm	500 x 1000 mm	30 x 10 mm
20 mm	500 x 1100 mm	30 x 10 mm
20 mm	500 x 1200 mm	30 x 10 mm
20 mm	600 x 1000 mm	30 x 10 mm
20 mm	600 x 1200 mm	30 x 10 mm

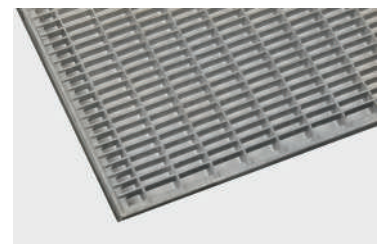

■ BAU-NORMROSTE TYP P

Abmessung = Rahmenaußenmaß, Roste in Länge und Breite 10 mm kleiner als Rahmenaußenmaße, erstgenanntes Maß = Tragstabrichtung

Einfassung T-Profil bzw. U-Profil, feuerverzinkt, mit oder ohne Rahmen

Bauhöhe	Abmessung	Maschenweite
25 mm	500 x 700 mm	30 x 10 mm
25 mm	500 x 800 mm	30 x 10 mm
25 mm	500 x 900 mm	30 x 10 mm
25 mm	500 x 1000 mm	30 x 10 mm
25 mm	500 x 1100 mm	30 x 10 mm
25 mm	500 x 1200 mm	30 x 10 mm
25 mm	600 x 800 mm	30 x 10 mm
25 mm	600 x 900 mm	30 x 10 mm
25 mm	600 x 1000 mm	30 x 10 mm
25 mm	600 x 1200 mm	30 x 10 mm
25 mm	800 x 500 mm	30 x 10 mm

■ BAU-NORMROSTE TYP P

Abmessung = Rahmenaußenmaß, Roste in Länge und Breite 10 mm kleiner als Rahmenaußenmaße, erstgenanntes Maß = Tragstabrichtung

Einfassung T-Profil bzw. U-Profil, feuerverzinkt, mit oder ohne Rahmen

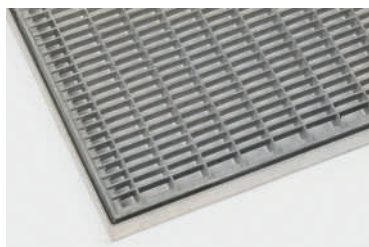

Bauhöhe	Abmessung	Maschenweite
30 mm	1000 x 500 mm	30 x 10 mm
30 mm	1000 x 600 mm	30 x 10 mm
30 mm	1200 x 500 mm	30 x 10 mm
30 mm	1200 x 600 mm	30 x 10 mm

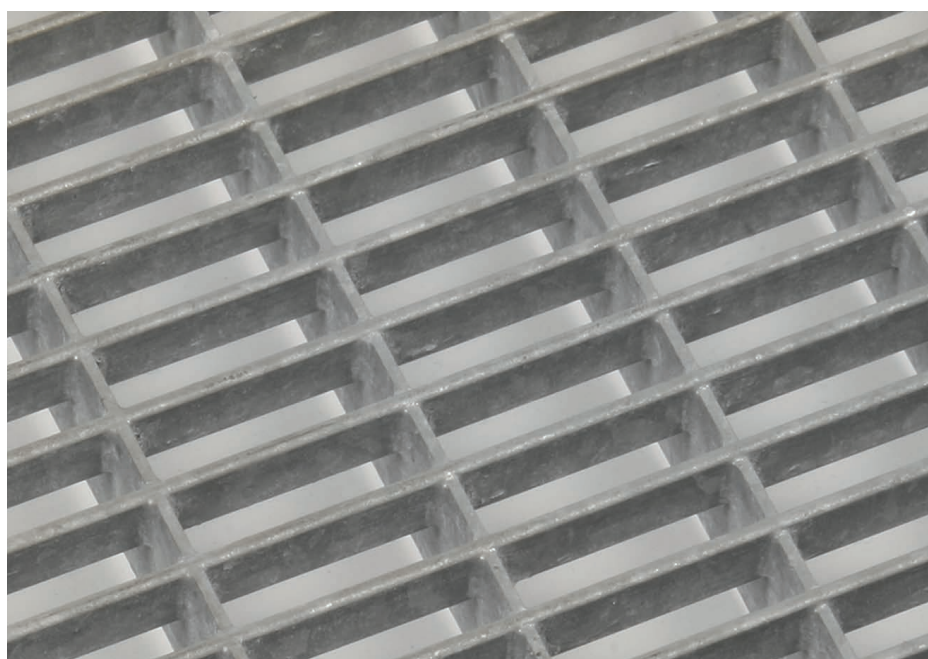

Wir erweitern ständig unser Lagerprogramm, nicht aufgeführte Abmessungen sind auf Anfrage lieferbar.

■ PRESS-INDUSTRIEROSTE

Abmessung = Rostaußenmaß, erstgenanntes Maß = Tragstabrichtung
Einfassung T-Profile, feuerverzinkt, ohne Rahmen

Art.Nr.	Tragstab	Abmessung	Maschenweite
3520010143	30 x 2 mm	500 x 1000 mm	30 x 30 mm
3520010145	30 x 2 mm	600 x 1000 mm	30 x 30 mm
3520010146	30 x 2 mm	700 x 1000 mm	30 x 30 mm
3520010093	30 x 2 mm	800 x 500 mm	30 x 30 mm
3520010170	30 x 2 mm	800 x 800 mm	30 x 30 mm
3520010043	30 x 2 mm	800 x 1000 mm	30 x 30 mm
3520010147	30 x 2 mm	900 x 1000 mm	30 x 30 mm
3520010142	30 x 2 mm	1000 x 500 mm	30 x 30 mm
3520010039	30 x 2 mm	1000 x 600 mm	30 x 30 mm
3520010044	30 x 2 mm	1000 x 800 mm	30 x 30 mm
3520010045	30 x 2 mm	1000 x 1000 mm	30 x 30 mm
3520010150	30 x 2 mm	1000 x 1200 mm	30 x 30 mm
3520010047	30 x 2 mm	1000 x 1250 mm	30 x 30 mm
3520010048	30 x 2 mm	1000 x 1500 mm	30 x 30 mm
3520010130	30 x 3 mm	1000 x 1000 mm	30 x 30 mm
3520010175	30 x 3 mm	1200 x 500 mm	30 x 30 mm
3520010176	30 x 3 mm	1200 x 600 mm	30 x 30 mm
3520010046	30 x 3 mm	1200 x 1000 mm	30 x 30 mm
3520010174	30 x 2 mm	800 x 800 mm	30 x 10 mm
3520010151	30 x 2 mm	800 x 1000 mm	30 x 10 mm
3520010172	30 x 2 mm	1000 x 500 mm	30 x 10 mm
3520010173	30 x 2 mm	1000 x 600 mm	30 x 10 mm
3520010091	30 x 2 mm	1000 x 1000 mm	30 x 10 mm
3520010166	30 x 2 mm	1200 x 1000 mm	30 x 10 mm
3520010177	30 x 3 mm	1200 x 500 mm	30 x 10 mm
3520010178	30 x 3 mm	1200 x 600 mm	30 x 10 mm

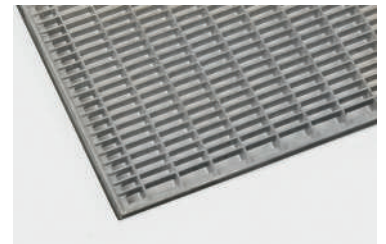

■ PRESS-GLEITSCHUTZ-INDUSTRIEROSTE

Abmessung = Rostaußenmaß, erstgenanntes Maß = Tragstabrichtung
Einfassung T-Profile, feuerverzinkt, ohne Rahmen

Tragstab	Abmessung	Maschenweite
30 x 2 mm	800 x 1000 mm	30 x 30 mm**
30 x 2 mm	800 x 1000 mm	30 x 10 mm*
30 x 2 mm	900 x 1000 mm	30 x 30 mm**
30 x 3 mm	1000 x 1000 mm	30 x 30 mm**
30 x 2 mm	1000 x 1000 mm	30 x 10 mm*
30 x 3 mm	1200 x 1000 mm	30 x 30 mm**

** = mit halbrund ausgeklinkten Trag- und Füllstäben

* = mit halbrund ausgeklinkten Füllstäben

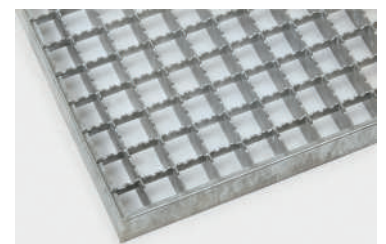

■ SCHWEISSPRESS-INDUSTRIEROSTE

Mit verdrehten Vierkant-Stäben
Abmessung = Rostaußenmaß, erstgenanntes Maß = Tragstabrichtung
Einfassung Flach-Profile, feuerverzinkt, ohne Rahmen

Art.Nr.	Tragstab	Abmessung	Maschenweite
3520010163	30 x 3 mm	800 x 1000 mm	30 x 30 mm
3520010164	30 x 3 mm	900 x 1000 mm	30 x 30 mm
3520010165	30 x 3 mm	1000 x 1000 mm	30 x 30 mm



Wir erweitern ständig unser Lagerprogramm, nicht aufgeführte Abmessungen sind auf Anfrage lieferbar.

■ PRESS-INDUSTRIEROST-STUFEN

Mit Laschen und Sicherheitsantrittskante, feuerverzinkt
Erstgenanntes Maß = Tragstabrichtung

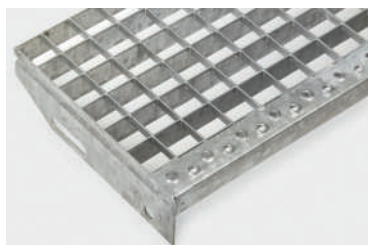

Tragstab	Abmessung	Maschenweite	Bohrung
30 x 2 mm	600 x 240 mm	30 x 30 mm	120 mm
30 x 2 mm	600 x 270 mm	30 x 30 mm	150 mm
30 x 2 mm	700 x 240 mm	30 x 30 mm	120 mm
30 x 2 mm	700 x 270 mm	30 x 30 mm	150 mm
30 x 2 mm	800 x 240 mm	30 x 30 mm	120 mm
30 x 2 mm	800 x 270 mm	30 x 30 mm	150 mm

■ PRESS-INDUSTRIEROST-STUFEN

Mit Laschen und Sicherheitsantrittskante, feuerverzinkt
Erstgenanntes Maß = Tragstabrichtung



Tragstab	Abmessung	Maschenweite	Bohrung
30 x 3 mm	800 x 305 mm	30 x 30 mm	180 mm
30 x 3 mm	900 x 305 mm	30 x 30 mm	180 mm
35 x 2 mm	900 x 240 mm	30 x 30 mm	120 mm
35 x 2 mm	900 x 270 mm	30 x 30 mm	150 mm
35 x 2 mm	1000 x 240 mm	30 x 30 mm	120 mm
35 x 2 mm	1000 x 270 mm	30 x 30 mm	150 mm
40 x 3 mm	1000 x 305 mm	30 x 30 mm	180 mm
40 x 3 mm	1200 x 270 mm	30 x 30 mm	150 mm
40 x 3 mm	1200 x 305 mm	30 x 30 mm	180 mm

■ PRESS-INDUSTRIEROST-STUFEN

Mit Laschen und Sicherheitsantrittskante, feuerverzinkt
Erstgenanntes Maß = Tragstabrichtung



Tragstab	Abmessung	Maschenweite	Bohrung
30 x 2 mm	600 x 270 mm	30 x 10 mm	150 mm
30 x 2 mm	700 x 270 mm	30 x 10 mm	150 mm
30 x 2 mm	800 x 240 mm	30 x 10 mm	120 mm
30 x 2 mm	800 x 270 mm	30 x 10 mm	150 mm
35 x 2 mm	900 x 270 mm	30 x 10 mm	150 mm
35 x 2 mm	1000 x 240 mm	30 x 10 mm	120 mm
35 x 2 mm	1000 x 270 mm	30 x 10 mm	150 mm
30 x 3 mm	1000 x 305 mm	30 x 10 mm	180 mm
40 x 3 mm	1200 x 270 mm	30 x 10 mm	150 mm
40 x 3 mm	1200 x 305 mm	30 x 10 mm	180 mm

Wir erweitern ständig unser Lagerprogramm, nicht aufgeführte Abmessungen sind auf Anfrage lieferbar.

■ PRESS-GLEITSCHUTZ-INDUSTRIEROST-STUFEN

Mit Laschen und Sicherheitsantrittskante, feuerverzinkt
Erstgenanntes Maß = Tragstabrichtung

Art.Nr.	Tragstab	Abmessung	Maschenweite	Bohrung
3520020032	30 x 2 mm	800 x 270 mm	30 x 30 mm**	150 mm
3520020061	30 x 2 mm	800 x 270 mm	30 x 10 mm *	150 mm
3520020034	30 x 3 mm	1000 x 270 mm	30 x 30 mm**	150 mm
3520020042	35 x 2 mm	900 x 270 mm	30 x 30 mm**	150 mm
3520020062	35 x 2 mm	1000 x 270 mm	30 x 10 mm *	150 mm
3520020069	40 x 2 mm	1000 x 305 mm	30 x 30 mm**	180 mm
3520020035	40 x 3 mm	1200 x 270 mm	30 x 30 mm**	150 mm
3520020067	40 x 3 mm	1200 x 305 mm	30 x 10 mm *	180 mm
3520020058	40 x 3 mm	1200 x 305 mm	30 x 30 mm**	180 mm
3520020068	40 x 3 mm	1200 x 270 mm	30 x 10 mm *	150 mm

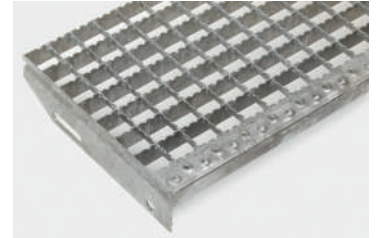

■ SCHWEISSPRESS-INDUSTRIEROST-STUFEN

** = mit halbrund ausgeklinkten Trag- und Füllstäben

* = mit halbrund ausgeklinkten Füllstäben

Mit verdrehten Vierkant-Stäben
Mit Laschen und Sicherheitsantrittskante, feuerverzinkt
Erstgenanntes Maß = Tragstabrichtung

Tragstab	Abmessung	Maschenweite	Bohrung
30 x 3 mm	800 x 270 mm	30 x 30 mm	150 mm
30 x 3 mm	900 x 270 mm	30 x 30 mm	150 mm
30 x 3 mm	1000 x 270 mm	30 x 30 mm	150 mm



■ BOHRLOCHSKIZZE

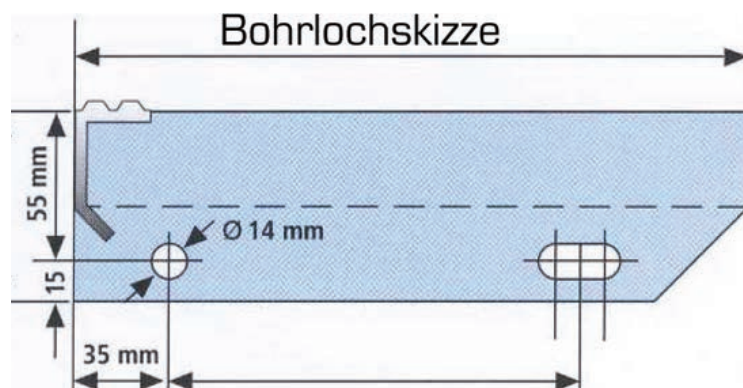

Wir erweitern ständig unser Lagerprogramm, nicht aufgeführte Abmessungen sind auf Anfrage lieferbar.

■ PRESSROST-MATTE

Ohne Randeinfassung, unverzinkt (roh)
Erstgenanntes Maß = Tragstabrichtung

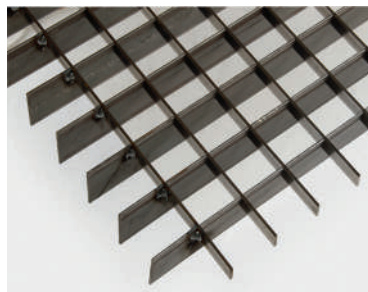

Tragstab	Abmessung	Maschenweite
30 x 2 mm	2350 x 1500 mm	30 x 30 mm
30 x 2 mm	2400 x 1200 mm	30 x 30 mm
30 x 2 mm	3000 x 1000 mm	30 x 30 mm
30 x 2 mm	2350 x 1500 mm	30 x 10 mm
30 x 2 mm	2400 x 1200 mm	30 x 10 mm
30 x 2 mm	3000 x 1000 mm	30 x 10 mm
30 x 3 mm	3000 x 1000 mm	30 x 30 mm
30 x 3 mm	3000 x 1000 mm	30 x 10 mm
40 x 3 mm	3000 x 1000 mm	30 x 30 mm
40 x 3 mm	3000 x 1000 mm	30 x 10 mm

■ PRESSROST-GLEITSCHUTZ-MATTE

Ohne Randeinfassung, unverzinkt (roh).
Erstgenanntes Maß = Tragstabrichtung.

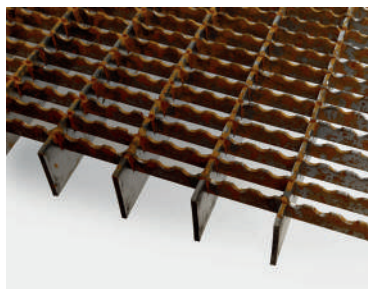

Tragstab	Abmessung	Maschenweite
30 x 3 mm	3000 x 1000 mm	30 x 30 mm **
30 x 3 mm	3000 x 1000 mm	30 x 10 mm *

** = mit halbrund ausgeklinkten Trag- und Füllstäben
* = mit halbrund ausgeklinkten Füllstäben

Wir erweitern ständig unser Lagerprogramm, nicht aufgeführte Abmessungen sind auf Anfrage lieferbar.

■ PRESSROST-MATTE

Ohne Randeinfassung, Edelstahl 1.4301 (V2A) ungebeizt
Erstgenanntes Maß = Tragstabrichtung

Tragstab	Abmessung	Maschenweite
30 x 2 mm	3000 x 1000 mm	30 x 30 mm

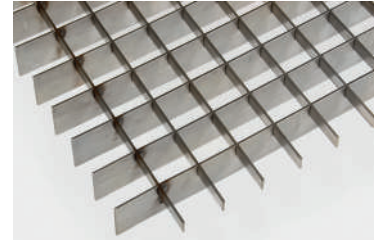

■ PRESSROST-GLEITSCHUTZ-MATTE

Ohne Randeinfassung, Edelstahl 1.4301 (V2A) ungebeizt
Erstgenanntes Maß = Tragstabrichtung

Tragstab	Abmessung	Maschenweite
30 x 3 mm	3000 x 1000 mm	30 x 30 mm **



** = mit halbrund ausgeklinkten Trag- und Füllstäben

■ SCHWEISSPRESS-MATTE

Mit verdrillten Vierkant-Stäben
Kurzseiten ohne Einfassung, unverzinkt (roh), Längsseiten besäumt
Erstgenanntes Maß = Tragstabrichtung

Tragstab	Abmessung	Maschenweite
25 x 2 mm	6100 x 1000 mm	30 x 30 mm
30 x 2 mm	6100 x 1000 mm	30 x 30 mm
30 x 3 mm	6100 x 1000 mm	30 x 30 mm
30 x 3 mm	6100 x 1000 mm	30 x 15 mm
40 x 3 mm	6100 x 1000 mm	30 x 30 mm

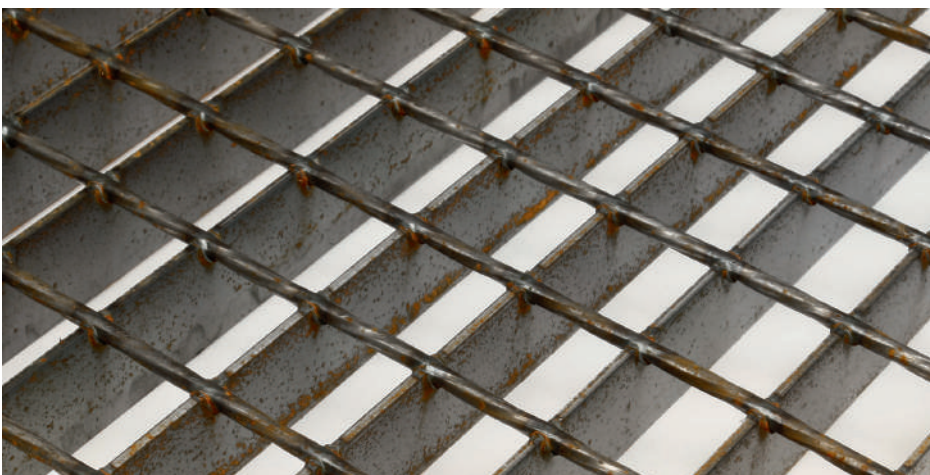
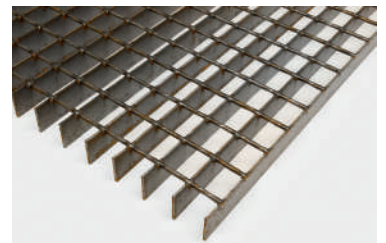

Wir erweitern ständig unser Lagerprogramm, nicht aufgeführte Abmessungen sind auf Anfrage lieferbar.

■ **SICHERHEITSANTRITTSKANTE**

Gelocht, unverzinkt (roh)



Abmessung mm	Länge mm
34 x 29 x 2.0	6000

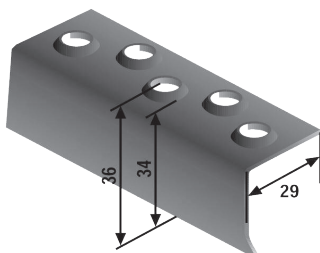

■ **LEITERSPROSSENPROFILE**



Bezeichnung	Abmessung mm	Länge mm	Werkstoff
Quadr. längsgerieft parallel an 2 Seiten	25/25/1.5	6150	Stahl unverzinkt (roh)
U-Profil einreihiges Lochbild	35/34/2.0	2000	Stahl unverzinkt (roh)
U-Profil einreihiges Lochbild	35/34/2.0	2000	Edelstahl 1.4301 roh (ungebeizt)
U-Profil zweireihiges Lochbild	50/39/2.0	2000	Stahl unverzinkt (roh)

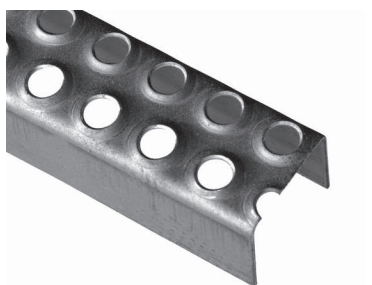

Wir erweitern ständig unser Lagerprogramm, nicht aufgeführte Abmessungen sind auf Anfrage lieferbar.

■ SICHERUNGSKETTEN FÜR GITTERROSTE

Komplett
Im Folienbeutel 2 Stück = 1 Paar

Werkstoff	Länge
feuerverzinkt	70 cm



■ STANDARD-BEFESTIGUNG NR. 1

Für Maschenweite 30 x 30 mm
Für Gitterroste bis 30 mm Höhe # 5/31

Werkstoff
Stahl feuerverzinkt
Edelstahl 1.4301



Stahl feuerverzinkt



Edelstahl 1.4301

■ STANDARD-BEFESTIGUNG NR. 4

Für Maschenweite 30 x 30 mm
Für Gitterroste bis 50 mm Höhe # 4/31

Werkstoff
Stahl feuerverzinkt



■ STANDARD-BEFESTIGUNG

Für Maschenweite 30 x 10 mm

Werkstoff	Typ
Stahl feuerverzinkt	# 20S/31*
Stahl feuerverzinkt	# 20S/31**
Stahl feuerverzinkt	# 23/31*

Für Gitterroste bis 30 mm Höhe*
Für Gitterroste bis 50 mm Höhe**



Typ 20S/31



Typ 23/31

Wir erweitern ständig unser Lagerprogramm, nicht aufgeführte Abmessungen sind auf Anfrage lieferbar.



■ **OBERTEIL NR. 4**

Für Maschenweite 30 x 30 mm
Bestehend aus: Teller D=51 mm, tiefgezogen

Werkstoff

Stahl feuerverzinkt



■ **OBERTEIL NR. 5**

Für Maschenweite 30 x 30 mm
Bestehend aus: Klammeroberteil

Werkstoff

Stahl feuerverzinkt



■ **OBERTEIL NR. 23**

Für Maschenweite 30 x 10 mm
Bestehend aus: U-Profil 22/28/2

Art.Nr.

3520050015

Werkstoff

Stahl feuerverzinkt

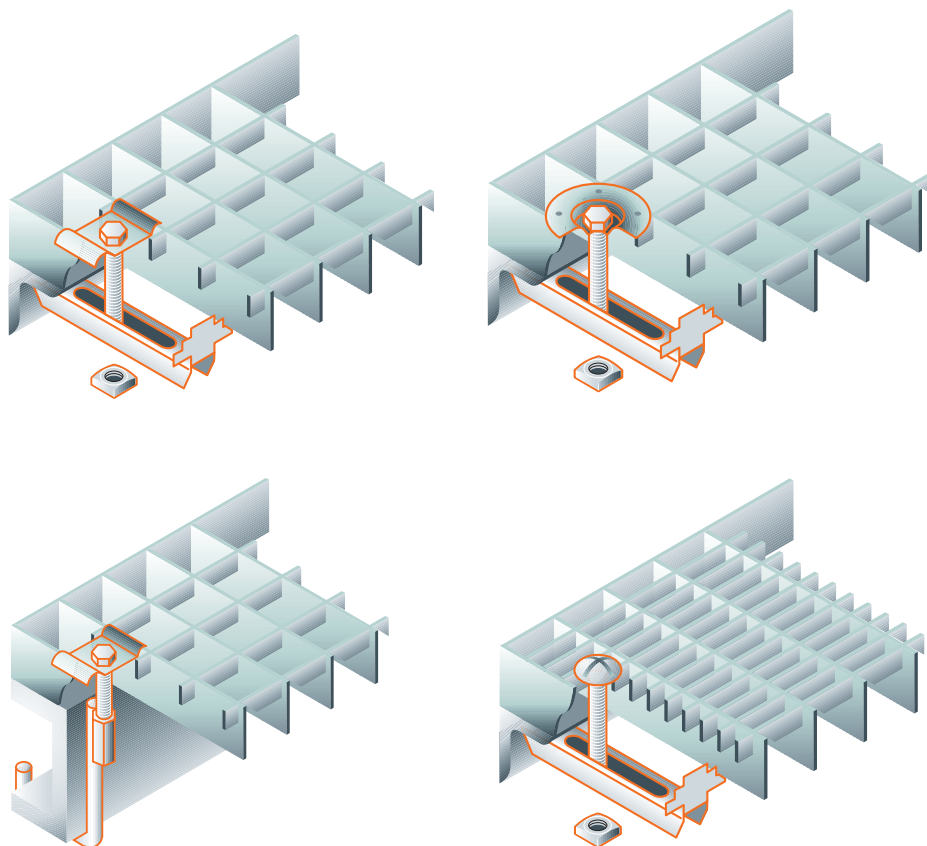

BELASTUNGSTABELLE

Begehbare Gitterroste bei einer max. Durchbiegung $f=4$ mm
Pressroste (ungeschwächter Querschnitt)
Tragstabteilung: 33,33 mm

Tragstababmessung	Max. Spannweite im Lichten bei einer Flächenlast von 5 KN/m ²	Max. Spannweite im Lichten bei einer Punktlast von 1,5 KN auf einem Lastwürfel 200 x 200 mm	Gewicht feuerverzinkt ca. kg/m ² MT 33/33
25 x 2 mm	1000 mm	840 mm	18,7
25 x 3 mm	1110 mm	960 mm	25,0
30 x 2 mm	1150 mm	1000 mm	21,5
30 x 3 mm	1270 mm	1150 mm	29,0
30 x 4 mm	1370 mm	1260 mm	41,9
30 x 5 mm	1440 mm	1360 mm	50,2
40 x 2 mm	1430 mm	1320 mm	27,0
40 x 3 mm	1580 mm	1520 mm	37,9
40 x 4 mm	1700 mm	1670 mm	52,9
40 x 5 mm	1790 mm	1800 mm	63,9
50 x 2 mm	1690 mm	1640 mm	37,4
50 x 3 mm	1870 mm	1880 mm	51,2
50 x 4 mm	2010 mm	2070 mm	69,9
50 x 5 mm	2120 mm	2230 mm	83,6
60 x 3 mm	2140 mm	2240 mm	64,4
60 x 4 mm	2300 mm	2470 mm	80,9
60 x 5 mm	2430 mm	2660 mm	97,4
70 x 3 mm	2400 mm	2600 mm	64,4
70 x 4 mm	2580 mm	2860 mm	83,9
70 x 5 mm	2730 mm	3080 mm	111,0
80 x 3 mm	2660 mm	2950 mm	75,7
80 x 4 mm	2860 mm	3250 mm	98,0
80 x 5 mm	3020 mm	3500 mm	124,8

Begehbare Gitterroste bei einer max. Durchbiegung $f=4$ mm
Pressroste (Rutschfeste Tragstäbe)
Tragstabteilung: 33,33 mm

Tragstababmessung	Max. Spannweite im Lichten bei einer Flächenlast von 5 KN/m ²	Max. Spannweite im Lichten bei einer Punktlast von 1,5 KN auf einem Lastwürfel 200 x 200 mm	Gewicht feuerverzinkt ca. kg/m ² MT 33/11	Gewicht feuerverzinkt ca. kg/m ² MT 33,3/16,65
25 x 2 mm	910 mm	670 mm	29,8	
25 x 3 mm	1010 mm	840 mm	35,9	
30 x 2 mm	1060 mm	900 mm	33,0	
30 x 3 mm	1170 mm	1030 mm	40,1	
30 x 4 mm	1260 mm	1130 mm		51,4
30 x 5 mm	1330 mm	1220 mm		59,8
40 x 2 mm	1340 mm	1230 mm	38,7	
40 x 3 mm	1490 mm	1400 mm	46,5	
40 x 4 mm	1600 mm	1540 mm		62,5
40 x 5 mm	1690 mm	1660 mm		73,7
50 x 2 mm	1610 mm	1550 mm	47,6	
50 x 3 mm	1780 mm	1770 mm	59,8	
50 x 4 mm	1910 mm	1950 mm		73,7
50 x 5 mm	2020 mm	2100 mm		87,6
60 x 3 mm	2060 mm	2130 mm	77,2	
60 x 4 mm	2210 mm	2350 mm		84,8
60 x 5 mm	2340 mm	2530 mm		101,5
70 x 3 mm	2330 mm	2490 mm	85,6	
70 x 4 mm	2500 mm	2740 mm		96,0
70 x 5 mm	2640 mm	2950 mm		115,5
80 x 3 mm	2580 mm	2840 mm	93,7	
80 x 4 mm	2770 mm	3130 mm		107,0
80 x 5 mm	2930 mm	3370 mm		129,4

Die dargestellten Werte sind berechnet nach ihrer maximal zulässigen Tragfähigkeit.
Technische Änderungen behalten wir uns vor.

■ **ROSTTYPEN**

■ **MIT T-EINFASSUNG**

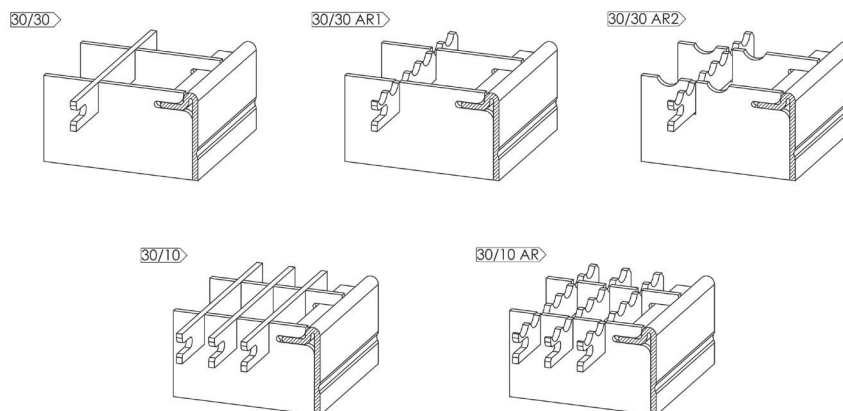

■ **MIT FLACHSTAHLEINFASSUNG**

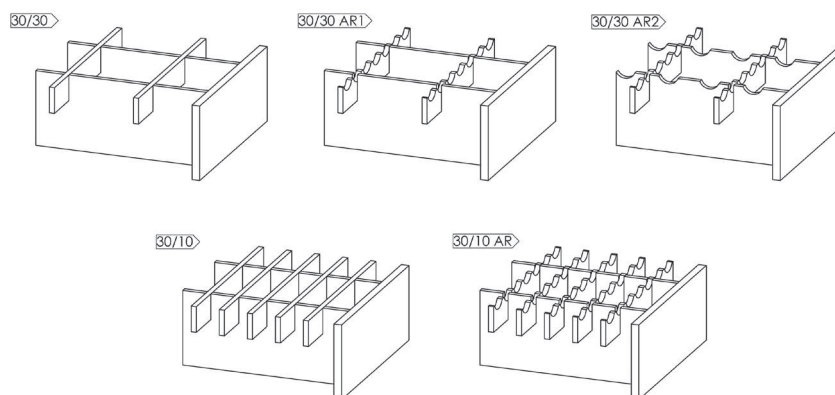

■ BLECHPROFILROSTE - EINE ÜBERSICHT

STEPBLOC D®

Durch die Zahnung der stark ausgeprägten Oberfläche besitzt der Rost eine sehr gute Stabilität und garantiert zusätzlich eine hohe Rutschhemmung, besonders in Bereichen, in denen mit Fett und Öl gearbeitet wird.

Stepbloc D ist durch eine gute Drainagewirkung für den Einsatz in der Industrie und Landwirtschaft, sowie im Fahrzeugbau und Bauwesen bestens geeignet.



FORMSTEP N®

Die kleinen nach oben und die großen nach unten ausgeprägten Lochungen verleihen dem Rost seine Stabilität. Zudem fördern diese Lochungen die hohe Rutschhemmung. Für den Einsatz im Außenbereich ist dies besonders vorteilhaft. Der Formstep N ist ideal geeignet für Treppen und Laufstege, ebenso für Maschinenbedienpodeste und Gerüstbohlen.

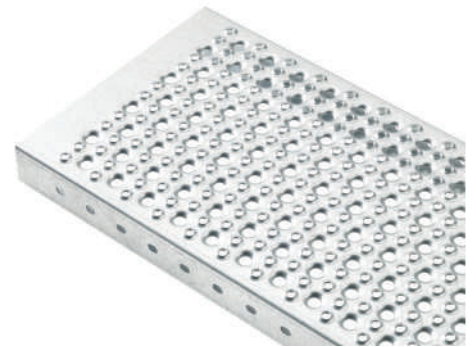

STEPCLAIR N®

Dieser Rost zeichnet sich durch seine rutschhemmende Oberfläche und seine hohe Drainagewirkung aus. Er findet Verwendung im industriellen Bereich auf Bedienpodesten, auf Laufstegen, als Treppenstufe und als Bohle im Gerüstbau.



STEPHUIT N®

Ein universell einsetzbarer Blechprofilrost, der sich aufgrund seiner Oberflächenbeschaffenheit durch gute Rutschsicherheit auszeichnet. Die Einsatzbereiche sind Laufstege in industriellen und, durch die sehr kleine Lochung, in öffentlichen Bereichen.



■ **LICHTSCHACHTABDECKUNG**



- Ultraflach, nur 5 mm
- Mit Edeltahlgewebe
- Rostfrei
- Farbe Ev1 eloxal
- Als Aufsatzversion
- Hohe Lichtdurchlässigkeit
- Auch mit Wandanschlussdichtungen
- Sonderlösungen auf Anfrage

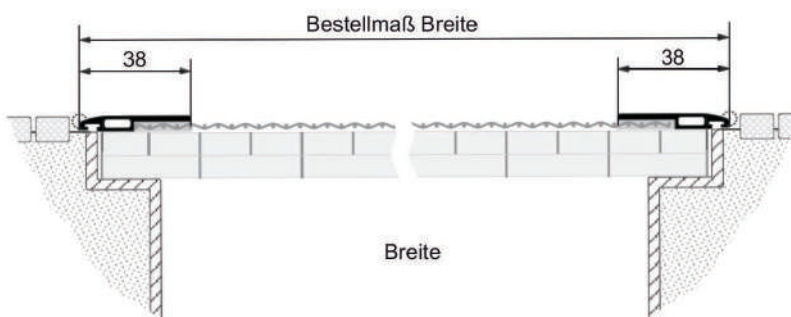

■ **GÄNGIGE RASTERMASSE**
ZWISCHENMASSE MÖGLICH

Die Lichtschachtabdeckung ist immer fertig zur Montage

	300	400	500	600	700	800	900	1000
300	X							
400	X	X						
500	X	X	X					
600	X	X	X	X				
700	X	X	X	X	X			
800	X	X	X	X	X	X		
900	X	X	X	X	X	X	X	
1000	X	X	X	X	X	X	X	X
1100	X	X	X	X	X	X	X	X
1200	X	X	X	X	X	X	X	X
1300	X	X	X	X	X	X	X	X
1400	X	X	X	X	X	X	X	X
1500	X	X	X	X	X	X	X	X

Keine Lagerware; nur als Sonderanfertigung lieferbar.

■ **SONDERZUBEHÖR**
WANDANSCHLUSSDICHTUNG



Wir erweitern ständig unser Lagerprogramm, nicht aufgeführte Abmessungen sind auf Anfrage lieferbar.

■ ÜBERSICHT ÜBER UNSERE SONSTIGEN LEISTUNGEN

SONDERANFERTIGUNGEN
GITTERROSTE UND TREPPENSTUFEN AUS:

- Stahl
- Edelstahl
- Aluminium
- GFK (Kunststoffroste mit Glasfasern verstärkt)

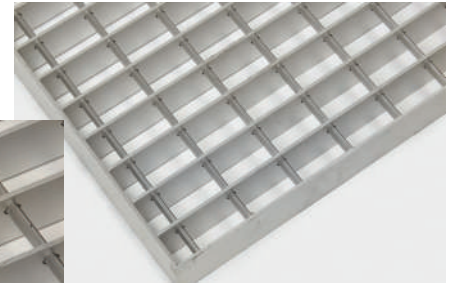

SONDERFORMEN MIT FOLGENDEN BESONDERHEITEN:

- runde oder eckige Ausschnitte
- Ausklinkungen
- Fußleisten
- Aufstelzungen
- Winkelkragen
- Gleitschutz

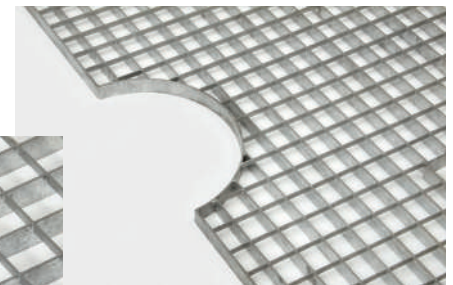
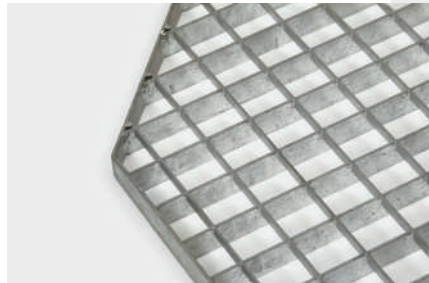

WEITERE PRODUKTE IN DER ÜBERSICHT:

- Pressroste
- Schweisspressroste
- Schwerlastroste
- Vollroste
- Jalousieroste
- INDURO Roste
- Blechprofilroste
- Treppenstufen
- Spindelstufen
- Winkelrahmen
- Befestigungs- und Sicherungselemente

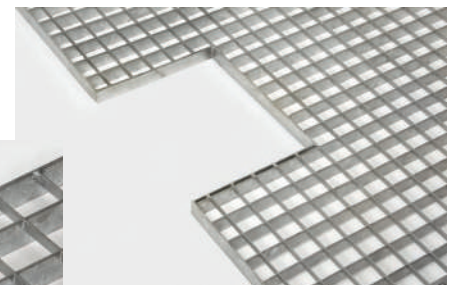
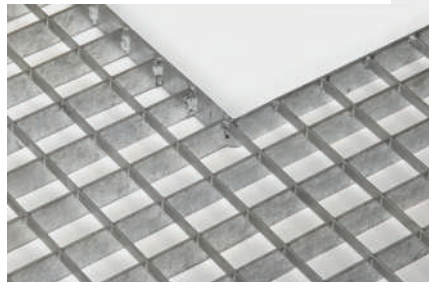

SONDERAUSFÜHRUNGEN:

- Barfußroste
- Baumroste
- Kammroste
- Lamellenroste
- Maschenteilung
variables Maschenbild durch Kombination von
Trag- und Füllstabteilungen
- Tragstäbe
Tragstabhöhe und -stärke für hohe Belastungen
und Stützweiten

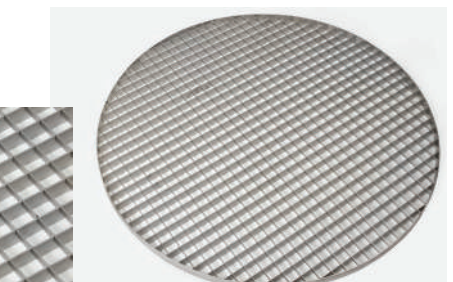

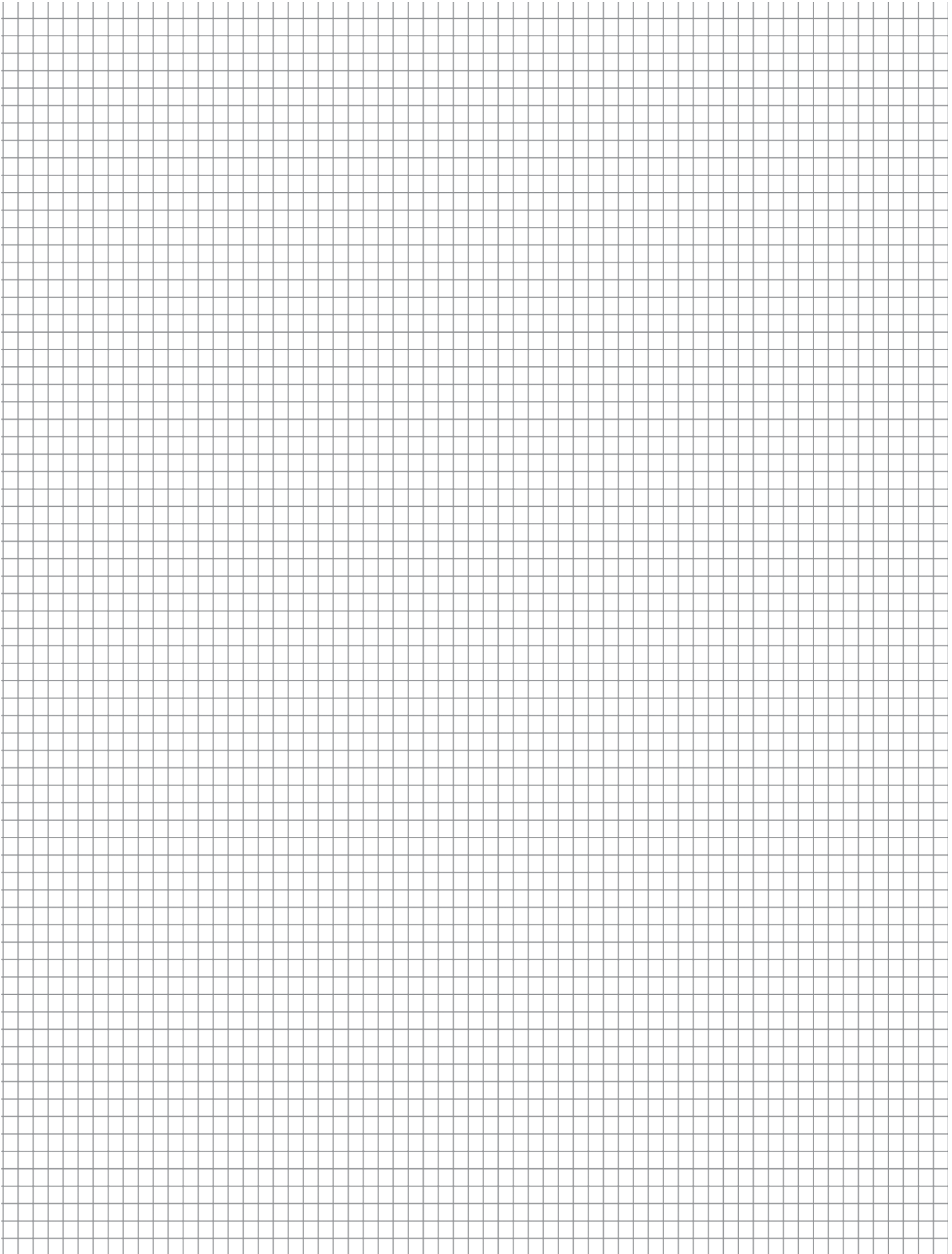

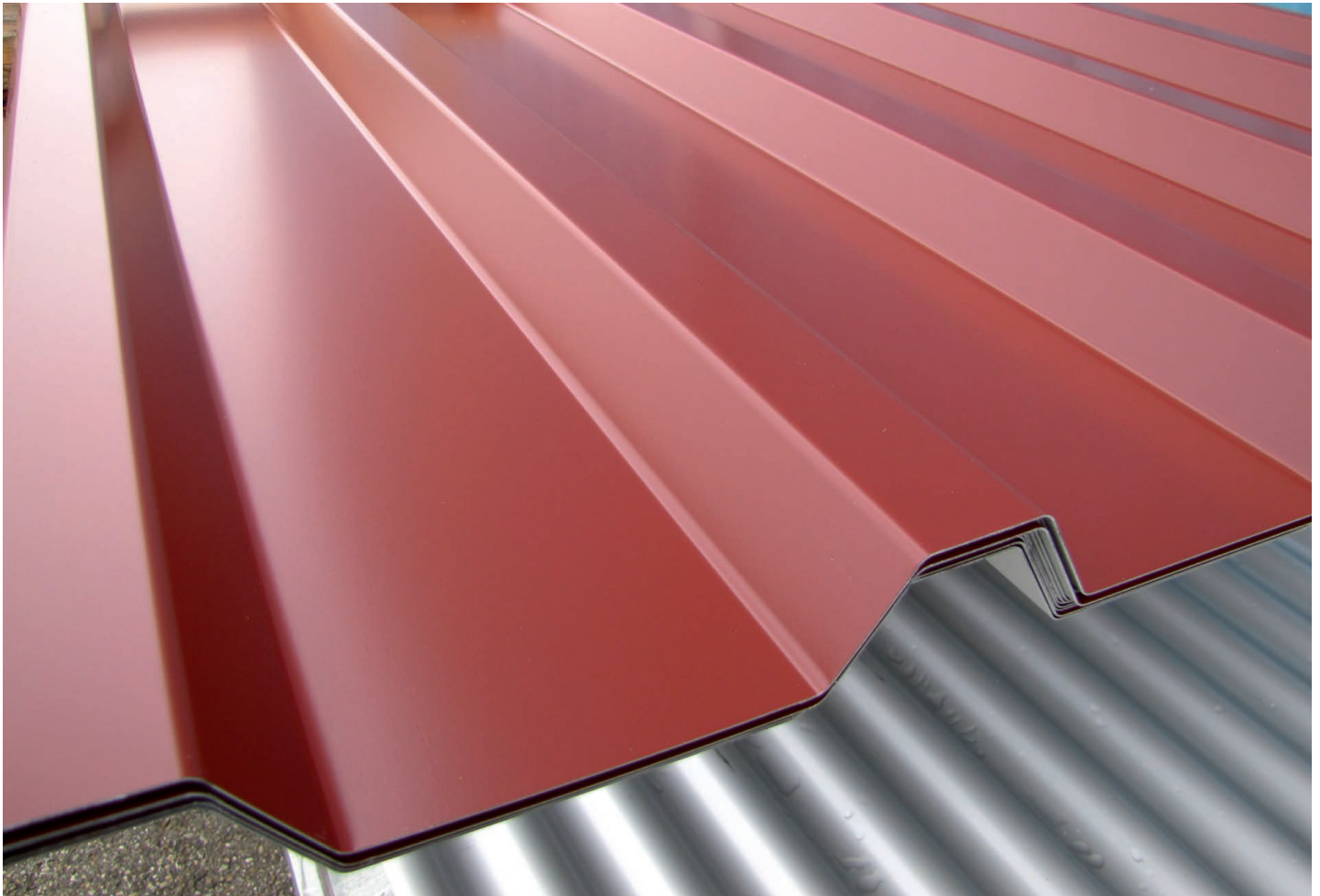

SANDWICHPANELEE UND TRAPEZBLECHE

SANDWICH-DACH „PENTA“ IN LÄNGEN BIS 18 METER

Oberschale 40-250/0,50 mm verzinkt, 25 my farbbeschichtet

Unterschale 0,50 mm verzinkt, 25 my ähnlich RAL 9002 (grauweiß)

Baubreite 1000 mm, B1-Dichtung

mit bauaufsichtlicher Zulassung Z-10.4-358

(Deutsches Institut für Bautechnik Berlin)

RAL 9006 (weißaluminium)
in der Kerndämmstärke **60 mm**

RAL 3009 (oxidrot/rotbraun)
in den Kerndämmstärken **40, 60 und 100 mm**

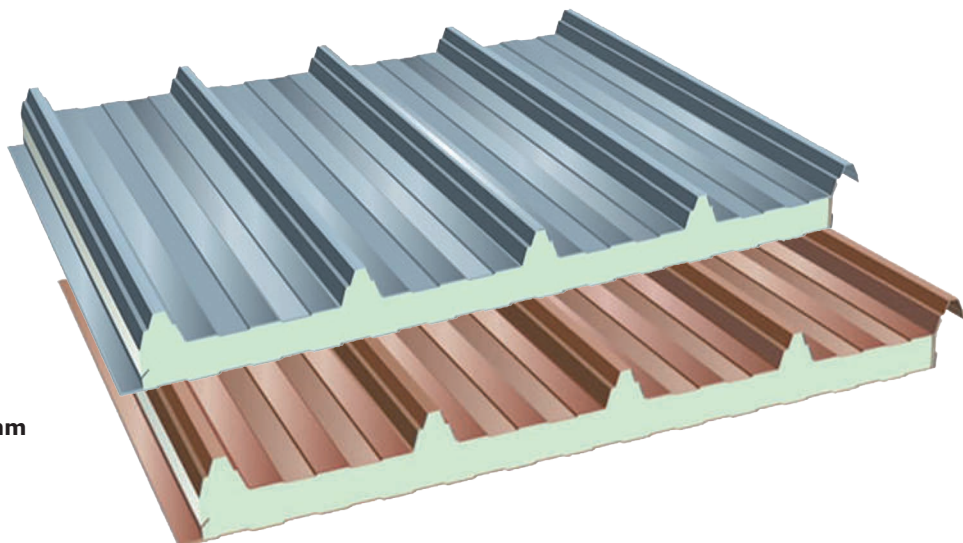

TECHNISCHE DATEN

Paneel-Typ		Penta PUR 40 mm	Penta PUR 60 mm	ISOCOP 5 PUR 100 mm
Paneeldicke		80 mm	100 mm	140 mm
Kernstärke		40 mm	60 mm	100 mm
Deckschicht- dicken	innen	0,5 mm	0,5 mm	0,5 mm
	außen	0,5 mm	0,5 mm	0,5 mm
Paneelgewicht (kg/qm) ca.		10,05 kg	10,85 kg	13,10 kg
Wärmedurchgangs- koeffizient (W/m² K)		0,498	0,342	0,209

BELASTUNGSTABELLE

System	Schneelast	Penta PUR 40 mm	Penta PUR 60 mm	ISOCOP 5 PUR 100 mm
	da N/qm	m	m	m
1-Feldträger	75	3,59	4,68	5,81
	125	2,60	3,33	4,60
	175	2,08	2,57	3,87
	225	1,76	2,10	3,12
2-Feldträger	75	3,35	3,63	4,12
	125	2,56	2,73	3,04
	175	2,08	2,26	2,48
	225	1,76	1,97	2,14
3-Feldträger	75	3,59	4,09	4,60
	125	2,60	3,06	3,38
	175	2,08	2,53	2,74
	225	1,76	2,10	2,36

Wir erweitern ständig unser Lagerprogramm, nicht aufgeführte Abmessungen sind auf Anfrage lieferbar.

■ SANDWICH-WAND „MEC“ IN LÄNGEN BIS 16 METER

40 mm PUR Kerndämmung
 beidseitig 0,50 mm verzinkt, außen und innen verwendbar
 Seite A: 25 my, ähnlich **RAL 9010** (reinweiß)
 Seite B: 25 my, ähnlich **RAL 9002** (grauweiß)
 Baubreite 1000 mm
 mit bauaufsichtlicher Zulassung Z-10.4-358
 (Deutsches Institut für Bautechnik Berlin)
 mit sichtbarer Befestigung

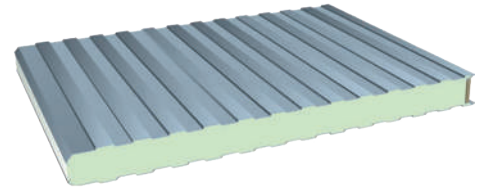

■ SANDWICH-WAND „ISOBOX“ IN LÄNGEN BIS 16 METER

80 mm PUR Kerndämmung
 beidseitig 0,50 mm verzinkt, außen und innen verwendbar
 Seite A: 25 my, ähnlich **RAL 9002** (grauweiß)
 Seite B: 25 my, ähnlich **RAL 9002** (grauweiß)
 Baubreite 1000 mm
 mit bauaufsichtlicher Zulassung Z-10.4-425
 (Deutsches Institut für Bautechnik Berlin)
 mit sichtbarer Befestigung

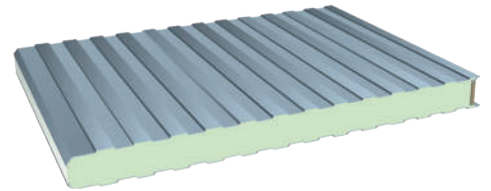

■ SANDWICH-WAND „SUPER-TOP“ IN LÄNGEN BIS 16 METER

65 mm PUR Kerndämmung
 beidseitig 0,50 mm verzinkt
 Seite A: 25 my, ähnlich **RAL 9006** (weißaluminium), microliniert
 Seite B: 25 my, ähnlich **RAL 9002** (grauweiß)
 Baubreite 1000 mm
 mit bauaufsichtlicher Zulassung Z-10.4-358
 (Deutsches Institut für Bautechnik Berlin)
 mit verdeckter Befestigung

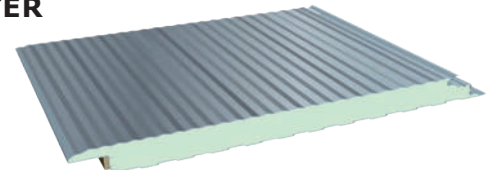

■ HART-PVC LICHTPLATTEN

für Profil 35-207
glashell, schlagzäh, oberflächenvergütet

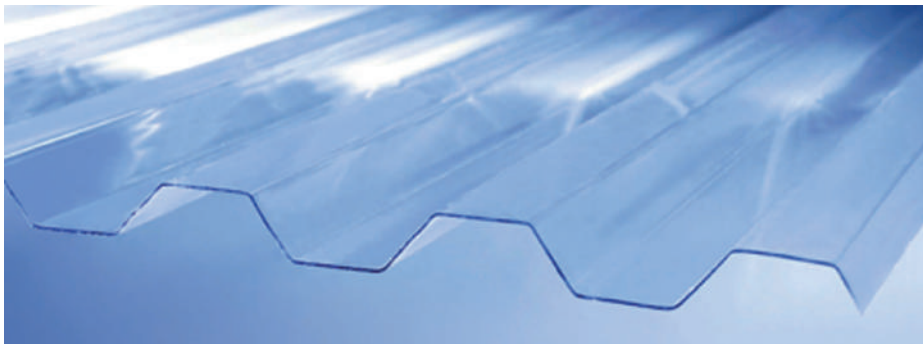

Länge mm	Breite mm	Stärke mm
3500	1035	1,2
5000	1035	1,2
6300	1035	1,2
7520	1035	1,2

■ POLYCARBONAT LICHT-STEGDREIFACHPLATTEN 16 mm

für Profil 40-250 (Penta/Isocop 5)
Wärmedurchgangskoeffizient 2,02 W/m²K

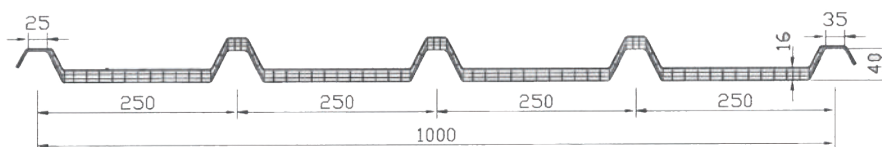

Länge mm	Breite mm	Stärke mm
5000	1000	16
6000	1000	16

Wir erweitern ständig unser Lagerprogramm, nicht aufgeführte Abmessungen sind auf Anfrage lieferbar.

STAHLTRAPEZPROFIL FÜR DACH

Profil 35-207/0,75 mm

bandverzinkt, einseitig 25 my Polyester

Dachseite: ähnlich **RAL 3009/8012** (oxidrot/rotbraun) (F2)

Unterseite: RSL = Rückseitenschutzlack (F1)

Baubreite 1035 mm

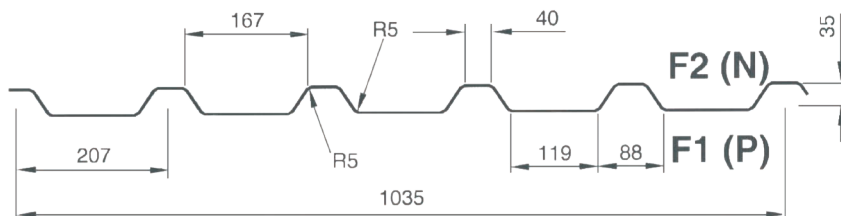

Länge mm	Breite mm	Stärke mm
2000	1035	0,75
2500	1035	0,75
3000	1035	0,75
3500	1035	0,75
4000	1035	0,75
4500	1035	0,75
5000	1035	0,75
5500	1035	0,75
6000	1035	0,75
6500	1035	0,75
7000	1035	0,75
7500	1035	0,75
8000	1035	0,75

STAHLTRAPEZPROFIL FÜR DACH UND WAND

Profil 35-207/0,75 mm

bandverzinkt, beidseitig 25 my Polyester

ähnlich **RAL 9002** (grauweiß)

Baubreite 1035 mm

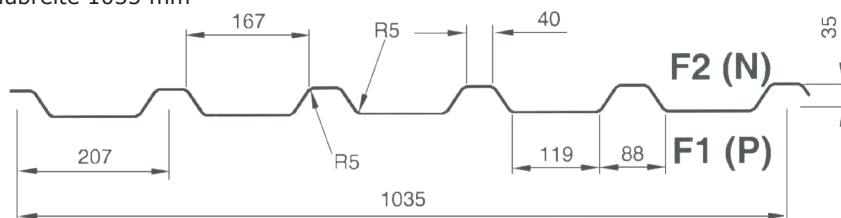

Länge mm	Breite mm	Stärke mm
3000	1035	0,75
4000	1035	0,75
5000	1035	0,75
6000	1035	0,75

Wir erweitern ständig unser Lagerprogramm, nicht aufgeführte Abmessungen sind auf Anfrage lieferbar.



■ **ALU-WELLE**

Profil 18-76/0,70 mm RAL 9006 weißaluminium

Baubreite Dach 991 mm

Baubreite Wand 1064 mm / Tafelbreite und Berechnungsbreite 1100 mm

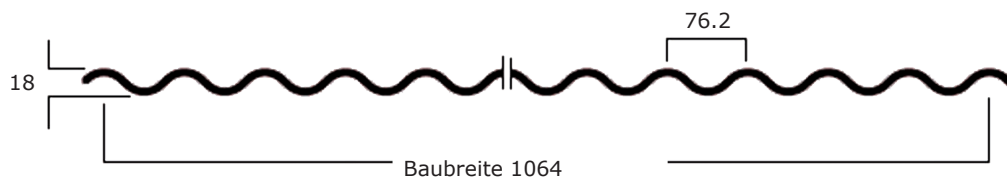

Länge mm	Breite mm	Stärke mm
2500	1100	0,70
3000	1100	0,70
4000	1100	0,70
5000	1100	0,70
6000	1100	0,70



■ **STAHL-WELLE BEIDSEITIG VERZINKT**

Profil 27-111/0,75 mm

Baubreite 1000 mm

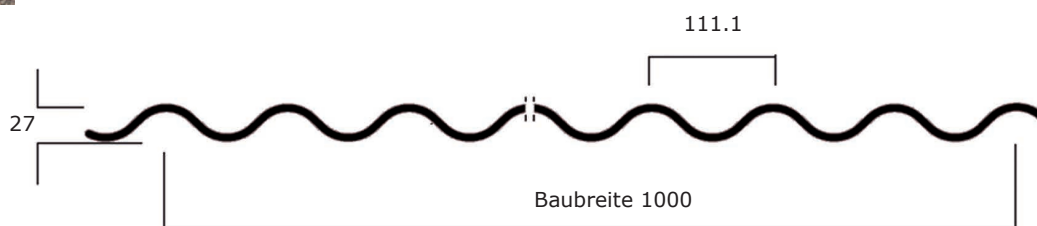

Länge mm	Breite mm	Stärke mm
2000	1000	0,75
2500	1000	0,75
3000	1000	0,75
3500	1000	0,75
4000	1000	0,75

Wir erweitern ständig unser Lagerprogramm, nicht aufgeführte Abmessungen sind auf Anfrage lieferbar.

EJOT DICHTSCHRAUBE JA 3

Unterkonstruktion Holz

- Edelstahl "Rostfrei"
- Abmessungen: **6,5** x 19/25/32/38/45/50/64/75/90/100/115/125/150/175/200 E16
- unverlierbar vormontierte Dichtscheibe
- zur Verschraubung von: Stahlprofilblechen, Aluminiumprofilblechen, Sandwichelementen, Faserzementtafeln, Holztafeln, Kunststofftafeln
- zur Verschraubung auf: Stahlunterkonstruktionen < 2,00 mm
Aluminiumunterkonstruktionen < 3,00 mm
Holzunterkonstruktionen
- Längsstoßverschraubung
- Mindesteinschraubtiefe: 52 mm



EJOT SUPER-SAPHIR KANTTEILSCHRAUBE

- Edelstahl "Rostfrei"
- Abmessungen: **5,5** x 25 E16
- unverlierbar vormontierte Dichtscheibe
- zur Längsstoßverschraubung von: Stahlprofilblechen, Aluminiumprofilblechen

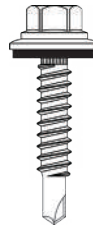

EJOT SUPER-SAPHIR BOHRSCHRAUBE JT 3

Unterkonstruktion Stahl 3.00 - 12.00 mm

- Edelstahl "Rostfrei"
- Abmessungen: **5,5** x 40/78/98/118/138/158/178/198 E16
- unverlierbar vormontierte Dichtscheibe
- zur Verschraubung von: Stahlprofilblechen, Aluminiumprofilblechen, Sandwichelementen
- zur Verschraubung auf: Stahlunterkonstruktionen 3,00 - 10,00 mm



EJOT SUPER-SAPHIR BOHRSCHRAUBE JT 3

Unterkonstruktion Holz

- Edelstahl "Rostfrei"
- Abmessungen: **6,5** x 50/65/80/100/120/140/160/180/200 E16
- unverlierbar vormontierte Dichtscheibe
- zur Verschraubung von: Stahlprofilblechen, Aluminiumprofilblechen, Sandwichelementen
- zur Verschraubung auf: Holzunterkonstruktionen, Stahlunterkonstruktionen < 1,25 mm
- Mindesteinschraubtiefe: 52 mm



Wir erweitern ständig unser Lagerprogramm, nicht aufgeführte Abmessungen sind auf Anfrage lieferbar.

■ **LAGERKANTTEILE IN LAGERVORRATSLÄNGEN 3 METER**

Abb. 1a + 1b



Abb. 2



Abb. 3

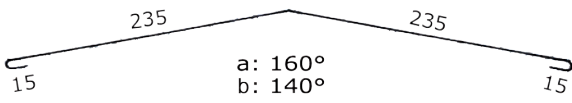

Abb. 4

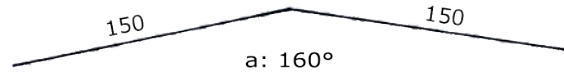

Abb. 5a + 5b

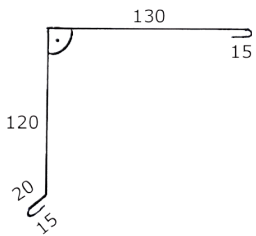

Abb. 6

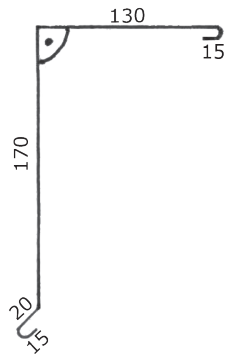

Abb. 7

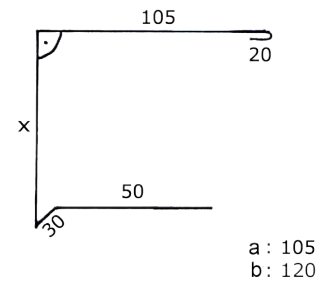

Abb. 8

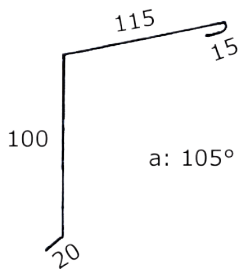

Abb. 9

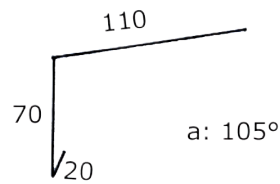

Abb. 10

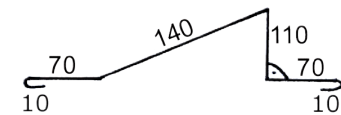

Abb. 11

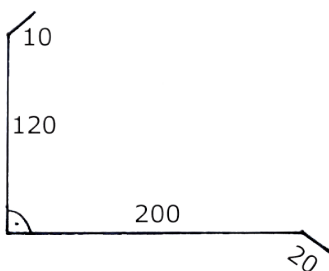

Wir erweitern ständig unser Lagerprogramm, nicht aufgeführte Abmessungen sind auf Anfrage lieferbar.

STAHLBLECHE ALS KLEINCOILS

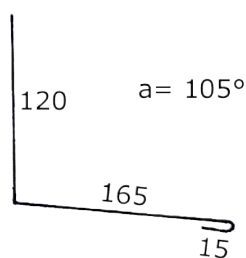
Länge mm	Breite mm	Stärke mm
20000	1250	0,75

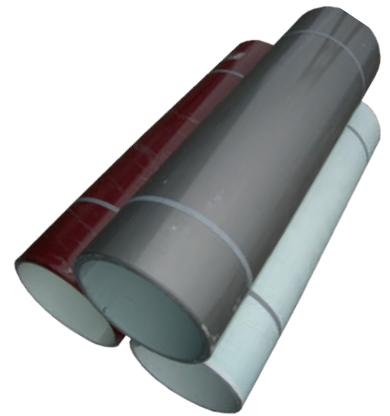

Oberseite: verzinkt, 25my ähnl. RAL ... mit Schutzfolie
Unterseite: Rückseitenschutzlack



RAL 1015 Hellelfenbein



RAL 6011 Resedagrün



RAL 8004 Kupferbraun



RAL 9001 Cremeweiß



RAL 9007 Graualuminium



RAL 7016 Anthrazitgrau



RAL 9002 Grauweiß



RAL 6005 Moosgrün

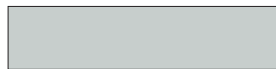

RAL 7035 Lichtgrau



RAL 8012 Rotbraun

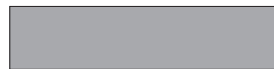

RAL 9006 Weißaluminium



RAL 3009 Oxidrot



RAL 8011 Nussbraun



RAL 9010 Reinweiß

STAHL - FLACHBLECHTAFELN

Länge mm	Breite mm	Stärke mm	Farbe
2500	1250	0,75	RAL 3009
3000	1250	0,75	RAL 3009
2500	1250	0,75	RAL 9002
3000	1250	0,75	RAL 9002
2500	1250	0,75	RAL 9006
2500	1250	0,75	RAL 7016



RAL 9002 Grauweiß

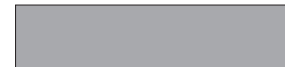

RAL 9006 Weißaluminium



RAL 3009 Oxidrot



RAL 7016 Anthrazitgrau

ALU - FLACHBLECHTAFELN

Länge mm	Breite mm	Stärke mm	Farbe
2500	1250	1,00	RAL 9006



RAL 9006 Weißaluminium

Wir erweitern ständig unser Lagerprogramm, nicht aufgeführte Abmessungen sind auf Anfrage lieferbar.

PROFILÜBERSICHT GÄNGIGER LIEFERBARER PROFILE

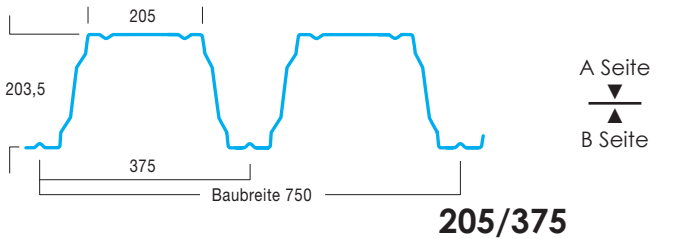
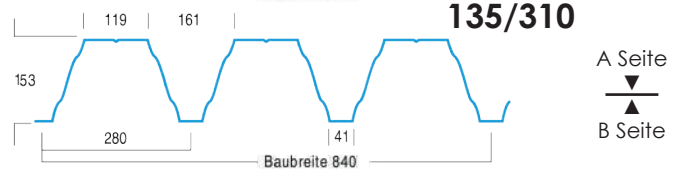
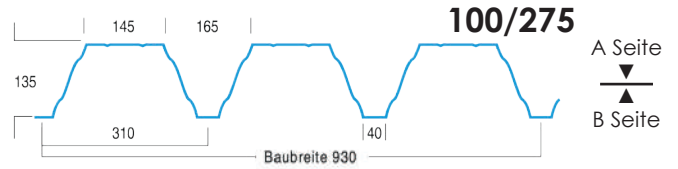
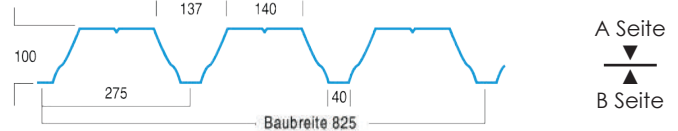
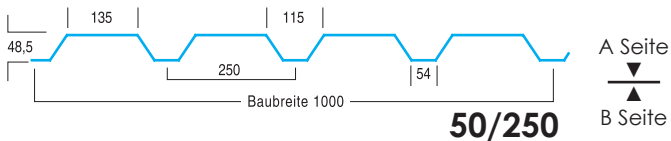
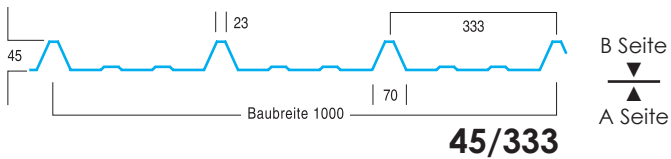
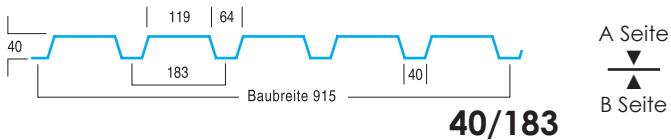
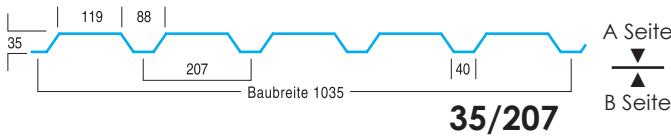
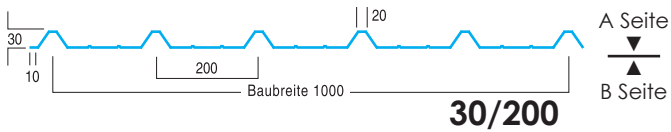
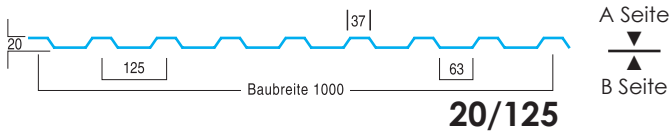
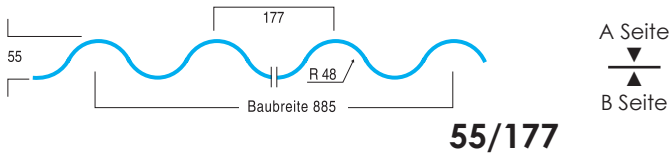
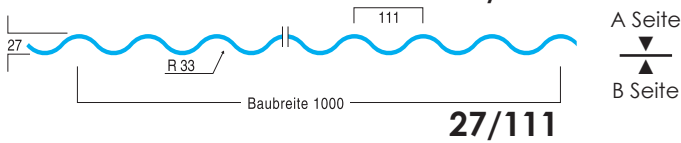
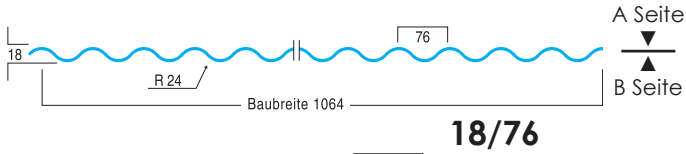

STANDARD-FARBMUSTER-STAHL FÜR TRAPEZBLECHE 0,75 MM

RAL 1014 Elfenbein



RAL 1015 Hellelfenbein



RAL 1019 Graubeige



RAL 3000 Feuerrot



RAL 3016 Korallenrot



RAL 6005 Moosgrün



RAL 6011 Resedagrün



RAL 7016 Anthrazitgrau

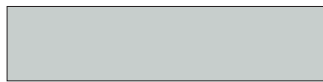

RAL 7035 Lichtgrau

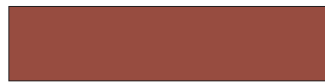

RAL 8004 Kupferbraun



RAL 8011 Nussbraun



RAL 8012 Rotbraun



RAL 8024 Beigebraun



RAL Cremeweiß



RAL 9002 Grauweiß



RAL 9006 Weißaluminium



RAL 9007 Graualuminium

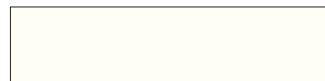

RAL 9010 Reinweiß



Verzinkt

Aus drucktechnischen Gründen ist eine Abweichung der Originaltöne möglich. Verbindlich für die RAL-Farben ist das Farbbregister RAL 840 HR.

KANTEILE NACH IHREN INDIVIDUELLEN WÜNSCHEN

Bei uns erhalten Sie Kanteile in verschiedenen Farben und Ausführungen nach Ihren individuellen Wünschen. Auch eine Fertigung nach Skizze ist für uns kein Problem.

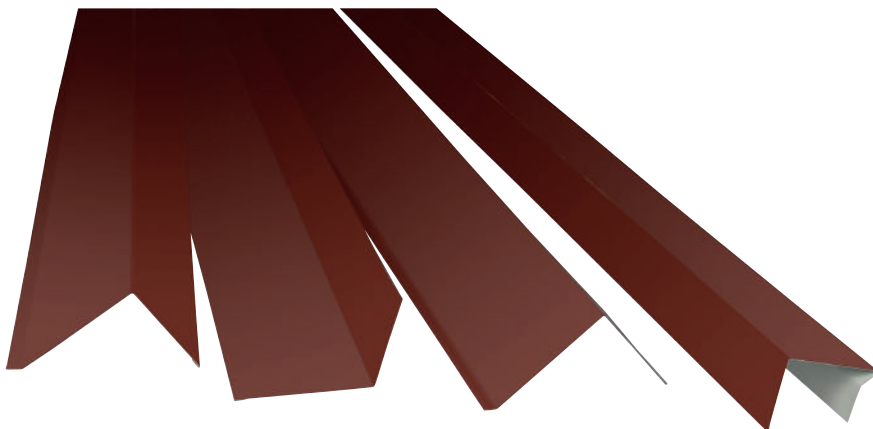

■ **SANDWICHELEMENTE MIT STEINWOLLDÄMMKERN
FÜR DACH UND WAND**

Dieses Bauelement zeichnet sich durch einen Kern aus Steinwolle und damit durch eine vollkommene Feuerfestigkeit und eine hervorragende Wärmedämmung aus.

Es wird den steigenden Anforderungen in Sachen Brandverhalten gerecht, ohne dabei mechanische Eigenschaften einzubüßen.



WANDELEMENT MEC

lieferbar in den Kerndämmstärken
50, 60, 80, 100, 120 mm



DACHELEMENT PENTA

lieferbar in den Kerndämmstärken
50, 60, 80, 100, 120 mm

Wir erweitern ständig unser Lagerprogramm, nicht aufgeführte Abmessungen sind auf Anfrage lieferbar.

ZUBEHÖR FÜR TRAPEZBLECH UND SANDWICHELEMENTE**DEKTITE ROHRMANSCHETTE**

Zur Abdichtung von Rohren auf Metalldächern.

**KALOTTEN ZUR OBERGURTBEFESTIGUNG VON PROFILBLECHEN**

Mit zentrisch angeordnetem Loch, aus Aluminium, in sämtlichen RAL-Farbtönen erhältlich.

**PROFILFÜLLERLEISTEN AUS PE-SCHAUM**

Zur Schließung von Trapezblech- und Wellprofilsicken sowie zur Wärmeisolierung und Schalldämmung.

**DICHTUNGSBÄNDER**

Vorkomprimierte Schaumstoffdichtungsbänder acrylatharzimprägniert, einseitig selbstklebend, in verschiedenen Abmessungen.



Wichtige Hinweise für Lieferung, Transport und Lagerung bei Aluminiumprofiltafel, verzinktem und kunststoffbeschichtetem Stahlblech und Lichtplatten

I. Anlieferung

Die Anlieferung erfolgt meist auf Paletten mit dem LKW.

Mit Rücksicht auf die Baustellenhebezeuge überschreitet das Gewicht einer Palette im Allgemeinen nicht 3 to.

Bei gestapelten Paletten liegen die mit Stahlband umreiften Holzauflagen übereinander.

Das Material ist stets vom Empfänger zu entladen. Bei Ankunft der Ladung ist sofort die Vollständigkeit und die Verpackung zu überprüfen und evtl. festgestellte Mängel am Material oder Beschädigungen dem Frachtführer in den Versandpapieren schriftlich zu vermerken.

Bei Vereinbarungen des Anlieferungstermins sind Wochenend-, Ferien- und Feiertagsfahrverbot zu beachten.

II. Lieferkonditionen

Preis frei Baustelle als komplette Ladung:

Bei Zusage eines konkreten Anliefertermins gilt es als vereinbart, dass sowohl der LKW als auch der Kran und die Monteur 2 Stunden ohne Berechnung warten.

Preis frei Baustelle als Beiladung:

Die Preisgestaltung bezieht sich auf die jeweilige Bestellung und berücksichtigt die Bestellmenge und Lieferlänge.

Bei Festlegung des Anliefertermins kann ein/e bestimmte/r Tag / Uhrzeit nicht zugesagt werden. Sofern jedoch eine bestimmte Uhrzeit gewünscht wird, müssen Frachtkosten wie bei einer kompletten Ladung berechnet werden.

Im Übrigen gelten unsere Allgemeinen Verkaufsbedingungen in ihrer neusten Fassung.

III. Transport / Entladen

Die Ladung soll trocken transportiert werden. Um bei offenem Transport ein Einregnen zu verhindern, ist die Ladung auf jeden Fall durch wasserundurchlässiges Material abzudecken – z.B. mit Zeltplanen, Teer- oder Ölpapier.

Das Material ist grundsätzlich mit Baukränen zu entladen.

Nur in Ausnahmefällen, z.B. bei kurzen Tafeln, ist der Einsatz von Gabelstaplern möglich.

Falls für die Aufnahme der Paletten durch den Kran keine speziellen „Traversen“ mit gummierten Hebebändern zur Verfügung stehen,

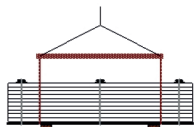

müssen bei Verwendung normaler Stahlschlagsteile Kantenschutzwinkel an die Paletten angelegt werden. Damit wird eine Beschädigung der Profiltafeln vermieden.

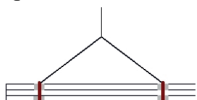

Die Paletten sollten möglichst nur durch Schwenken des Krans abgesetzt werden. Ein Fahren des Krans mit hängender Palette ist nicht zulässig.

IV. Lagerung

Bei Zwischenlagerung auf dem Dach ist darauf zu achten, dass die Dachkonstruktion nicht unzulässig belastet wird. Werden die Paletten auf geneigten Flächen abgesetzt, so sind diese gegen Abrutschen zu sichern.

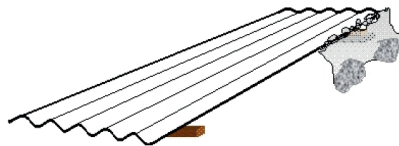

Bei längerer Lagerung sollen im Freien lagernde Paletten regendicht durch Planen – keinen falls durch Kunststoffolie – abgedeckt werden.

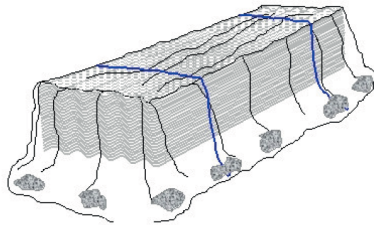

Die Paletten sollen in Längsrichtung leicht schräg gelagert werden, damit evtl. eingedrungenes Wasser ablaufen kann.

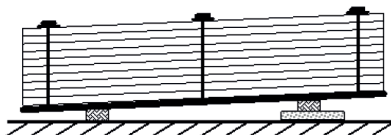

Werkseitige Palettenumhüllungen müssen zur Vermeidung von Kondensatbildung an den Enden geöffnet werden. Dies gilt auch für lackierte oder kunststoffbeschichtete Bauteile, da Kondensat zur Qualitätsminderung der Oberfläche führen kann.

Bei unsachgemäßer Lagerung ohne ausreichende Belüftung oder längerer Lagerdauer kann sich bei sendzimierverzinktem Material Zinkoxid oder Zinkhydroxid (Weißrost) bilden. Geringfügige „Weißrostbildung“ stellt keinen, die Gebrauchsfähigkeit des Bauteils mindern den Mangel dar.

Bei Aluminium-Profiltafeln kann sich bei unsachgemäßer Lagerung die Oberfläche verfärben.

Bei aufkaschierter Schutzfolie kann eine Versprödung eintreten. Sie kann dann nur mit größerem Aufwand entfernt werden. Nach dem Einbau muss die Schutzfolie daher sofort abgezogen werden.

Aluminium-Profiltafeln und farbbeschichtete Stahltrapezbleche sind durch Abdecken mit Planen gegen Baustellen-schmutz und mechanische Beschädigungen zu schützen.

V. Lichtplatten

Um Qualitätsminderungen bei Lichtplatten zu verhindern müssen folgende Lagervorschriften unbedingt eingehalten werden.

- Nicht im Stapel der Sonne aussetzen! (Hitzebau)

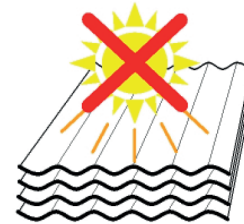

- Im Stapel vor direkter Sonneneinstrahlung durch helle lichtundurchlässige Abdeckung schützen!
- Nicht in der Nähe von Wärmequellen lagern!
- Auf der Baustelle: Lichtplattenstapel immer abgedeckt lassen!

VI. Nachbestellungen

WICHTIGER HINWEIS für Stahltrapezblech-Oberflächen:

Bei kunststoffbeschichteten (bandbeschichteten) Material sind bei Nachbestellungen Farbabweichungen möglich. Bei DU Dünnschichtungen und Rückseitenschutzlack kann ein gleichmäßiger einheitlicher Farbton wegen der geringen Schichtdicken nicht gewährleistet werden!

Diese Hinweise sind unbedingt einzuhalten! Sie sind Bestandteil des Kaufvertrages. Bei Nichteinhaltung kann kein Anspruch auf Wandelung, Minderung, etc. gewährt werden.

Allgemeine Montagehinweise für Trapez- und Wellprofile

Vor Montagebeginn sind die Vorgewerke Stahl-, Beton- oder Holzkonstruktionen auf die Maßhaltigkeit und Tragfähigkeit oder auf sonstige Abweichungen zu prüfen, soweit dieses mit dem Auge oder mit einfachen Hilfsmitteln z.B. Schnur, Bandmaß möglich ist.

An der Baustelle muss ein ausreichender und geeigneter Lagerplatz für die einzubauenden Profiltafeln und Zubehörteile zur Verfügung stehen. Die Pakete sind mit geeigneten Hebezeugen ggf. unter Verwendung von Traversen und Hebebändern zu transportieren.

Beim Absetzen der Pakete auf der Dachkonstruktion soll dieses im Bereich der Tragwerksstützen erfolgen.

Die Pakete sind gegen Abrutschen zu sichern.

Die jeder Lieferung beigefügten Beipackzettel sind zu beachten.

Das Verlegen der Profiltafeln hat im Allgemeinen nach den Verlegeplänen (kostenpflichtige Zusatzleistung) zu erfolgen. Um eine lot- und fluchtgerechte Verlegung der Montage zu erreichen, empfiehlt es sich die Rastermaße anzuzeichnen (3-4 Baubreiten des zu verlegenden Profils) und danach zu verlegen.

Die Verlegung der Profile hat immer gegen die Windrichtung zu erfolgen.

Die Profiltafeln sind immer beidseitig gleichmäßig aus den Paketen zu heben und müssen zur Verlegeposition getragen werden, sie dürfen nicht über die Unterkonstruktion gezogen oder geschoben werden.

Vor jeder Arbeitsunterbrechung sind die verlegten Profile auf den Auflagern zu befestigen.

Bei auskragenden Dachprofilen ist aus Sicherheitsgründen jede Profiltafel sofort nach der Verlegung zu befestigen. Geöffnete Pakete sind bei Arbeitsende gegen Sturm und Abrutschen zu sichern.

Auflagerbreiten nach DIN 18807 Teil 3

Art der Unterkonstruktion	Stahl/ Stahl- beton	Mauer- werk	Holz
Endauflagerbreite b_a min	40 mm	100 mm	60 mm
Zwischenaflagerbreite b_B min	60 mm	100 mm	60 mm

Überdeckung der Profile am Querstoß

Die Überdeckung der Profiltafeln mit oberseitiger Abdichtung ist mit einer Länge von 50 mm bis 150 mm je nach Profil und Spannweite auszuführen.

Bei Verwendung der Profile als Dacheindeckung (wasserführend) ist die Überdeckung in Abhängigkeit von der Dachneigung zu wählen.

Überdeckungen der Querstöße nach DIN 18807 Teil 3

Dachaufbau		Überdeckungslänge (mm)
Trapezprofile mit oberseitiger Dachabdichtung		50-100
Profile als Dachdeckung wasserführend		ohne Querstoß
Grad	Prozent	
bis 3	< 5	
3-5	5-9	
5-20	9-36	
über 20	> 36	100

Längsstoßausbildung

Bei Dächern mit oberseitiger Dachabdichtung liegt die Längsstoßüberlappung unten.

Werden Trapez- und Wellprofile als wasserführende Dacheindeckung eingesetzt, ist wegen der Regen- und Schneedichtigkeit die Längsstoßüberlappung oben, sie sind entgegen der Windrichtung zu montieren.

Bei Dachneigungen unter 7° sind die Längsstoßüberdeckungen mit einem durchlaufenden Dichtband vorzusehen.

Befestigung der Profiltafeln auf der Unterkonstruktion und die Verbindungen untereinander. Im Allgemeinen erfolgt die Befestigung entsprechend den statischen Nachweisen und Angaben in den Verlegeplänen (kostenpflichtige Zusatzleistung).

Profiltafeln werden grundsätzlich in jedem 2. Gurt an der Unterkonstruktion befestigt, an First und Traufe in jedem Gurt. Eck- und Randbereiche sind zusätzlich gegen Windsogkräfte zu sichern.

Ausgenommen von dieser Regelung ist das Profil 45/333. Durch das große Rastermaß von 333 mm ist eine Befestigung in jedem Gurt erforderlich.

Die Längsstoßüberlappungen sind im Abstand von 666 mm miteinander zu verbinden.

Ausgenommen von dieser Regelung ist das Wurzer Profil 45/333 und 30/200. Bei diesen Profilen ist nach den Bedingungen des „Allgemeinen bauaufsichtlichen Prüfzeugnisses“ Nr. P-2004-2017 vom 10.12.2004 eine Befestigung des Längsstoßes nicht erforderlich.

Beim Einsatz von Profiltafeln als wasserführende Dachdeckung sind nichtrostende mit Dichtscheiben versehene Schrauben einzusetzen. Es dürfen nur zugelassene Verbindungsmittel verwendet werden.

Es wird empfohlen die Verschraubungen auf den Wellenbergen der Profile unter Verwendung von Kalotten vorzunehmen. Um ein Eindellen der Profile durch die Schrauben zu verhindern, empfiehlt es sich mit Drehmoment abhängigen- oder mit Tiefenanschlag versehenen Schraubern zu arbeiten.

Bei größeren Tafellängen beginnt man mit der Verschraubung von der Mitte aus um evtl. auftretende Spannungen zu vermeiden.

Die Wärmeausdehnung der einzusetzenden Materialien ist zu berücksichtigen.

Für lange Aluminiumtafeln (über 6m Länge) müssen aufgrund der zu erwartenden Ausdehnung entsprechende Vorkehrungen getroffen werden.

Empfohlene Schraubenlängen:

Für das Profil 35/207 bei Befestigung auf Holz

6,5 x 75	
40/183	6,5 x 90
45/333	6,5 x 90
50/250	6,5 x 100

Bei wasserführender Trapezprofileindeckung sind an der Traufe die Untergurte leicht nach unten in Richtung Dachrinne und am First leicht nach oben zu kröpfen.

Schnitte an Profiltafeln und Kantteilen sind mit geeigneten Werkzeugen, Scheren, Nibbler oder Knabber auszuführen (Kaltschnitte).

Aluminium Profiltafeln dürfen während der Dachmontage und nach erfolgter Montage nur unter Anwendung lastverteilender Maßnahmen z.B. Holzbohlen begangen werden.

Für Eindeckungen mit Antitropfbeschichteten Profilen (Vlies) empfehlen wir einen ca. 100 mm breiten Verhärtungsanstrich der Vliesfolie am Traufenende bzw. bei Querstößen mit einem dafür geeigneten Lack vorzunehmen.

Nach Fertigstellung der Montagearbeiten sind alle Bohr- und Schneidspäne von Profilen aus Dachrinnen, von Fensterbänken und Tropfblechen zu entfernen.

Dachflächen sind nur mit geeignetem Schuhwerk zu begehen.

Für die Montage von Trapez-Wellprofilen ist die DIN 18807 zu beachten.

